

Macworld Gaming Guide: 3-D Card Shoot-Out

J A N U A R Y 1 9 9 9

Macworld

CD INSIDE
FULL TRIAL VERSIONS
CYBERSTUDIO PRO 3
CANVAS 6

THE ESSENTIAL MACINTOSH® RESOURCE
www.macworld.com

POWERBOOK G3 SUPERGUIDE

Top Mobile Secrets

Essential Add-Ons

MACWORLD PICKS

The Best Portable
Projectors

REVIEWS

Illustrator 8.0

Epson Stylus Color 740 Printer

Norton Utilities for Mac 4.0

Professional Shareware

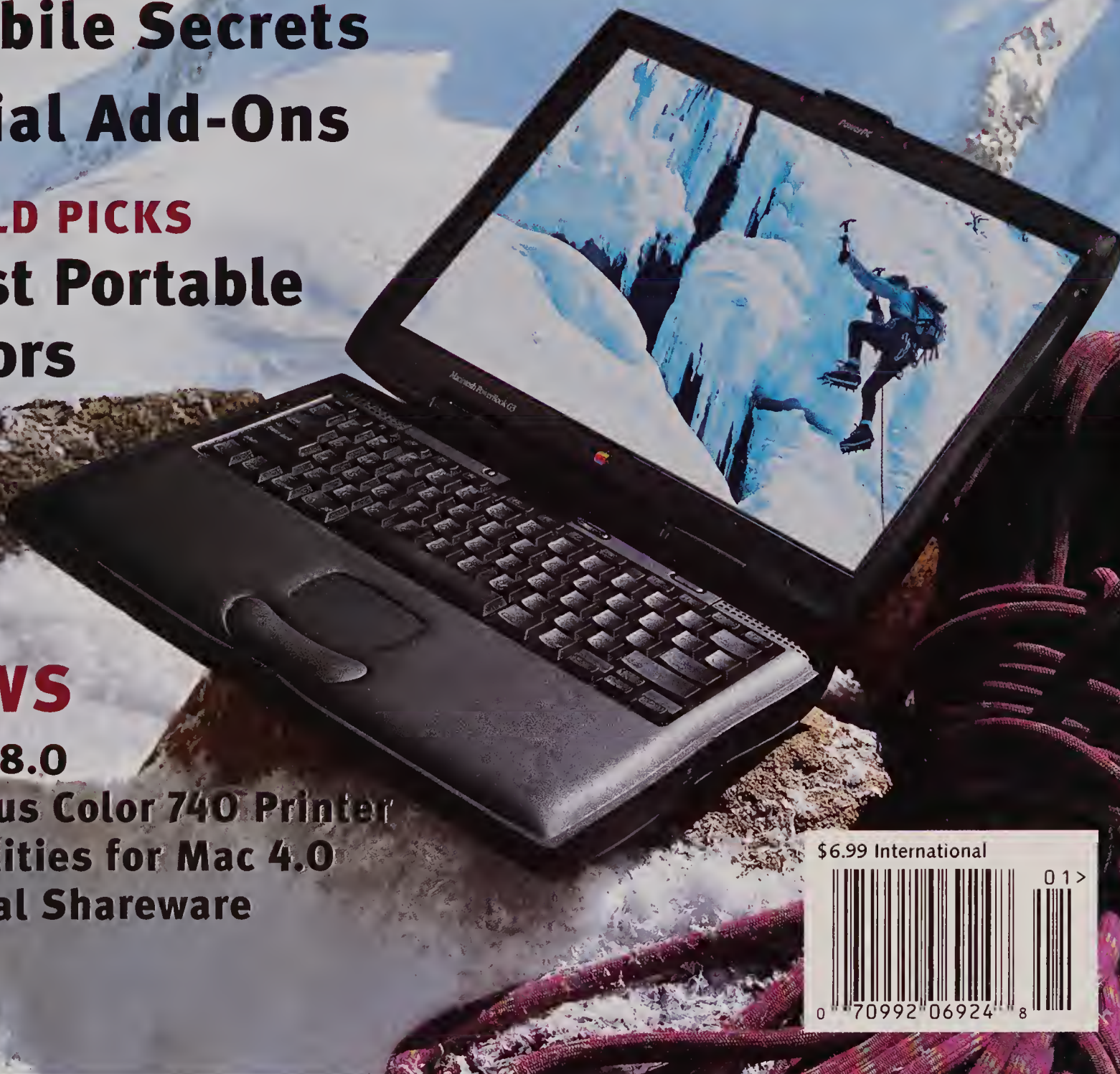

\$6.99 International



The world's most advanced
It's on your



search tool isn't on the Web. Macintosh.

How in the world do you find what you need on an Internet that gets more complex every second? Well, if you have a PowerPC™-based Macintosh, the answer is easy: Upgrade to Mac OS 8.5

Sherlock

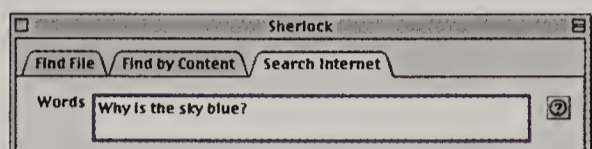

What in the world are you looking for? Sherlock understands plain, simple English – no need to type in strange symbols.

with Sherlock™, the Internet search detective. Just type in your request – in plain English – and Sherlock unleashes a cadre of the Internet's most powerful

search engines simultaneously. In just seconds, the results begin to stream onto your screen, dynamically ranked by relevance. Then, all you have to do is click on any item and off you go. Sherlock starts out powerful, then gets even more powerful – because you can download free “plug-ins” that expand Sherlock's reach to other search engines and all kinds of Internet content, from news centers to retailers. And it doesn't stop with the Internet. Sherlock is so clever in the way it searches, it can also find files that are hidden within your hard disk, by title or by content. So it's easy to locate documents even if you can only remember a key word or phrase. If you're searching for faster



You can expand Sherlock's reach with over a hundred free Sherlock plug-ins now available on the Internet for news, music, sports, you name it.

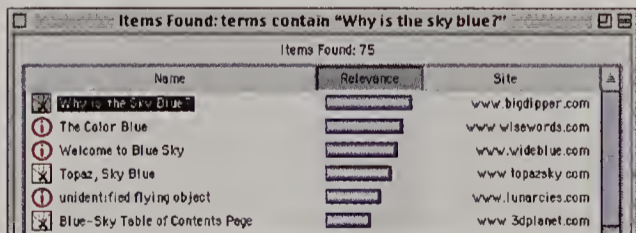

Sherlock unleashes the power of several search engines at once and reports back in seconds – dynamically ranking results by relevance.

and better ways to use your

Macintosh computer, stop by and pick up your copy of the new Mac OS 8.5 at an authorized Apple reseller (call 1-800-538-9696 for locations) or visit the Apple Store™ at

www.apple.com. For only \$99*, it's like putting a powerful new Macintosh inside the Mac you already own.



Think different.™

*Estimated retail price. Tax not included. Requires Mac OS-based Apple computer with PowerPC processor and 16MB of physical RAM, with virtual memory set to at least 24MB. Apple PC Compatibility Cards not supported. Internet access requires ISP. © 1998 Apple Computer, Inc. All rights reserved. Apple, the Apple logo, Mac, Macintosh and Think different are trademarks of Apple Computer, Inc., registered in the U.S. and other countries. The Apple Store and Sherlock are trademarks of Apple Computer, Inc. PowerPC is a trademark of IBM Corp., used under license therefrom. Other product and company names mentioned herein may be trademarks of their respective companies. Mention of third party products is for reference only and constitutes neither recommendation nor endorsement.



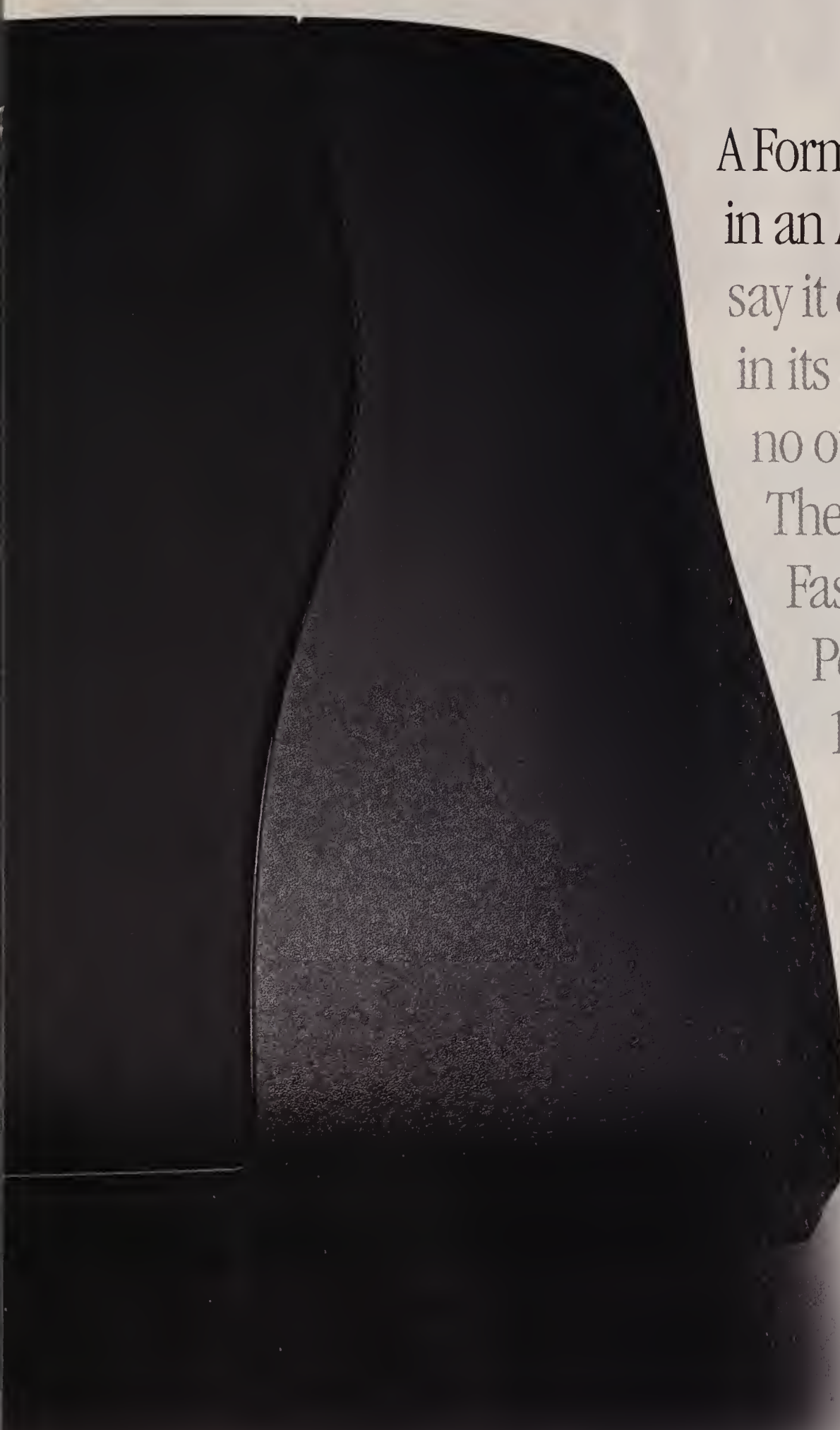

A Formula One race car
in an Armani suit. We'd
say it outperforms others
in its class, but there are
no others in its class.

The PowerBook® G3.

Faster than any

Pentium notebook.*

14.1-inch screen.

Fully configured.

Starts at \$2,799.¹

www.apple.com.



Think different.®

Macworld

Incorporating MacUser

Features

Cover Story

The PowerBook Field Guide

70

If you're a globe-trotting graphics pro, itinerant executive, or post-modern digital nomad, read our expert guide for perfecting the lifestyle of a peripatetic Mac user.

73

Survival Skills

BY DAVID POGUE Learn expert strategies for living a happy and harmonious life in transit with your PowerBook.

79

Road Gear

BY STEPHAN SOMOGYI Discover a wealth of add-on goodies to make your trusty PowerBook more travel-savvy.

83

Traveling Light

LAB TEST

BY JEFF PITTELKAU Featherweight portable projectors really lighten the load for roving presenters. Macworld Lab tests six "ultra-portables" to help you select a worthy travel partner.

88

Serious Shareware

BY JOHN FU AND PHILIP DYER Outfit your Mac with a battalion of powerful grass-roots software—or complement your commercial arsenal—on a miser's budget.



On the road again? Make the trip easier with our traveler's field guide, page 70.

Create

Graphics

107 A Strong Batch of DeBabelizer

BY JIM HEID Harness the automation power of Equilibrium's batch-processing image-manipulation utility.

Web

111 Bring Buttons to Life in Flash 3

BY KATHERINE ULRICH Make flashier Web buttons with Macromedia's snazzy little vector animator.

Motion

115 Mastering Adobe Premiere 5

BY JIM HEID Learn expert techniques to show Adobe's formidable video-editing tool who's the boss.

MACWORLD ULTIMATE GAMING GUIDE

183

Comin' at Ya

LAB TEST

BY CHRISTOPHER BREEN Three-dimensional games require more juice to jam, but is your hardware up to snuff? Macworld Lab helps you determine which 3-D-acceleration cards give good game.

190

The Game Room

BY PHILIP DYER The unvarnished truth about playing PC games on your Mac.





Stamp out Office 98 troubles, page 95.

Opinion

17 Letters

29 The Vision Thing

BY ANDREW GORE Throw off the shackles of cubicle life.

192 The Desktop Critic

BY DAVID POGUE Lo, reports of Mac phaseouts have been greatly exaggerated.

12 How to Contact Macworld

News

35 G4 Set to Take Flight

Motorola formally announces its next-generation G4 CPU with speedy AltiVec technology.

36 Spinning a Dynamic Web

Macromedia, GoLive, and Adobe Systems spruce up their Web authoring programs.

37 An Upscale New Canvas

SpriteLayers technology in Deneba Canvas 6 lets you mix vector and raster graphics.

37 Product Watch

The latest products for your Mac, including a new mouse for your iMac and software that lets you create double-byte fonts.

38 Color Lasers Do Graphics

Hewlett-Packard and Tektronix transform color laser printers from corporate stalwarts to graphics-studio sidekicks.



A new "launchpad" for your graphics, page 45.

Secrets

95 Keep Your Office Running Smoothly

BY TED LANDAU How to cope when Microsoft Office 98 starts misbehaving.

97 Quick Tips

BY LON POOLE Tips, tricks, and shortcuts.

Reviews

- 42 **★★★★½** Adobe Illustrator 8.0
Illustration software
- 44 **★★★★** Epson Stylus Color 740
Ink-jet printer
- 45 **★★★** Wacom Intuos
Drawing tablet
- 46 **★★** Norton Utilities for Mac 4.0
Disk-repair software
- 48 **★★★★½** EdgeWizard;
★★★★ Extensis Mask Pro 2.0;
★★★★ Ultimatte KnockOut
Photoshop masking utilities compared
- 50 **★★★** ix3D Mac Rocket;
★★★ ix3D Pro Rez;
★★★★ Vision3D Pro II Lite
Graphics accelerators compared
- 52 **★★★★** MacLinkPlus Deluxe
File-translation utility
- 54 **★★★★** Conversions Plus 4.5;
★★★★½ MacOpener 4.0
Mac-disk-mounting utilities for Windows
- 56 **★★★★** LinkUPPP Turbo 3.0.2
Multichannel PPP software
- 56 **★★★★½** VivoActive VideoNow 3.0
Streaming-video software
- 58 **★★★★** Vpower PM 4400 G3/240
CPU-upgrade card
- 60 **★★★★** ElectricImage 2.8
Professional 3-D animation software
- 61 **★★★** Frontier 5.1.4
Content-management/scripting software
- 62 **★★★★** Profiler 1.1
Color-profiling tool
- 62 **★★** Natural Scene Designer 2.0
3-D-terrain generator
- 63 **★★★★½** PageSentry 2.5
Web-server-monitoring utility
- 64 **★★★★** ReBirth RB-338 2.0
Music-synthesizer software
- 66 **★★★★** Mars Rising
Shoot-'em-up game

ON THE COVER

Photograph by Mark Johann;
mountain and screen images
by Image Bank



Motorola's G4 chip is officially off the ground, page 35.

BUY YOUR MAC FROM APPLE
BUY YOUR PRINTER
DIRECT FROM GCC.



HERE'S WHY...



We're GCC Technologies and our printers are sold direct against some of the most famous names in the computer industry. Which creates a buying opportunity for those who understand a basic principle of free enterprise: Selling direct is better for the manufacturer and buying direct is better for the customer.

Therefore, we sell our printers direct, eliminating many prosperous middlemen, and lowering your costs.

We also provide direct technical support, eliminating other middlemen who can't solve your problems. And we are compassionate hand-holders. We offer unlimited free technical support, not just on business days, but on Saturdays too – throughout the one-year warranty period. And if during that period you have a problem that our technical support people can't solve, our Platinum Exchange program guarantees you a replacement printer by the next business day.

We invite you to buy your next printer direct from GCC and join our growing family of satisfied customers. All GCC printers come with an unconditional thirty-day money-back guarantee.

For complete details, call the 800 number below. And for the record, yes, our printers have wonderful technology too. It's just that you don't have to pay extra for it.

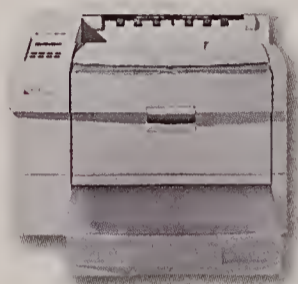

ELITE 12 Series

12 pages per minute
 1 year Platinum Exchange Warranty
 Maximum Print Area 8.5" x 14"
 Letter/A4, legal, envelope
 250 sheet Universal Tray
 PostScript® Level 2 compatible, PCL 5
 80 PostScript fonts, 15 PCL fonts
 RAM expandable to 64 MB
 EtherTalk®, LocalTalk®, TCP/IP
 Ethernet (10BaseT), Bi-directional Parallel
 2nd Paper Feeder*
 (Includes 500 sheet Universal Tray) Add \$299

Extra 8 MB Memory Add \$ 49

\$999 **600 dpi**
 Business Lease \$35 Month/36 months**

Platinum Exchange Warranty Program
 Additional Year Add \$ 99

\$1199 **1200 dpi**
 Business Lease \$41 Month/36 months**

Platinum Exchange Warranty Program
 Additional Year Add \$ 119

ELITE XL 20 Series

20 pages per minute
 1 year Platinum Exchange Warranty
 Maximum Print Area 12.75" x 35.25"
 Letter/A4, tabloid/A3, envelope, legal, poster
 500 sheet Universal Tray
 PostScript® Level 2 compatible, PCL 5
 285 PostScript fonts, 15 PCL fonts
 RAM expandable to 64 MB
 EtherTalk®, LocalTalk®, NetWare™, TCP/IP
 Ethernet (10BaseT, AAUI), Bi-directional Parallel
 2nd or 3rd Paper Feeder*
 (Includes 500 sheet Universal Tray) Add \$299

Extra 8 MB Memory Add \$ 49

\$1799 **600 dpi**
 Business Lease \$63 Month/36 months**

Platinum Exchange Warranty Program
 Additional Year Add \$ 179

\$1999 **800 dpi**
 Business Lease \$70 Month/36 months**

Platinum Exchange Warranty Program
 Additional Year Add \$ 199

\$2199 **1200 dpi**
 Business Lease \$75 Month/36 months**

Platinum Exchange Warranty Program
 Additional Year Add \$ 219

ELITE XL 8 Series

8 pages per minute
 1 year Platinum Exchange Warranty
 Maximum Print Area 11" x 17"
 Letter/A4, tabloid/A3, envelope, legal,
 250 sheet Universal Tray
 PostScript® Level 2 compatible, PCL 5
 80 PostScript fonts, 15 PCL fonts
 RAM expandable to 64 MB
 EtherTalk®, LocalTalk®, TCP/IP
 Ethernet (10BaseT, 10Base2), Parallel
 2nd Paper Feeder*
 (Includes 250 sheet Universal Tray) Add \$319
 (Includes 500 sheet Universal Tray) Add \$419

Extra 8 MB Memory Add \$ 49

\$1399 **600 dpi**
 Business Lease \$48 Month/36 months**

Platinum Exchange Warranty Program
 Additional Year Add \$ 139

*The Elite 12/600, Elite 1212, and the Elite XL 608LC support one additional paper feeder. The Elite XL 20/600, Elite XL 20/800, and the Elite XL 20/1200 support two additional trays. **Leasing provided by independent leasing companies to qualified customers. Lease payments based on 36-month term. Lease terms subject to change without notice or obligation.

GCC Technologies is a registered trademark of GCC Technologies, Inc. Elite 12/600, Elite 1212, Elite XL 608 LC, Elite XL 20/600, Elite XL 20/800 and the Elite XL 20/1200 are trademarks of GCC Technologies, Inc. All other trademarks or registered trademarks are trademarks of their respective companies.

To order call 1-800-422-7777, or visit our web site, www.gcctech.com

AnthroCarts!®

Built like tanks with a Lifetime Warranty!



Educational Discounts • Dozens of Shapes and Sizes
Over 75 Accessories • Tough as Nails • Order Direct!

Call for a free Catalog:

800-325-3841

6:00 AM to 6:00 PM PST, M-F

ANTHRO®

Anthro Corporation®
Technology Furniture®
Tualatin, OR 97062
Fax: 800-325-0045
Japan: 03 (Tokyo)-3947-2735
www.anthro.com



Since 1984. Prices from \$299. GSA contract. Available for OEM applications.

Macworld

EDITOR IN CHIEF

Andrew Gore

EXECUTIVE ASSISTANT

Cynthia A. McDonald

EDITORIAL

EDITOR

Michael Penwarden

SENIOR EDITOR/NEWS AND REVIEWS

Stephen Beale

SENIOR EDITOR/DEPARTMENTS

Nancy Peterson

SENIOR EDITOR/FEATURES

Jason Snell

SENIOR ASSOCIATE EDITORS

Allyson Bates,

Linda Comer,

Scholle Sawyer

ASSOCIATE EDITOR

Brooke C. Wheeler

ASSISTANT EDITOR

Michael Gowan

CONTRIBUTING EDITORS

David Biedny, Henry Bortman, Christopher Breen, Bruce Fraser, Ted Landau, Deke McClelland, Rik Myslewski, David Pogue, Lon Poole, Franklin N. Tessler

INTERNATIONAL EDITORS

Steven Noble, Australia; Bernard Le Du, France; Andreas Borchert, Germany; Enrico Lotti, Italy; Yoshio Moriya, Japan; Tomasz Bitner, Poland; Daniel de Blas, Spain; Lennart Håkansson, Sweden; Fred Jame, Taiwan; Bahattin Apak, Turkey; Simon Jary, United Kingdom

LAB

LAB DIRECTOR

Jeff Pittelkau

ASSOCIATE LAB DIRECTOR

Kristina De Nike

SENIOR LAB ANALYSTS

Jeffy K. Milstead,

Kevin Mitchell

ASSOCIATE LAB ANALYST

Gil Loyola

INVENTORY COORDINATOR

Ulyssis Bravo

COPY EDIT

MANAGING EDITOR

Claire H. Breen

COPY CHIEF

Paul-Michael King

SENIOR COPY EDITORS

Elissa Rabellino,

Jon Zobenica

ART AND DESIGN

DESIGN DIRECTOR

Eleanor Leishman

ART DIRECTOR

Sylvia Chevrier

ASSOCIATE DESIGNERS

Martha Katt,

Michael Rattary

DESIGN ASSOCIATES

Jackie Goodman,

Jonathan Woolson

ONLINE

PUBLISHER

Jeff Julian

DIRECTOR OF CONTENT

Matthew Rothenberg

SENIOR ONLINE EDITOR

Philip W. Dyer

CONTENT ENGINEER

Jeff Cheney

ASSISTANT CONTENT ENGINEER

Jessica Graves

DIRECTOR, BUSINESS DEVELOPMENT FOR ONLINE

Nicholas Harvey

ACCOUNT MANAGER

Diana Berry

America Demands Digital Color For Everyone



Fiery Driven is a trademark of Electronics for Imaging, Inc. © 1998 Ricoh Corporation

Affordable Digital Color. For Every Company. Every Department.

From \$11,500

Aficio Color™

A complete range
of digital solutions

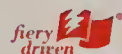

Brilliant digital color every office can afford. Spectacular presentations every time. Experience the productivity of smart digital features for thousands less. Ask for a demo of the most affordable, fully featured, fully connectable digital color systems in the U.S. For more details, call 800 63 RICOH. Online www.ricoh-usa.com



RICOH®
Image Communication

Choose 4 at www.macworld.com/getinfo

Schedule Today. Succeed Tomorrow.



The Right Choice for Easy Project Scheduling.

Stay organized and in control as your project plans come to life in rich, presentation-quality schedules. Whether you need to schedule a day's worth of activities or plan a project into the Year 2000 or beyond, FastTrack Schedule 6.0 makes it easy to organize tasks, meet deadlines, and achieve project goals.

FastTrack Schedule reduces project planning to a simple point-and-click process. So regardless of your skill level, you'll create professional schedules quickly and easily. FastTrack Schedule's colorful timelines, histograms, and line graphs clearly illustrate and communicate project objectives, assignments, and statuses—keeping team members and clients informed and up-to-date. FastTrack Schedule is also available for Windows® 95/98/2000 and Windows NT® 4.0, so everyone in your office can stay on schedule.

FastTrack Schedule™

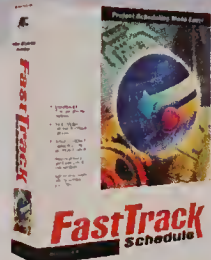

UPGRADE NOW to the NEW Version 6.0

For information or to order, call
(800) 450-1982

Download a **FREE DEMO** today!
www.aecsoft.com



Macworld, Dec. 97 MacWEEK, Oct. 97 Macworld, UK, Dec. 97 MacUser, UK, Nov. 97

Choose 203 at www.macworld.com/getinfo

Macworld

| | |
|-----------------------------|------------------|
| PRESIDENT AND CEO | Colin Crawford |
| ASSISTANT TO THE CEO | Sharon Sanderson |
| CHIEF FINANCIAL OFFICER | Stephen Daniels |
| BUSINESS MANAGER | Eos de Feminis |
| ACCOUNTING COORDINATOR | Ronda Bittner |
| IT ASSISTANT | Christian Semmel |
| DIRECTOR OF HUMAN RESOURCES | Sue Murphy |
| HUMAN RESOURCES COORDINATOR | Ada Yim |

DISPLAY ADVERTISING SALES

| | |
|------------------------------------|-------------------------------------|
| VICE PRESIDENT, SALES, & PUBLISHER | Matt Sweeney |
| ASSOCIATE PUBLISHER | Steve Plevin (415/243-3509) |
| SALES COORDINATOR | Karla Kyrias (415/278-8542) |
| SALES ASSISTANT | Bryan Farnsworth (415/243-3577) |
| NATIONAL ACCOUNTS MANAGER | Jessica Ross (415/243-3583) |
| NATIONAL ACCOUNTS MANAGER | Sara Culley (970/327-4499) |
| ACCOUNT EXECUTIVE | Margaret Level Green (415/243-3582) |
| EASTERN ADVERTISING DIRECTOR | Cynthia Ramsey (973/243-1197) |
| NATIONAL ACCOUNTS MANAGER | Paul Bonarrigo (508/533-4020) |
| ACCOUNT EXECUTIVE | Jo Zottarelli (516/277-4134) |
| SHOPPER ACCOUNT MANAGER | Niki Stranz (415/243-3664) |
| SHOPPER ACCOUNT MANAGER | Carol Johnstone (415/243-3691) |

RESEARCH

| | |
|-------------------------|-----------------|
| SENIOR RESEARCH ANALYST | Phillip Hibbert |
|-------------------------|-----------------|

MARKETING

| | |
|-------------------------------|---------------|
| VICE PRESIDENT, MARKETING | Vickie Welch |
| MARKETING MANAGER | Francesca Koe |
| TRADE SHOW/EVENTS COORDINATOR | Nancy Galanty |

MACWORLD GLOBAL PRODUCT SUPPORT CENTER

| | |
|-------------|---------------------------------|
| COORDINATOR | Sharon Sanderson (415/243-3640) |
|-------------|---------------------------------|

PRODUCTION

| | |
|----------------------------------|------------------|
| VICE PRESIDENT OF MANUFACTURING | Anne Foley |
| PRODUCTION DIRECTOR | Cynthia Neustadt |
| MANUFACTURING TECHNICAL DIRECTOR | Clayton Haberman |
| DIGITAL AD COORDINATOR | Mac Scott |
| AD SALES COORDINATOR | Rick Sandoval |

Macworld is a publication of Mac Publishing, L.L.C. Macworld is an independent journal not affiliated with Apple Computer, Inc. Macworld, MacUser, MacWeek, Macworld Interactive, Macworld Shopper, MW, MW Lab, MW Shopper, The Desktop Critic, Expert Graphics, Quick Tips, Star Ratings, Buyers' Tools, Streetwise Shopper, and Conspicuous Consumer are registered trademarks of Mac Publishing, L.L.C. Apple, the Apple logo, Mac, and Macintosh are registered trademarks, and MacLetter and PowerBook are trademarks, of Apple Computer, Inc. Printed in the United States of America. Copyright © 1999 Mac Publishing, L.L.C. All rights reserved.

By the time other graphics accelerators have finished showing you her...



IXMICRO™ has introduced you to her 6'5", 265 lb. boyfriend.

When you have a faster graphics accelerator, you can save yourself a lot of time and trouble. **ix3D™** — the #1 selling graphics board for the Mac. These 128-bit boards are the ultimate in resolution and pure performance, from the makers of TwinTurbo.® And unlike her, ix3D is available. **Now.**

Ultimate Rez — for graphic experts demanding high performance at extreme resolutions - ideal for 19- to 24-inch monitors

Pro Rez — for graphics professionals operating at moderately high resolutions - ideal for 17- to 19-inch monitors

Mac Rocket — for home and small office and budget-minded graphics professionals - ideal for 14- to 17-inch monitors

Road Rocket — Extended desktop for users of the new Macintosh Powerbook G3 Series



AVAILABLE AT

COMP USA
THE COMPUTER SUPERSTORE

MacMall

MacWAREHOUSE

The Mac Zone

MICRO CENTER
THE COMPUTER DEPARTMENT STORE

1.888.467.8282

Choose 53 at www.macworld.com/getinfo



IXMICRO™

WWW.IXMICRO.COM

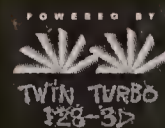

©1998 IXMICRO. TwinTurbo is a registered trademark of IXMICRO. All rights reserved. All other product and company names are property of their respective owners.

furniture for the way you do business.
as individual as you are.



1.800.688.2446 x622

www.agiodesigns.com/mw

free catalog

AGIO DESIGNS™

Choose 265 at www.macworld.com/getinfo

Macworld

HOW TO CONTACT MACWORLD

Subscription Services

Phone 303/665-8930, United States only
303/604-7445, outside the United States
U.S. Mail Macworld Subscription Services
P.O. Box 54529, Boulder, CO 80322-4529
World Wide Web www.zdnet.com/zdsubs/macworld/service

Subscription Rates

The one-year (12-issue) subscription rate is \$34.97 in the United States and \$54.97 in Canada and Mexico; for all other countries, send either \$54.97 for surface mail or \$104.97 for air mail. The two-year U.S. rate is \$59.97, and the three-year rate is \$79.97. Checks must be made payable in U.S. currency to Macworld. Please allow 6 to 8 weeks to receive your first issue.

Back Issues of Macworld

Back issues (subject to availability) are \$8 per issue for U.S. delivery (\$12 outside the United States); prepayment in U.S. currency to Macworld is required. Send check or money order to Back Issues Department, Ziff-Davis Inc., P.O. Box 53131, Boulder, CO 80322-3131.

Reprints and Permissions

You must have permission before reproducing any material from *Macworld*. Write to *Macworld*, Reprints and Permissions, 301 Howard St., 16th Fl., San Francisco, CA 94105; include a phone number. To order reprints of your company's editorial coverage, call Reprint Services at 800/217-7874 or 651/582-3800; fax 651/633-1862.

Newsstand CD-ROM

Readers can obtain newsstand CD-ROMs by mailing a check for \$3.95 (includes shipping and handling) for each CD to Macworld SCS, One Park Avenue, 5th floor, New York, NY 10016. Please state CD title and issue. Make sure to include shipping name and mailing address. Subscribers interested in receiving CD-ROMs monthly should call 303/665-8930 for more information.

Mailing Lists

We periodically make lists of our customers available to mailers of goods and services that may interest you. If you do not wish to receive such mailings, please write to us and include a copy of your mailing label.

Macworld on Microfilm

Macworld is available on microfilm and microfiche from UMI, 300 N. Zeeb Rd., Ann Arbor, MI 48106-1346; 313/761-4700.

Macworld Editorial

The editors of *Macworld* welcome your tips, compliments, or complaints. Stories and product reviews from past issues can be located at www.macworld.com. We are unfortunately unable to look up stories from past issues; recommend products; or diagnose your Macintosh problems by phone, e-mail, or fax. Contact Apple toll-free at 800/538-9696, ext. 500, for information on user groups in your area.

Our offices are located at 301 Howard St., 16th Fl., San Francisco, CA 94105; 415/243-0505, fax 415/442-0766.

LETTERS TO THE EDITOR Direct all comments and suggestions regarding any aspect of the magazine to letters@macworld.com. Due to the high volume of mail received, we can't respond personally to each letter. We reserve the right to edit all submissions. All letters published in *Macworld* or *Macworld Online* become the property of *Macworld*.

QUICK TIPS Send your questions or tips on how to use Mac computers, peripherals, or software to *Macworld Quick Tips*, 301 Howard St., 16th Fl., San Francisco, CA 94105; fax 415/442-0766; e-mail quicktips@macworld.com. Please include your name, address, and telephone number.



SuperDisk
Zip 100
Hard Drive
Charger
Adapter
Battery

VST TECHNOLOGIES Incorporated

Accessories for your PowerBook G3 Series
www.vsttech.com

Omega, the Omega logo & Zip are trademarks of Omega Corporation. All other trademarks are property of their respective holders. Omega patents protected by patent applications pending in the US and other countries. PowerBook is a registered trademark of Apple Computer, Inc. SuperDisk is a trademark of Imation Corp.

Choose 73 at www.macworld.com/getinfo

PC Games to the MAX!

INCUBATION
TIME IS RUNNING OUT



BATTLE ZONE™
The Ultimate Game Card



Play the hottest
best selling PC games!

Battle Zone
Bladerunner
Curse of Monky Island
Deer Hunter
Descent Freespace
F-15
Fallout 2
Final Fantasy VII
Flight Simulator '98
Forsaken
Grand Theft Auto
Hexen II
Incubation
Interstate '76
Jedi Knight
Outlaws
Outwars
Police Quest S.W.A.T. 2
Prophecy
Quake II
Rocky Mountain Trophy Hunter
Tomb Raider II

And More Windows®
Games!

Activision's Civilization
Age of Empires
Age of Sail
Alpha Centauri
Anacronox
Apache Havoc
Asheron's Call
Asteroids 3D
Baldur's Gate
Betrayal at Anatra
Birth of the Federation
Blackstone Chronicles
Blood II
Cabela's Big Game Hunter
Caesar III
Chaos Gate
Close Combat 2
Combat Flight Simulator
Cyberstrike II
Dark Reign
Death Rally
Descent III
Diablo II
Diakatana
Dominant Species
Draken
Duke Nukem
Dungeon Keeper II
East Front
Enemy Stations
Everquest

And Many
More...

Available At:

MICRO CENTER

www.microcenter.com

Orange Micro
Inc.

"18 Years Of Innovation and Excellence"

(714) 779-2772

www.orangemicro.com

The Ultimate Game Card for The Macintosh!

The new PCfx!™ PC game card from Orange Micro was specially designed to run the high-end 3D PC games on the Mac!

Includes:
32MB, nVidia RIVA 128™ 3D graphics accelerator, 200 MHz Pentium Compatible Processor, Direct Sound Compatible, PC Game Sampler CD ROM & Windows® 98!

© Orange Micro, Inc. 1998. PCfx!™ is a trademark of Orange Micro, Inc. FORSAKEN™ & © 1997 Acclaim Entertainment, Inc. All rights reserved. Incubation: Time is Running Out is a trademark of Blue Byte Software, Inc. Battle Zone™ is a trademark of Activision, Inc. S.W.A.T. 2 is a registered trademark of Sierra Online, Inc.

Choose 60 at www.macworld.com/getinfo



ACCURATE.

Get a perfect reflection of your idea with the LaCie electron19blue.™ Its flat screen CRT technology displays an image which is shielded from outside light influence by



LaCie's color-enhancing blue hood. All on a vertically and horizontally flat screen that eliminates distortion. So you can be sure the idea you see is the idea you get.

LACIE

Made for ideas.

YOU'VE GOT TO SEE IT IN **EPSON** COLOR.



Our 1440 dpi lets you see them. How many are you able to find? Two? Three? Thanks to an EPSON Stylus® Color printer, these amazing dancers are now appearing right before your eyes. Of course, with other printers you might see how well they blend in. But with ours, you see how much they stand out. All four of them.

PRESENTING THE WORLD'S FIRST 1440 DPI INK JET PRINTERS.

Only Epson® ink jet printers have the PerfectPicture™ Imaging System for:
1440 x 720 dpi • Micro Piezo™ technology for a cleaner, more consistent dot • Quick-drying inks • Up to 9 PPM black on the Stylus Color 850 • PC and Mac compatibility • Optional internal ethernet. For more information, call 1-800-GO-EPSON (ask for Oper. 3010) or visit us at www.epson.com.



Epson Stylus Color 850. Our fastest business printer. \$349
Epson Stylus Color 1520. Our wide-format business printer. \$499

Maximum print speed is 9 PPM in economy mode. Additional processing time will vary depending on system configuration, software application and page complexity. Prices may vary. Epson and EPSON Stylus are registered trademarks of Seiko Epson Corp. PerfectPicture and Micro Piezo are trademarks of Epson America, Inc. ©1998 Epson America, Inc.

Choose 61 of www.mocworld.com/getinfo

Letters

To iMac or Not to iMac?

I PRACTICALLY HAD MY HAND ON the phone to order an iMac when the October issue of *Macworld* arrived with its “iMac Reality Check.” That issue alone was worth the price of a year’s subscription. Let me get this straight: If I replace my Power Computing PowerCenter 150 with an iMac, I won’t be able to use my Iomega Zip, my Jaz, my scanner, or either of my printers? And although hardware adapters may be in the pipeline, interface software is far behind. This is all one more reason why my next PC may be a PC.

BILL HARRISON
Huntsville, Alabama

I HAVE ONE THING TO SAY TO everyone who has lamented the iMac’s lack of a floppy drive and serial/SCSI ports: buy yourself a Power Mac. The iMac targets an audience with simple needs and few peripherals, not to mention a tight budget. If you want to use your Jaz drive, 3Com PalmPilot cradle, and 3.5-inch floppies, stick with the core of the hardware line and give yourself credit for being a power user. The iMac’s “shortcomings” are calculated omissions designed to suit the needs of basic and new users, not the death knell for Macintosh connectivity. Get over it! Apple is still making CPUs that sport all the bells and whistles.

N. ANDY HILAL
Oakland, California

I DISAGREE WITH YOUR STATEMENT that the iMac can hold only 128MB of RAM. Several companies currently manufacture and sell 128MB RAM DIMMs for the iMac, allowing for a total



of 256MB. I know this because I just installed extra RAM in my iMac.

KEITH THRASH
Jackson, Mississippi

What we said was true when we went to press. And as Macworld goes to press again, Apple’s official position is still that the iMac has a 128MB RAM limit. Obviously, vendors are selling RAM upgrades that go beyond this limit, and reports are that the upgrades work. Apple has not yet certified them, however, nor has Macworld had a chance to test them.—Henry Bortman

Working the Phones

KUDOS TO DAVID POGUE FOR writing about the unsung heroes of the tech-support phone pool (*The Desktop Critic*, October 1998). Although I agreed with many of Pogue’s points, there is one that needs discussion. I read many comments of displeasure when Apple revoked its policy of free tele-

phone tech support, but none provided any reasonable solutions to Apple’s dilemma: the high cost of free tech support versus public disapproval.

Apple cannot presume to offer an “easier to use” and “more stable” platform and yet expect customers to pay for tech support the same as everyone else. Conversely, the public cannot expect the company to bear the cost of fixing problems caused by users’ lack of computer proficiency. Therefore, I propose that Apple have a proficiency test for its customers. Those who score well don’t pay (or pay a reduced rate) for telephone support—the notion being that in such cases, the problem will likely turn out to have been caused by Apple rather than the user.

YURI HOLOWACKI
Toronto, Ontario, Canada

Hooked on Speed

ANDREW GORE’S “OLD PORTS FOR A New” has an error (*The Vision Thing*, October 1998). The speed of SCSI connections is actually 80 MBps, not 80 Mbps—bytes, not bits. So SCSI isn’t too bad after all. Other than that, I agree with everything said in the column. Look how long the Wintel world is taking to get rid of the ISA bus and all its problems. However, I am disappointed that the latest PowerBooks are still ADB-based—we have six-month-old Wintel portables that have USB.

STEVE LIEBBE
West Lafayette, Indiana

It’s true that we inadvertently transposed bits for bytes in the October 1998 The Vision Thing column on FireWire and USB. However, at 200 Mbps to 400 Mbps, FireWire will still be faster than Apple’s current external continues

CORRECTIONS

- *Hold down the spacebar, not the shift key, during start-up to access the Extensions Manager (Quick Tips, November 1998).*

SCSI, which is running closer to 5 MBps, or 40 Mbps. Only an ultrahigh-speed internal SCSI card paired with high-speed drives will likely perform faster.—Andrew Gore

What About IrDA?

SO MUCH HAS BEEN DISCUSSED about USB, but isn't IrDA worth talking about, too? I understand that it transmits at 4 Mbps, works with many printers, and so on. Wouldn't I be able to connect my Hewlett-Packard LaserJet 6MP (with IrDA) to an iMac without a cable? Who cares about printer-port solutions if IrDA works?

CHRIS BELANGER
Grand Prairie, Alberta, Canada

Have no fear, we're on the case. Macworld Lab plans to test the iMac's infrared capabilities in the near future.—Ed.

Seeing the Light

IN YOUR OCTOBER 1998 FEATURE about digital cameras ("Focus On"), you say that Agfa's ePhoto 1280 and Nikon's CoolPix 900 can automatically sync with freestanding lights in a professional studio but that with the others, your only option is to use the built-in flash. This is not quite accurate. The reason the other cameras appear not to sync automatically is that they provide a preflash for exposure purposes. Most slave flashes sync on the preflash and fail to sync with the flash used for exposure. There are, however, slave flashes on the market that will sync with the main flash, ignoring the preflash.

MICHELLE STEINER
Sunnyvale, California

When Size Matters

IN YOUR INFORMATIVE REVIEW of color printers ("Print Out," October 1998), you apparently made one very important mistake in reporting that the

Epson Stylus Color 1520 prints images up to 17 inches wide. When I tried to print on poster-size paper, I was very surprised to see a great deal of my image cropped off. Upon further investigation of the manual, I found a single line in an appendix stating that no matter what size paper you use, the maximum printable image area is only 13.6 inches. This is like buying a new car that initially seems like a great value only to find out later that the salesperson neglected to mention that the top speed is only 45 mph. What good is a printer that takes 17-inch paper but allows you to print only up to 13.6 inches?

STEPHEN DRAS
Buena Vista, Colorado

You are correct—the Stylus Color 1520's maximum printable area is 13.6 by 21.78 inches. Our apologies.—Ed.

Scanner Highs and Lows

I ENJOYED YOUR COMPARISONS OF digital cameras and color printers ("The Imaging Revolution," October 1998). The articles were well done and very informative. It was very helpful to see a range of prices included and to see how well lower-cost printers fared in the comparison. But the scanner feature was a great disappointment, in that it was limited to expensive units ("Scan In"). Many of us would like to see how lower-priced scanners compare and what quality and features an extra \$1,000 to \$4,000 buys. Please consider doing another lab feature comparing the better low-end equipment with the top-of-the-line scanners.

FRED D. CHERNEY
Scarborough, Ontario, Canada

Dongle Nuisance

THERE IS A "CON" NOT INDICATED by Charles Seiter in his review of Ashlar's Vellum Solids (October 1998): for all versions since the introduction of Vellum 3.X, Ashlar has required a hardware dongle key for using the software. Yet nowhere is that indicated—not even in the manual. I paid for Vellum 3.0 in July and received everything but the dongle key. So far I have not been able to use the software, as I have not received a dongle. I have phoned,

faxed, e-mailed, and sent letters to them. They keep silent.

GABRIEL DORADO
Cordoba, Spain

Proportional Pixels

JIM HEID'S ARTICLE ON THE Digital Video (DV) standard was chock-full of good info—as Heid's articles usually are—but I noticed one small problem ("Set Your Video on FireWire," *Create*, October 1998). One point Heid brought up was to "render with DV in mind," suggesting that to avoid distortion, you should render at 720 by 480 pixels rather than at 640 by 480. Doing this actually produces distortion in the final playback on an NTSC screen, however. The reason is that the decoder in the playback unit compresses the image horizontally to fit it back on the screen; the result is that a rendered circle appears as a tall ellipse.

The problem can be corrected in one of two ways. First, if your rendering program supports it, render at 720 by 480 pixels with a .889-pixel ratio. This tells the renderer to create each frame with the nonsquare pixels that DV expects. On your Mac monitor, the picture looks oblong, but in DV it looks perfect. If your renderer does not support nonsquare pixels, then render at 720 by 540 pixels. This still results in the scaling of your images when you go to DV, but the renderer scales by throwing out information, rather than creating it as is the case when you scale up a 640-by-480 image.

THOMAS BLAHA
Cleveland, Ohio

If your rendering application can handle nonsquare pixels, then you should indeed render at 720 by 480 pixels as I originally suggested. For those with rendering applications that don't support nonsquare pixels, rendering at 720 by 540 is a great idea—you'll get better quality than if you rendered at 640 by 480.—Jim Heid m

Letters should be sent to *Letters*, Macworld, 301 Howard St., 16th Fl., San Francisco, CA 94105; via fax, 415/442-0766; or electronically, to letters@macworld.com. Include a return address and daytime phone number. Due to the high volume of mail received, we can't respond personally to each letter. We reserve the right to edit all letters. All published letters become the property of *Macworld*.

imagine an association totally devoted to adobe photoshop



If you want to learn the hottest techniques, the coolest special effects, and the inside tips that can cut your production time in half, then you've got to join the **National Association of Photoshop Professionals (NAPP)**. NAPP was formed with one goal in mind: to give its members the edge when it comes to Adobe Photoshop. When you join NAPP you'll enjoy advantages only available to members, like:

- **Below mail-order discount prices** on hundreds of Photoshop-related products, Photoshop upgrades, (even hardware) specially arranged just for NAPP members. (Including anything you buy from MacWarehouse). Members also receive significant discounts on **Photoshop seminars, training videos, and books**. Plus special "killer dealz" on specific software and hardware products at the lowest prices offered anywhere.
- You'll learn all the inside secrets with your free subscription to **Photoshop User magazine**—the *only* magazine covering Photoshop exclusively. Each issue teaches you the coolest tips, timesaving shortcuts, how to create those eye-popping effects, how to avoid common mistakes, plus all the latest news and reviews. It's the ultimate "how-to" magazine you'll refer to again and again. There's never been a magazine like it! (Note: Subscriptions to *Photoshop User* are not available to the public, only NAPP members get this invaluable resource mailed to them free!)
- You'll always be "in the know" with exclusive access to the **members-only NAPP Website**. It's the #1 resource on the Web for Photoshop news, plug-in and Action downloads, tips and techniques, online member gallery, job bank, online Photoshop book store, and much more.
- If you've got a Photoshop question, and don't know where to turn, now you'll have a resource to get the answers fast with **NAPP's online 24-hour Photoshop Help Desk**.
- You'll expand your knowledge and network with other Photoshop users from around the world at **NAPP's Annual Conference**. This is where NAPP members come together to get the latest training, share their ideas, solutions, and make important new contacts.
- You'll **enhance your professional image** by using the NAPP logo on your letterhead, business cards, Website, and collateral materials. Plus you get a NAPP membership card, full-color Window sticker, and much more.

Any Photoshop user, at any level, can join NAPP and membership is ideal for graphic designers, photographers, Web designers, service bureaus, print shops, ad agencies, desktop publishers, hobbyists, educators, and anyone who realizes that there's more to learn about Photoshop than there is time to learn. Join the thousands of people who have already made NAPP an important part of their Photoshop success, and we'll rush you your member kit which includes the latest issue of *Photoshop User*.

**A one-year membership is only \$99.
Join Today! Call 800-738-8513**

or join online at www.photoshopuser.com
Corporate, Educational, and International memberships also available.

For more info visit www.photoshopuser.com

Photoshop is a registered trademark of Adobe Systems, Inc. Images courtesy of Rubberball.



NATIONAL ASSOCIATION

NAPP

OF PHOTOSHOP PROFESSIONALS

Choose 94 at www.macworld.com/getinfo

Need it tomorrow?

Order as late as **2:45 a.m. ET** (that's in the morning) and still get delivery next day!

Need it installed?



We'll do it FREE! When you purchase a new Macintosh from us, we will configure it for you at no additional charge.

Visit Our New Website!

www.macconnection.com

- Secure Online Ordering
- Powerful Search Tools



MacConnection®
The Original Macintosh Mail-Order Source!

NASDAQ
TRADED COMPANY
TICKER SYMBOL: PCCC

Apple® and MacConnection®

Apple® Pushing the Limits of Technology.

Apple ignited the personal computer revolution in the 1970s with the Apple II, reinvented the personal computer in the 1980s with the Macintosh, and is re-defining the personal computer for the 1990s with the highly successful G3 series and the new iMac. And the innovation continues with technologies such as QuickTime, which makes video, sound, music, 3D and virtual reality come alive on both Macs and PCs.

Only **\$1299**
104490

Plus Up to **\$235** Worth of Stuff **FREE!**

Turn page for details

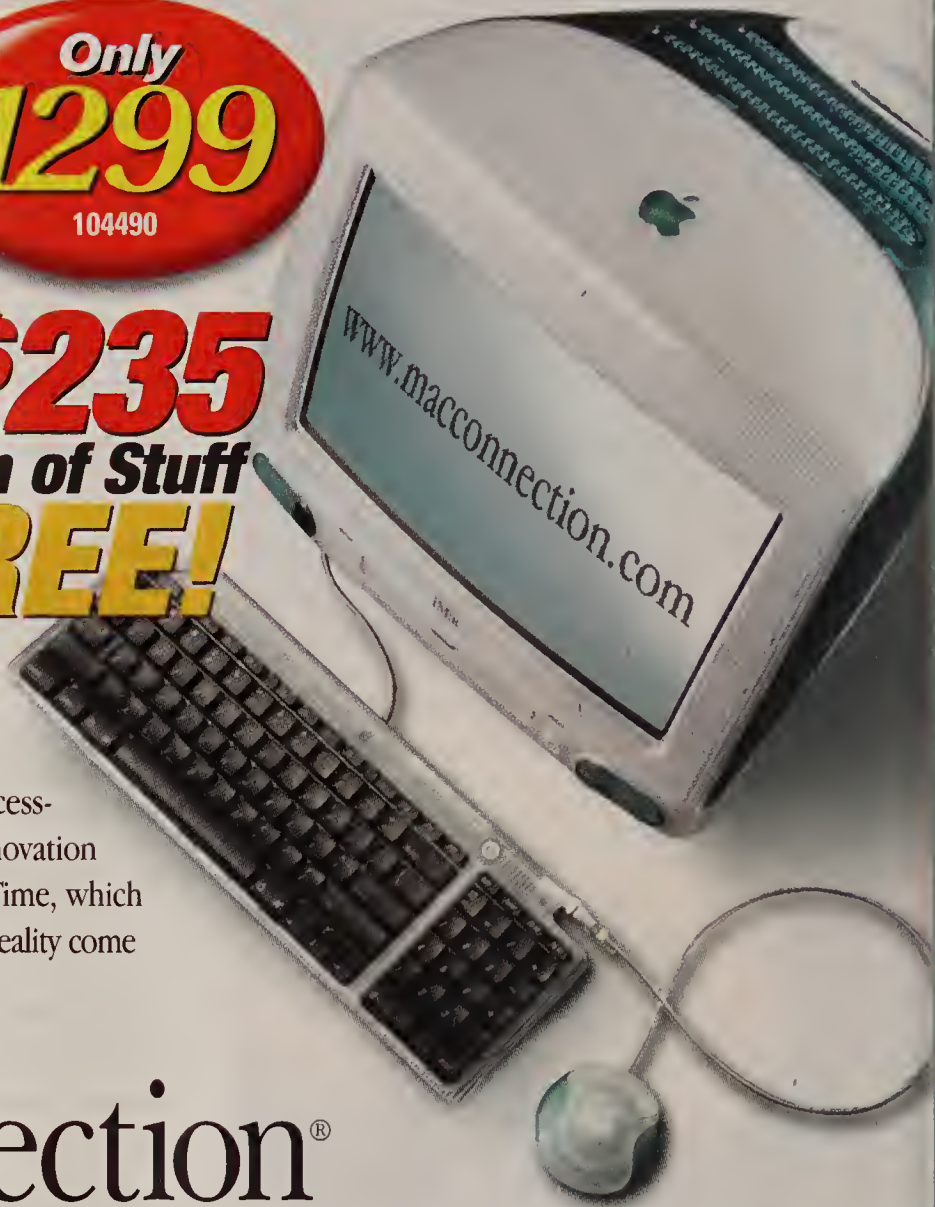

MacConnection®

Setting the Standard then... and Now!

A pioneer in the direct marketing business, MacConnection introduced services that are now standard throughout the industry. Innovations such as overnight delivery, toll-free technical support, One-Minute Mail Order and late-night ordering for next day delivery were unheard of before MacConnection introduced these services. And the innovation continues with our Extended Service Plan, free custom configuration and online services such as Smart Selectors.



TOLL-FREE ORDERING **800-600-9358**

OVER 20,000 HOT PRODUCTS 24 HRS A DAY!

New Ideas for a New Millennium.



iMac "...a clean and exciting break with the past." BUSINESSWEEK 9/7/98

The Supersonic G3

Apple has refreshed its incredibly successful Power Mac G3 series with five new models, including a blazing-fast 333MHz G3 minitower, which promises to be the fastest Power Mac ever. Like all G3 models, it leaves Pentium-based machines in the dust and delivers hot new technologies like backside cache, expanded memory capabilities and support for FireWire, Apple's latest video innovation.

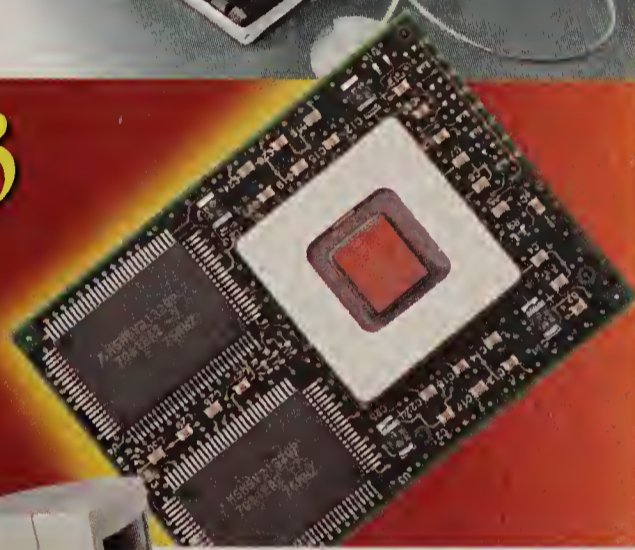

Choose a Winning Team.

When you purchase your new iMac, Power Mac G3 or PowerBook G3 from MacConnection, we'll back it up with the friendly, personalized service and support we pioneered! Plus, we'll custom-configure your new Mac for free and still deliver overnight! So don't wait any longer! Call MacConnection today and order your new Mac!



Power Macintosh® G3

PowerPC 333MHz G3 processor
128MB RAM (Max. 768)
9GB Ultra/Wide SCSI HD
6MB SGRAM
24X CD-ROM
101744

ONLY \$2999

Macintosh® PowerBook G3

Starting At \$2199

PowerPC 300MHz G3 processor
FREE VST 100MB Zip drive (14.1" only)
64MB RAM (Max. 192)
8GB HD
DVD-Video
10BT/56K Modem
14.1" TFT Active Matrix Display
104252 \$4999



Mac OS 8.5 The Most Powerful Mac Yet!

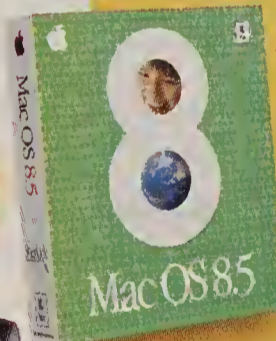

New Sherlock Find technology, superior Internet experience, native AppleScript, and the fastest networking available make Mac OS 8.5 the best Mac OS yet! Call and order today!



CALL or CLICK™

www.macconnection.com

199MW

**24 HOURS
7 DAYS
A WEEK!**

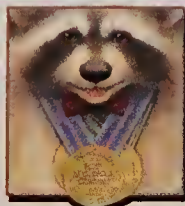

MacConnection®

The Original Macintosh Mail-Order Source - Since 1984!

Guaranteed Low Prices!

Great products from Apple, Adobe, Newer Technology, Microsoft, Iomega and more!

Need Info?



On cables, RAM, or connecting a modem or scanner or digital camera to your Mac?

We offer toll-free technical support on everything we sell.

iMac



Say Hello to iMac.

The Mac Everyone Wants!

Only **\$1299**
104490

It may look cool, but it sure is hot! The iMac is the most anticipated computer of the 1990s, and it's flying off our shelves! That's because it delivers everything you need for stress-free computing, including blazing 233MHz G3 speeds, all-in-one convenience and easy Internet access, all at an incredibly low price! Find out for yourself what all the buzz is about. Order your iMac today!



- 233MHz G3
- 15" Display (13.8" viewable)
- 64 or 96MB SDRAM
- 4GB IDE Hard Drive
- 24X CD-ROM
- Built-in 56Kbps Modem and 10/100BT Ethernet
- 6MB VRAM ATI Rage Pro
- 512K Backside Cache
- Two 12Mbps USB Ports
- Built-in SRS Stereo Speakers

Ships with Mac OS 8.5!

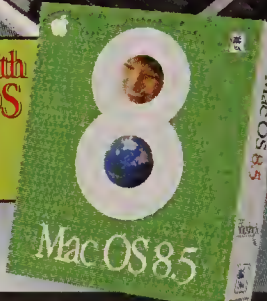

Worth of Stuff **FREE!**

SAVE \$150! iMac Home Bundle

INCLUDES: Additional 32MB SDRAM (64MB total), CyberPatrol*, Compton's Encyclopedia 98* & FREE Installation!
\$1299 104490

SAVE \$175! iMac Power Bundle

INCLUDES: Additional 64MB SDRAM (96MB total), CyberPatrol*, Compton's Encyclopedia 98* & FREE Installation!
\$1328⁹⁵ 105097

SAVE \$235! iMac Deluxe Bundle

INCLUDES: Additional 64MB SDRAM (96MB total), CyberPatrol*, Compton's Encyclopedia 98*, 120MB SuperDisk Drive, 5-pk LS-120 diskettes & FREE Installation!
\$1478⁹⁵ 105045

*While supplies last

ACCESSORIES

- Apple**
- 56129 PowerBook G3 AC Adapters\$79
 - 56131 Lithium-Ion Rechargeable Battery229
 - 56133 G3 Floppy Disk Drive Expansion Bay Module...109
 - 35931 1400 NiMH Battery135.95
 - 38465 3400 Lithium Ion Battery199.95
 - 16033 PowerBook 500 Battery125.95
 - 35928 PowerBook AC Adapter 1400, 2400, 3400...49.95
 - 35929 PowerBook 1400 Video Out.....149.95

CARRYING CASES

- Targus**
- 7369 Targus NotePac (Black)\$39.95
 - 31084 Targus NotePac Plus59.95
 - 1305 Universal Notebook Case (Black)69.95
 - 29851 Universal Deluxe Carrying Case129.95
 - 56460 Air Universal w/FREE Fanny Pack99.95
 - 41412 Digital Camera Case-Nylon.....39.95
 - 48238 PDA/Handheld Leather Wallet39.95
 - 48239 PDA/Handheld Leather Double Wallet59.95
 - 48243 Full-Size Leather Portfolio.....99.95
- Kensington**
- 10410 Kensington Deluxe Computer Carrying Case \$54.95
 - 7060 MicroSaver Security Cable System.....39.95
 - 48823 Sky Runner Nylon Carrying Case69.95
 - 35526 Saddle Bag Black w/Black Trim89.95
 - 33443 Saddle Bag Black w/Brown Trim89.95

- 9585 Executive Computer Case99.95

DATA STORAGE

- Iomega**
- 102640 100MB Zip Drive - SCSI External.....\$119.95
 - 44384 Zip Disk 10-Pack Gig O Color99.95
 - 102879 Jaz 2GB External Drive349.95
 - 47082 Jaz 2GB 3-Disk Pack.....299.95
 - 44705 ZipPlus169.95
 - 46089 Zip Drive SCSI Insider w/FREE Zip Zoom...119.95
- LaCie**
- 59543 9.1GB HD Internal\$529
 - 59542 9.1GB HD External629
 - 103603 36X External CD-ROM Drive159
 - 59402 4.0GB Apple External Hard Drive419
 - 58081 External 2x8 Recordable Drive349
- Quantum**
- 50871 2.1GB Fireball SE Ultra SCSI Int HD\$219
 - 50869 4.3GB Fireball SE Ultra SCSI Int HD289
 - 50867 8.4GB Fireball SE Ultra SCSI Int HD489

- VST**
- 57228 Internal Zip Drive for PowerBook G3\$239.95
 - 38024 Internal Zip Drive for 3400/5300/190.....229.95

DIGITAL CAMERAS

- AGFA**
- 36253 ePhoto 307.....\$249
 - 47140 ePhoto 1280.....599

- 100139 ePhoto 1680899

Canon

- A. ZR Ultra-Compact MiniDV Camcorder Shoot both video & stills! 57435 Only \$995
- B. Canon CD-200 Direct Digital Printer Print 4"x6" pictures instantly from your camera! 57728 Only \$499



Canon USA

- 101674 Vistura MiniDV Camcorder.....1495
- 57434 Optura MiniDV Camcorder1795

Connectix

- 26954 Color QuickCam\$189.95

Kodak

- 52680 DC200 Digital Camera (adapter reqd.)...\$399
- 56897 DC220 Zoom Digital Camera699
- 56896 DC260 Zoom Digital Camera.....899

Nikon

- 55074 CoolPix 600\$379
- 104285 CoolPix 900S749

Olympus

- 46391 D-320L Digital Camera.....\$399
- 55672 D-340L Digital Camera499
- 104248 D-400 Zoom.....799

- 104249 D-620-L1199
- 47234 D-600L Digital Camera899

Sony

- 103305 **NEW!** Mavica FD81 Digital Camera\$799

INPUT DEVICES

Kensington

- 25696 Mouse in a Box for Mac\$39.95
- 39536 Kensington Orbit for Mac69.95
- 25697 Turbo Mouse99.95

Macally

- 102334 USB iHub 4 Port Hub for iMac.....\$49.95
- 102331 USB iBall 2 Button Trackball for iMac47.95
- 102329 USB iKey 105 Extended Keyboard for iMac 49.95

MDS

- 21456 2-Button Ergonomic Mouse\$19.95
- 21459 2-Button Trackball32.95
- 22799 105-Key Soft-Touch Keyboard.....39.95
- 40380 2-Button Joystick34.95
- 40381 Bat Wing GamePad26.95

HANDHELD DEVICES

3Com

- 54104 Palm III w/Travel Pack (\$135 Value)\$349.95
- 39153 PalmPilot Pro.....229.95
- 39154 PalmPilot Modem129.95
- 105049 **NEW!** PalmPilot Mac Pack14.95
- 33944 PalmPilot Slim Leather Carrying Case.....19.95

Every iMac comes loaded with FREE software, including:

- Mac OS 8.5
- AppleWorks 5
- Quicken Deluxe 98
- Kai's Photo Soap
- Microsoft Internet Explorer
- MS Outlook Express 4.01
- FAXstf 5.0
- MDK from Interplay
- Pangea Software's Nanosaur
- Williams-Sonoma Guide to Good Cooking
- Earthlink's Total Access 2.01



Take A Closer Look...

The iMac has two USB ports, which replace SCSI, ADB and traditional Mac serial ports with an inexpensive, speedy alternative. You can connect up to 127 devices to your iMac, and plug and unplug devices without restarting!

With the iMac's 32MB of RAM (expandable to 256MB), you'll have plenty of memory to run all your favorite applications and games. Plus, a 4GB EIDE hard drive and 24X ATAPI CD-ROM drive are standard equipment.

The iMac delivers premium sound through its built-in SRS stereo speakers. Music lovers also have the option of attaching external speakers. Two headphone jacks makes gaming a blast for players (but quiet for you).

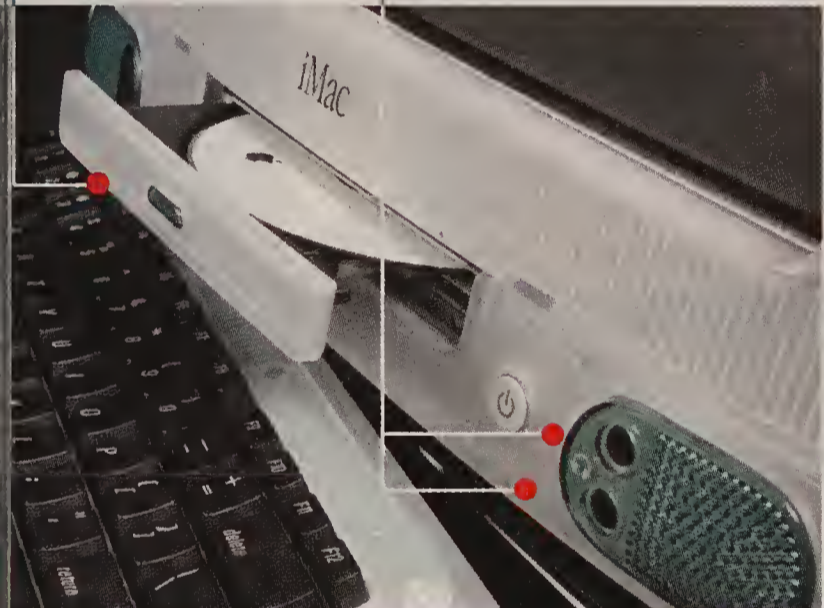

ALL NEW! USB Products for iMac

USB Macally Peripherals for iMac

macally
iBall 2-Button Trackball
 ONLY \$47.95 102331

iMouse Single-Button Mouse
 102332 iMouse Single-Button Mouse \$24.95
 102329 iKey 105 Extended Keyboard .49.95

USB iomega 100MB Zip Drive

iomega
 ONLY \$149.95 104268

USB Stylus Color 740

EPSON
 ONLY \$279 **iMac ready!**
 • 1440 x 720dpi
 • Photo-quality Color
 • Laser Sharp Black Text
 100452

USB HP DeskJet 697C w/iMac Kit

HP HEWLETT PACKARD Expanding Possibilities
 ONLY \$249 102727
 • iMac connectivity kit
 • 5ppm color
 • ColorSync 2.0 support

GT Interactive Unreal

Eye-popping 3-D Action!
 ONLY \$44.95 102261

NEW! FireWorks

macromedia
 ONLY \$285.95 55808

Adobe PageMill 3.0

Adobe
 ONLY \$89.95 102963

Ages of Myst Includes Myst & Riven!

MINDSCAPE
 ONLY \$54.95 103997

Norton Utilities

SYMANTEC
 ONLY \$49.95* 101293
 *After \$50 upgrade rebate.

Order Weekends, Get It Monday!



Order as late as 2:45 a.m. ET (that's in the morning) and still get delivery next day!



We'll Build It FREE!

We will configure your Mac the way YOU want it... at no additional charge!

FREE Catalog!

Call or visit our website to request our catalog.



| MEMORY | |
|--|---------|
| 100621 iMac 32MB | \$69.95 |
| 100626 iMac 64MB | 139.95 |
| 100627 iMac 128MB | 279.95 |
| 57248 PowerBook G3 32MB (Wallstreet) | 69.95 |
| 57249 PowerBook G3 64MB (Wallstreet) | 139.95 |
| 57250 PowerBook G3 128MB (Wallstreet) | 279.95 |
| 38743 PowerBook G3 32MB | 99.95 |
| 49272 PowerBook G3 64MB | 149.95 |
| 49167 PowerBook G3 128MB | 299.95 |
| 43593 PowerBook 2400 Series 32MB | 99.95 |
| 43594 PowerBook 2400 Series 64MB | 159.95 |
| 38743 PowerBook 3400 Series 32MB | 99.95 |
| 38744 PowerBook 3400 Series 64MB | 159.95 |
| 38746 PowerBook 3400 Series 128MB | 299.95 |
| 24152 PowerBook 5300 Series 32MB | 129.95 |
| 27819 PowerBook 5300 Series 48MB | 179.95 |
| 27820 PowerBook 5300 Series 56MB | 229.95 |
| 49125 Power Mac G3 32MB | 39.95 |
| 49127 Power Mac G3 64MB | 89.95 |
| 49130 Power Mac G3 128MB | 179.95 |
| 23000 Power Mac 7200,7300,7500,7600 32MB | 49.95 |
| 23001 Power Mac 7200,7300,7500,7600 64MB | 79.95 |
| 23000 Power Mac 8500,8600,9500,9600 32MB | 49.95 |
| 23001 Power Mac 8500,8600,9500,9600 64MB | 79.95 |
| MODEMS | |
| Best Data | |
| 58886 56K External Modem | \$69.95 |
| 56473 56K PCMCIA Card Modem | 69.95* |
| *After \$20 mfr's mail-in rebate | |

| Diamond Multimedia | |
|--|----------|
| 53088 Supra Express 56K V.90 Ext. Modem | \$99.95* |
| *After \$20 mfr's mail-in rebate | |
| Global Village | |
| 54275 56K TelePort Ext. V.90 | \$139.95 |
| 100961 56K TelePort Ext. V.90 with G3 purchase | 99.95 |
| Simple Technology | |
| 49812 56K Communicator PC Card Modem | \$119.95 |
| Zoom | |
| 30842 33.6 External Faxmodem V34X Plus | \$59.95* |
| 53670 56K Dualmode External Faxmodem | 104.99 |
| *After mfr's mail-in rebate | |

| MONITORS | |
|--------------------------------------|-------|
| Hitachi | |
| 43310 MC6315 RasterOps 17" Monitor | \$399 |
| 43348 MC7515 RasterOps 19" Monitor | 689 |
| 33148 MC801HR RasterOps 21" Monitor | 1399 |
| Mitsubishi | |
| 51575 Diamond Plus 70 17" Monitor | \$469 |
| 36276 Diamond Pro 91TXM 21" Monitor | 1049 |
| 101099 Diamond Pro 1000e 21" Monitor | 1299 |
| NEC | |
| 43813 A700 17" Monitor | \$399 |
| 57869 E900 19" Monitor | 679 |
| 103710 E1100 21" Monitor | 999 |
| Sony | |
| 48756 CPD-200GS 17" Monitor | \$499 |

| | |
|-----------------------------|------|
| 48749 GDM-400PS 19" Monitor | 849 |
| 48750 GDM-500PS 21" Monitor | 1249 |

MITSUBISHI
 Diamond Scan 70
 • .28mm dot pitch
 • 1280 x 1024 @ 65Hz
 • 16" viewable
 100822 \$399

| ViewSonic | |
|-----------------------------------|-------|
| 39386 Optiquest Q53 15" Monitor | \$179 |
| 39387 Optiquest Q71 17" Monitor | 259 |
| 43960 Optiquest V9S 19" Monitor | 539 |
| 54160 Optiquest V11ST 21" Monitor | 1049 |

ORDER ONLINE!
CALL or CLICK™
24 HOURS 7 DAYS A WEEK!
TOLL FREE ORDERING

www.macconnection.com 199MW
MacConnection®
 The Original Macintosh Mail-Order Source—Since 1984!
800-600-9358
 MACWORLD January 1999 23

Millions of Satisfied Customers!

Since 1984 MacConnection has been providing award-winning service and support for Macintosh users. Over on the PC side, PC Connection has done the same for PC users. Named the Best Mail-Order

Company an unprecedented seven times by PC World Magazine, and honored as one of the 100 Most Influential Companies by PC Magazine. So,

whichever platform you're using you can be sure to find a Connection you can trust.



More Style,
More Power!

- Up to **300MHz** G3 processor
- Up to **8GB** Hard Drive
- Up to **14.1"** TFT Display
- Up to **7 Hours** Battery Life On average with dual battery operation (batteries are not swappable)

BusinessWeek Magazine calls the new PowerBook G3 line **"the Lamborghini of laptops."** JULY 1998

— and with good reason! Three new 14.1" models are now available, housing the latest release of the powerful G3 processor, with speeds up to a Pentium-crushing 300MHz. Faster video performance with a new 4MB ATI Rage LT Pro video card built into each 14.1" model, and a DVD Video Drive in the new 300MHz model. Of course all PowerBook G3s have built-in 10BaseT Ethernet and PC Card slots that are CardBus-compliant. Best of all, these stylish, powerful systems can be yours for as little as \$2199, giving new meaning to the term "creative freedom."

New Trackpad

Solid-state Apple trackpad provides precise cursor control; sensing of movement and acceleration is adjustable through a control panel.

Advanced Keyboard

105-key capability
The PowerBook uses a responsive premium scissors technology keyboard, making typing a pleasure.

Includes Additional 32MB RAM

| Item # | Processor/Speed | Backside Cache | Display | RAM Std/Max | VRAM | Hard Drive | Modem | CD-ROM | Weight | S-Video | 10BT | Price |
|--------|-----------------|----------------|---------------|-------------|------|------------|-------|--------|--------|---------|------|-------|
| 105774 | G3/233MHz | 512K | 12.1" TFT | 64/192MB | 2MB | 2GB | 56K | 20X | 7.6 lb | Y | Y | 2199* |
| 104250 | G3/233MHz | 512K | 14.1" TFT XGA | 32/192MB | 4MB | 2GB | 56K | 20X | 7.6 lb | Y | Y | 2799* |
| 104251 | G3/266MHz | 1MB | 14.1" TFT XGA | 64/192MB | 4MB | 4GB | 56K | 20X | 7.6 lb | Y | Y | 3499* |
| 105001 | G3/300MHz | 1MB | 14.1" TFT XGA | 64/192MB | 4MB | 8GB | 56K | 20X | 7.6 lb | Y | Y | 4499* |
| 104252 | G3/300MHz | 1MB | 14.1" TFT XGA | 64/192MB | 4MB | 8GB | 56K | DVD | 7.6 lb | Y | Y | 4999* |

*Floppy Drive not included.

FREE VST Zip Drive
#104250, #104251, #105001, #104252 Only

NETWORKING

Asanté

- 101177 Asanté Talk Adapter\$89.95
- 57993 Asanté Fast 10/100 PCI Adapter49.95
- 57994 Asanté Fast 10/100 PCI Adapter 5 pack...239.95
- 100082 FriendlyNet 10/100 4-Port Switch199.95
- 100083 FriendlyNet 10/100 8-Port Switch.....379.95
- 100084 FriendlyNet 10/100 16-Port Switch1149.95
- 49859 FriendlyNet 8+2 Switch for Small Networks.279.95
- 49858 FriendlyNet 8+2 Switch Plus.....349.95
- 38296 FriendlyNet 10BaseT Hub w/5 RJ45 Ports...42.95
- 38297 FriendlyNet 10BaseT Hub w/8 RJ45 Ports...49.95
- 2772 Asanté 10BaseT Hub 12 Port146.95
- 18906 Asanté 10BaseT Hub 24 Port239.95
- 2583 FriendlyNet 10BaseT Ethernet Adapter.....29.95
- 100694 FriendlyNet 10BaseT Hub w/16 RJ45 Ports...109.95
- 6677 MacCon Nubus 10BaseT/5 Ethernet Adapter.82.95
- 56712 MacCon 10BaseT LC Ethernet Card.....79.95
- 17702 MicroPrint 10BaseT/5 to LocalTalk Converter 149.95

Farallon

- 102103 EtherMac iPrint Adapter\$99.95
- 11607 Transceiver AAUI 10BaseT99.95
- 18193 EtherWave Multi-Printer.....129.95

PRINTERS

Epson

- 55141 Epson Stylus Photo 700.....\$249
- 100452 Epson Stylus Color 740\$279

- 55045 Epson Stylus Color 850349

Hewlett Packard

- 102727 DeskJet 697c with iMac kit\$249
- 104913 Color LaserJet 4500N2499

SCANNERS

AGFA

- 101374 1236 Artline Scanner.....\$249.99

UMAX

- 101653 1220U Scanner (after \$20 mail-in rebate).....\$129

SOFTWARE

Apple

- 103532 **NEW!** Mac OS 8.5\$89
- 102450 Mac OS 8.5 10-user797.95
- 43931 Apple Remote Access 3.0 Personal Server 124.95
- 104773 Web Construction Kit.....94.95

Adobe

- 100493 **NEW!** Adobe Graphics Studio.....\$999.95
- 57851 Adobe Image Ready w/Photoshop89.95
- 57850 Adobe Image Ready179.95
- 54672 Adobe Photoshop 5 Upgrade189.95
- 54673 Adobe Photoshop 5598.95
- 55126 Adobe Premiere 5.0 Upgrade189.95
- 55124 Adobe Premiere 5.0589.95
- 32844 Adobe PageMaker 6.5549.95
- 40860 Adobe PageMill 3.089.95
- 101880 Adobe Illustrator 8 Upgrade.....119.95

- 100197 Adobe Illustrator 8369.95

- 43825 Adobe Acrobat 3.0.1189.95

Aladdin Systems

- 46707 Spring Cleaning 2.0.....\$49.95
- 52083 FlashBack 1.144.95*
- 47006 StuffIt Deluxe 4.578.95
- 44801 Private File.....47.95

Alien Skin Software

- 35801 Eye Candy 3.0 for Photoshop\$119.95
- 48026 Eye Candy for After Effects499.95

Bare Bones Software

- 44284 BBEdit 4.5.1\$99.95

Broderbund

- 45697 Riven: The Sequel to Myst.....\$44.95
- 53302 Journeyman Project 3: Legacy of Time.....29.95
- 46770 Where in Time is Carmen Sandiego?.....33.95
- 57551 Where in the USA is Carmen Sandiego Deluxe CD34.95
- 57552 Where in the World is Carmen Sandiego Deluxe CD34.95
- 52565 Carmen Sandiego Math Detective34.95
- 46771 Carmen Sandiego Word Detective CD33.95
- 46769 Arthur's Birthday CD28.95
- 37182 Arthur's Reading Race CD29.95
- 54921 Kid Pix Studio Deluxe.....29.95

Caere

- 51163 OmniPage 8.0 Upgrade\$99.95
- 51165 OmniPage 8.0.....549
- 34314 OmniForm149.95*

Casady & Greene

- 51351 Grammarian.....\$49.95
- 30163 SpellCatcher.....49.95
- 100415 Conflict Catcher 8.....49.95*

CE Software

- 44892 QuickMail Office 5-User\$229.95
- 44893 QuickMail Office 10-User.....449.95
- 44894 QuickMail Office 25-User799.95
- 39945 QuickKeys89.95
- 52981 QuickKeys PowerPack24.95
- 57867 QuickKeys & QuickKeys PowerPack Bundle...89.95

Connectix

- 58594 RAM Doubler 8\$44.95
- 46532 Speed Doubler 854.95
- 100884 Virtual PC w/Windows 98169.95
- 50772 Surf Express34.95
- 52510 Virtual PC 2.0 Upgrade for Win95 & DOS...32.95
- 52509 Virtual PC 2.0 w/DOS.....47.95

Corel

- 100988 CorelDRAW 8.0 Upgrade.....\$149.95
- 100942 CorelDRAW 8.0489.95

DeLorme

- 46966 GPS Receiver w/Street Atlas USA 4.0\$159.95

Extreme Machine.

The perfect machine for graphics pros and regular Joes is finally here! Macintosh G3 PowerBooks are built for superior speed and performance, and deliver it all with one of the brightest 14.1" screens in the industry.

Starts At
\$2799 104250

Lease for as low as \$101.08/mo.

- Up to 300MHz G3 processor
- 32MB or 64MB SDRAM
- Up to 8GB IDE Hard Drive
- 4MB SGRAM Video Memory
- 20X CD-ROM (DVD available)
- K56flex Modem



FREE!
VST 100MB Zip Drive

\$239 Value!

*With any PowerBook G3 14.1" model purchase. Offer expires 12/31/98.

Limited Edition!

ONLY
\$2199 105774

Lease for as low as \$79.49/mo.

Only while supplies last!

- 233MHz G3 processor
- 32MB SDRAM
- 2GB IDE Hard Drive
- 4MB SGRAM Video Memory
- 20X CD-ROM
- K56flex Modem



PowerBook G3 Accessories

| | | |
|-------|-----------------------------------|------|
| 56129 | AC Power Adapters | \$79 |
| 56131 | Li-ion Rechargeable Battery | 229 |
| 56133 | Floppy Disk Drive | 109 |
| 60331 | FireWire Digital Video Kit | 299 |



Order Weekends, Get It Monday!



Order anytime on Saturday, until noon on Sunday, for Monday delivery.

HOT PRODUCTS! HOT PRICES!

Add an Accelerator Card

IXMICRO
ONLY \$279.95
59576

Add a 56K Modem

BEST DATA
ONLY \$69.95
56473

| | | |
|---------------------|---|----------|
| 43723 | Street Atlas USA 4.0 | 42.95 |
| 43724 | Street Atlas USA 4.0 & Phone Search USA 3.0 | 58.95 |
| 40204 | Phone Search USA 3.0 | 29.95 |
| Diamond Soft | | |
| 60001 | Font Reserve | \$114.95 |
| Extensis | | |
| 59681 | NEW! Extensis QX-Tools 4.0 | \$148.95 |
| 59685 | NEW! Extensis Beyond Press 4 | 489.95 |
| 51891 | PowerSuite Quark | 194.95 |
| 51959 | PowerSuite Photoshop | 194.95 |
| 41918 | Extensis Preflight Pro 2.0 | 379.95 |
| 52185 | Extensis PhotoFrame 1.0 Vol. I | 124.95 |
| 52536 | Extensis PhotoFrame 1.0 Vol. II | 124.95 |
| 52539 | Extensis PhotoFrame Vol. I&II | 194.95 |
| 102126 | Extensis MaskPro 2.0 | 289.95 |
| 46442 | Extensis QX-Effects 3.0 | 124.95 |
| 40058 | Extensis Intellihance 3.0 | 94.95 |

GT Value Products

| | | |
|-------|---|---------|
| 51584 | NEW! Top Gun | \$49.95 |
| 51598 | NEW! X-Men: Apocalypse Add-on for Quake | 19.95 |
| 43330 | Civilization II | 29.95 |
| 51582 | Deadlock | 49.95 |
| 51597 | Play to Win Casino | 19.95 |
| 40728 | Duke Nukem 3D Atomic Edition | 49.95 |
| 47430 | Duke It Out in DC Add-On | 17.95 |
| 43329 | Quake | 29.95 |
| 43331 | Master of Orion 2 | 27.95 |
| 47433 | Shadow Warrior | 27.95 |

| | | |
|---|---|----------|
| 102261 | Unreal | 44.95 |
| 48165 | Jack Nicklaus 4 | 49.95 |
| FWB Software | | |
| 58551 | Hard Drive ToolKit PE 2.5 w/FREE CD-ROM ToolKit | \$49* |
| 49791 | Hard Drive ToolKit | 94.95 |
| <i>*After mfr.'s mail-in rebate.</i> | | |
| Insignia | | |
| 101338 | SoftWindows 98 | \$164.95 |
| 50127 | SoftWindows 95 S.O. | 189.95 |
| 44701 | RealPC | 74.95 |
| Intuit | | |
| 46300 | Quicken Basic 98 | \$29.95 |
| 46302 | Quicken Deluxe 98 | 39.95 |
| 27057 | QuickBooks Pro 4.0 | 199.95* |
| 26544 | QuickBooks 4.0 | 119.95* |
| <i>*After mfr.'s rebates for previous Quicken users</i> | | |

| | | |
|----------------------|-------------------------------------|----------|
| Jian | | |
| 56908 | Marketing Builder Interactive | \$74.95 |
| Leister | | |
| 44177 | Reunion 5.0 | \$99.95 |
| McAfee | | |
| 101611 | VirusScan 4.0 Deluxe | \$9.95 |
| Macromedia | | |
| 51112 | FreeHand 8 Upgrade | \$144.95 |
| 51111 | FreeHand 8 | 394.95 |
| 56091 | Flash 3 | 294.95 |
| 55837 | Dreamweaver 1.2 | 294.95 |
| 56999 | Director 6.5 Upgrade | 394.95 |
| MetaCreations | | |
| 40267 | MetaCreations Painter 5 | \$279.95 |
| 56932 | MetaCreations Poser 3 | 189.95 |

ORDER ONLINE!

CALL or CLICK™

24 HOURS 7 DAYS A WEEK!

TOLL FREE ORDERING

www.macconnection.com

199MW



MacConnection®

The Original Macintosh Mail-Order Source - Since 1984!

800-600-9358

We carry more than 20,000 Products!

Don't see something? Just give us a call!

We did it first!

- One-Minute Mail Order
- Everything Overnight™
- Order until 2:45 a.m. ET; same-day delivery!
- Order custom-configured computers until midnight with same-day delivery!

\$450 Value!

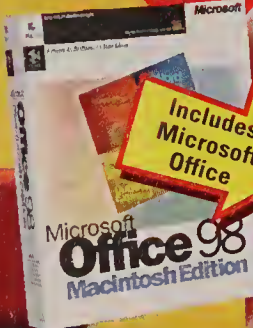

Includes Microsoft Office

Starts At **\$1599**

Lease for as low as \$57.74/mo. 101110



Monitor Sold Separately

NEW G3 Models!

The Power Macintosh G3 Desktop 266 and 300 computers deliver outstanding performance at prices you can afford. Designed to meet the needs of a wide range of users, they incorporate the PowerPC G3 processor, 512K Level 2 backside cache on the processor module, 66MHz system bus, 24X CD-ROM (one model even has Microsoft Office installed!), 32 or 64MB of RAM expandable to 768MB, 4 or 6GB hard drives and additional capabilities for graphics and audio support.

- Up to 300MHz G3
 - Up to 64MB RAM
 - 24X CD-ROM
 - Up to 6GB Hard Drive
 - 100MB Zip
- Select Models Only



Fast and Affordable. 300MHz G3 Desktops!

"Despite identical chip speeds, the Apple G3 processor outperforms the Pentium."

—Newsweek May 1999

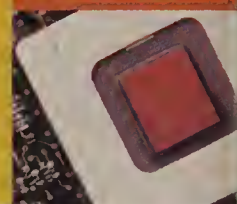

Get **\$100⁰⁰** in Connection Cash!*

CALL FOR DETAILS.



\$100 To Use On Any Product You Like!



Adobe Photos



*With purchase of any Desktop or Minitower. Ends 12/31/98.

APPLE POWER MAC® G3

| Item # | Model | Processor/Speed | RAM Std/Max | Hard Drive/Type | VRAM Std/Max | Cache/MHz | Expansion | CD-ROM | Int. Zip | Added Feat. | Price |
|--------|------------------|-----------------|-------------|-----------------|--------------|-------------|------------|--------|----------|--------------|--------|
| 101110 | G3/266 Desktop | G3/266MHz | 32/768 | 4.0GB; IDE | 2MB/6MB | 512K/133MHz | 3PCI/1 bay | 24X | — | — | \$1599 |
| 105895 | G3/266 Desktop | G3/266MHz | 64/768 | 4.0GB; IDE | 2MB/6MB | 1MB/150MHz | 3PCI/1 bay | 24X | — | 56K Modem | 1799 |
| 101111 | G3/300 Desktop | G3/300MHz | 64/768 | 6.0GB; IDE | 2MB/6MB | 1MB/150MHz | 3PCI/1 bay | 24X | Y | — | 1999 |
| 101746 | G3/300 Minitower | G3/300MHz | 64/768 | 8.0GB; IDE | 6MB/6MB | 1MB/150MHz | 3PCI/1 bay | 24X | Y | Video In/Out | 2399 |
| 101744 | G3/333 Minitower | G3/333MHz | 128/768 | 9.0GB; U/W SCSI | 6MB/6MB | 1MB/167MHz | 3PCI/2 bay | 24X | — | — | 2999 |

- 56085 FreeHand Design in Motion Suite.....**494.95**
- 56089 Flash 3 Upgrade.....**94.95**
- 56091 Flash 3.....**294.95**
- 55837 Dreamweaver 1.2.....**294.95**
- 56999 Director 6.5 Upgrade.....**394.95**

MetaCreations

- 40267 MetaCreations Painter 5.5 Web Ed.....**\$299.95**
- 40268 Painter 5.5 Upgrade.....**94.95**
- 56932 MetaCreations Poser 3.....**189.95**
- 52794 Painter Classic.....**94.95**
- 53480 Painter 3D.....**279.95**
- 56935 Kai's SuperGoo.....**48.95**
- 24509 Kai's Power Tools 3.0.....**124.95**
- 48763 Bryce 3D.....**179.95**
- 43679 Ray Dream Studio 5 Upgrade.....**94.95**
- 43677 Ray Dream Studio 5.....**279.95**
- 46400 Ray Dream 3D.....**94.95**
- 56931 Infini-D 4.5.....**499.95**

Microsoft

- 50177 Office 98 Upgrade.....**\$258.95**
- 50174 Office 98.....**349.95****
- 54901 Office 98 At A Glance.....**16.95**
- 50183 Office 98 Gold Upgrade.....**359.95**
- 50182 Office 98 Gold Edition.....**439.95****
- 50185 Word 98 Upgrade.....**129.95**
- 50184 Word 98.....**359.95**
- 50193 PowerPoint 98 Upgrade.....**129.95**
- 50192 PowerPoint 98.....**359.95**

- 50189 Excel 98 Upgrade.....**129.95**
- 50188 Excel 98.....**359.95**
- 53045 Office 98 Upgrade - Level A Vol. License...**249.95***
- 53042 Office 98 - Level A Vol. License.....**369.95***

Mindscape

- 60133 Mavis Beacon Teaches Typing 9.0.....**\$34.95**
- 60113 National Geographic 109 Years.....**159.95**

NetObjects

- 58771 NetObjects Fusion 3.0 Upgrade.....**\$94.95**
- 57929 NetObjects Fusion 3.0.....**194.95**

NewTek

- 54127 Inspire 3D.....**\$399.95**
- 45689 LightWave 3D Upgrade.....**449.95**
- 51594 LightWave 3D 5.5.....**1789.95**

Niles

- 53475 EndNote 3.0.....**\$169.95**

PaceWorks

- 52993 ObjectDancer 1.5.....**\$194.95**

Pantone

- 29334 Survival Kit w/ Formula & Solid Process Guides.....**\$149.95**
- 54270 Pantone Office Color Assistant.....**24.95**
- 43108 Pantone Personal Calibrator.....**44.95**
- 43106 Pantone ColorWeb Pro.....**54.95**
- 28902 Pantone Formula Guide.....**59.95**
- 27656 Pantone Process Guide.....**59.95**

Design in Motion Suite Upgrade
FreeHand 8, Flash 3 & Insta.HTML 2
56088
Only \$294.95

- 32646 Pantone Solid to Process Guide.....**79.95**
- 28901 Pantone Hexachrome Selector.....**79.95**
- 31756 Pantone HexWrench.....**339.95**
- 31752 Pantone ColorDrive/Survival Kit Bundle...**194.95**
- 31749 Pantone ColorDrive 1.5.3 w/ColorWeb.....**94.95**
- 31755 Pantone ColorWeb.....**29.95**

Qualcomm

- 51944 Eudora Pro 4.0.....**\$38.95**
- 55093 Eudora Pro 4.0 5-User.....**159.95**

Quark

- 47735 QuarkXPress 4.03.....**\$679.95***

Symantec

- 55153 Norton AntiVirus v5.0.....**\$69.95**
- 101293 Norton Utilities 4.0.....**49.95***
- 102496 Norton Utilities 4.0 10-Pack.....**799.95**
- 3955 Suitcase.....**69.95**
- 43831 ACT! 2.8.....**159.95**
- 38176 Suitcase Upgrade.....**39.95**

- 43560 ACT! 2.8 Upgrade.....**69.95**
- 49629 Visual Café for Java PDE.....**279.95**
- 48815 Visual Café for Java DDE.....**499.95**

Thursby Software

- 49708 DAVE 2.0.....**\$124.95**
- 49709 DAVE 2.0 5-User.....**499.95**
- 49710 DAVE 2.0 10-User.....**849.95**
- 49711 DAVE 2.0 25-User.....**1999.95**

Xaos

- 40314 Total Xaos Bundle.....**\$169.95**
- 37495 Terrazzo 2.0.....**94.95**
- 35942 TypeCaster 1.15.....**94.95**
- 37496 Paint Alchemy 2.0.....**94.95**

Xerox

- 51427 TextBridge Pro 8.0.....**\$49.95**

UPGRADES

Newer Technology

- Apple PowerBook 1400, 2400
- 54335 NUpowr 1400 G3 216MHz/512K.....**\$679**
- 54339 NUpowr 2400 G3 240MHz/512K.....**829**
- 54340 NUpowr 1400 G3 250MHz/1MB.....**979**
- Apple Power Mac 7300, 7500, 7600, 8500, 9500, 9600; UMAX 1700, 5900
- 52512 MAXpowr G3 Series 220MHz/110/512K.....**449**
- 45169 MAXpowr G3 Series 250MHz/125/512K.....**599**
- 54457 MAXpowr G3 Series 275MHz/138/512K.....**799**

The Pros' Choice.



Starts At
\$2399
 Lease for as low as \$86.63/mo.
 101746
Built-in 10BaseT

Monitor Sold Separately

Power Mac G3 Minitower 333MHz.

Delivering scorching speed and true expandability, the new Power Mac G3 models are designed to serve the needs of graphics and design professionals, content creators and general productivity users. Every model includes a high-capacity hard disk drive and at least one expansion bay for additional storage, plus a 24X CD-ROM, built-in 10BaseT Ethernet support, and high-quality video and audio. You also can add the Apple FireWire option that enables you to connect your digital video camcorder to produce professional-quality digital video easily and affordably. Choose the system that's right for you, and hang on for the ride!

Get Over **\$2500** in Rebates & Offers*

Up to **\$100** Scanner Rebate!
 Up to **\$100** Software Rebate!
 Up to **\$65** Printer Rebate!

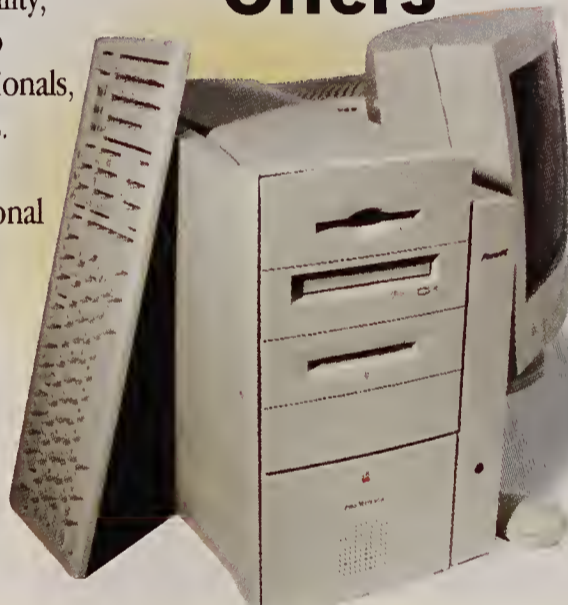

- Up to **333MHz G3**
- Up to **128MB SDRAM 768Max.**
- Up to **9GB Ultra/Wide SCSI Hard Drives**
- Up to **6MB VRAM**
- 24X CD-ROM**
- 100MB Zip**
Select Models Only

* WITH APPLE SUPER-SAVINGS COUPON BOOK included with every Macintosh purchase. Offers effective through 1/31/99.

OUR POLICY • VISA, MASTERCARD, AMERICAN EXPRESS, and NOVUS cards. No surcharge. Orders are shipped via Airborne Express at \$5.95 per order up to 3 pounds; over 3 pounds—\$5.95 plus \$1.25 per pound (or fraction thereof). This does not apply to orders shipped outside the Continental U.S. or to APO and FPO addresses. Shipping to Hawaii, Alaska, Canada, Puerto Rico, and the U.S. Virgin Islands may require additional time and charges—call 800-800-2222 for shipping information. International orders, add 2% surcharge and \$2.30 insurance. A contact phone or fax number is required. You will be responsible for actual shipping charges, as well as tax and duty. Call 603-446-2222 or fax 603-446-7791 for information. Items of excessive size and/or weight may require additional delivery time. Checks must be drawn on a U.S. bank in U.S. dollars. Upon receipt and approval, personal and company checks clear the day they are received for immediate shipment.

OUR RETURN POLICY • Some products carry a money-back guarantee (MBG), allowing you to return your purchase for a full refund, excluding shipping charges, if you're not completely satisfied. Be sure to ask your Sales Consultant if the product(s) you're ordering carry the MBG. • All products are covered by their respective manufacturers' warranties. Within thirty (30) days of purchase, we will replace or repair, at our sole discretion, any product that is deemed defective. After 30 days, the manufacturer's warranty process must be followed. • All non-defective returns authorized by MacConnection are subject to a 15% restocking fee, and must be completed within 30 days of invoice. • PLEASE NOTE: Due to restrictions placed upon us by the manufacturers, computers and printers are returnable in the first 30 days for repair only. Computers, printers, LCD projectors, and Quark products are not returnable for credit or exchange. • All returns require prior authorization and must be returned with all original packaging, accessories and documentation, including registration card, so please don't discard these materials. To request a return authorization (RMA), please call 1-800-800-0011. RMAs are valid for 10 days. Incomplete or unauthorized returns will be refused. **YEAR 2000 DISCLAIMER** PC Connection, Inc. encourages its suppliers to make their products and services year 2000 compliant. However, PC Connection, Inc. does not represent or warrant that any product advertised or sold by it will not experience date related errors resulting from the turn of the century (the year 2000). Any information provided on products have been furnished by the manufacturer. PC Connection, Inc., Milford, NH MacConnection & the raccoon characters are registered trademarks of PC Connection, Inc. All other trademarks remain the property of their respective companies. Prices and promotions are subject to change without notice. We are not responsible for typographical errors.

- | | | |
|----------------------------|---------------------------------------|------|
| 102716 | MAXpowr G3 Series 333MHz/166/1MB | 1199 |
| 102717 | MAXpowr G3 Series 366MHz/183/1MB | 1499 |
| 102718 | MAXpowr G3 Series 400MHz/200/1MB | 1999 |
| Apple Power Mac 6100 | | |
| 51096 | MAXpowr G3 210MHz/512K | 499 |
| 51097 | MAXpowr G3 240MHz/1MB | 699 |
| Apple Power Mac 7100, 8100 | | |
| 51098 | MAXpowr G3 210MHz/512K | 599 |
| 51099 | MAXpowr G3 240MHz/1MB | 799 |
| 57443 | MAXpowr G3 Series 220MHz/512K non-AV | 579 |
| 57441 | MAXpowr G3 Series 240MHz/1MB non-AV | 779 |
| Power Computing PowerBase | | |
| 52517 | MAXpowr G3 Series 220MHz/110/512K | 549 |
| UMAX C500, C600 | | |
| 52515 | MAXpowr G3 Series 220MHz/110/512K | 549 |
| Apple Power Mac G3 series | | |
| 102719 | NEW! MAXpowr G3 Series 333MHz/166/1MB | 1199 |
| 102720 | NEW! MAXpowr G3 Series 366MHz/183/1MB | 1499 |
| 102721 | NEW! MAXpowr G3 Series 400MHz/200/1MB | 1999 |

Orange Micro

- | | | |
|--------|-------------------------------------|-------|
| 58061 | Orange PC 626 PR200 MMX/16MB | \$499 |
| 102181 | Orange PC 627 IDT200 MMX/16MB/WinNT | 549 |
| 104774 | PCFX | 649 |

UPS/SURGE

American Power Conversion

- | | | |
|-------|---------------------------------|----------|
| 56170 | Back-UPS Pro 650 PNP (410-watt) | \$279.95 |
| 21929 | Back-UPS Pro 1000 | 389.95 |

- | | | |
|------------------|---|---------|
| 3858 | Back-UPS 400 (While supplies last) | 99.99* |
| 9685 | SurgeArrest Pro 7 | 29.95 |
| Belkin | | |
| 53628 | ReSource UPS | \$89.95 |
| 102124 | SurgeMaster w/TelClear | 29.95 |
| 52147 | SurgeMaster II Premiere | 27.95 |
| 102124 | SurgeMaster II Premiere w/TelClear | 29.95 |
| 52145 | SurgeMaster II Gold | 34.95 |
| TrippLite | | |
| 100094 | Internet Office 400VA UPS While supplies last | \$89.95 |

VIDEO CARDS

ATI Technology

- | | | |
|--------|----------------------|--------|
| 103289 | Nexus GA - 16MB, PCI | \$489 |
| 49733 | XCLAIM VR, 4MB | 239.95 |



ix MICRO

ix 3D Ultimate Rez
 128-bit, 8MB VRAM
102015 Only \$199.95*
 *When bundle with a system or 21" monitor.

IX Micro

- | | | |
|-------|-------------------------------|--------|
| 47782 | Ultimate Rez - 8MB, PCI, VRAM | \$469 |
| 52334 | Pro Rez - 8MB, PCI, SGRAM | 279.95 |
| 52336 | Mac Rocket - 4MB, PCI, SGRAM | 219.95 |
| 59576 | Road Rocket - 4MB, PCI, SGRAM | 279.95 |



CALL or CLICK™

24 HOURS
 7 DAYS
 A WEEK!



TOLL FREE ORDERING

www.macconnection.com

199MW

MacConnection®

The Original Macintosh Mail-Order Source—Since 1984!

800-600-9358

Choose 145 at www.macworld.com/getinfo

MACWORLD January 1999 27



NEW VERSION!

MiniCAD[®] 7

Windows[®]/Macintosh[®]
The Easiest, Most Cost-Effective Way to Design



For more than a decade, professionals seeking an out-of-box CAD solution have selected the award-winning MiniCAD. This stand-alone program lets you create everything from precise working drawings to sophisticated client presentations

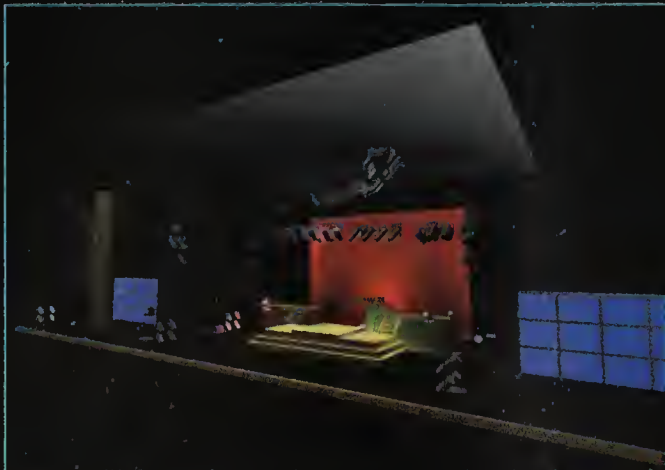

- Precise Sun Positioning
- Expression Evaluation Inside Textboxes
- Automated Databases/Spreadsheets
- Multi-Decimal Dimensioning
- Rotatable Grid and Customizable Coordinate System
- Plus Dozens of Performance and Interface Enhancements

To learn more about MiniCAD's extensive feature set and why the program has been called "the easiest, most cost-effective way to design," call 1-888-MINICAD or visit our Web site: www.diehlgraphsoft.com MiniCAD 7, which retails for a suggested price of \$795, comes with 18 months of FREE Tech Support and a 30-Day Money-Back Guarantee!

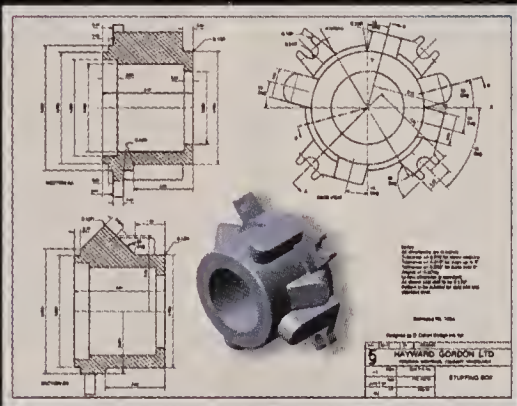

tries—multi-decimal accuracy for precise drafting, a built-in database/spreadsheet to track costs and materials, extensive

Now this total CAD solution speeds your design process with these new features:

- True 3D Boolean Solid Modeling
- DWG and DXF Import/Export
- Dual-Unit Dimensioning
- Auto Wall Framing
- QuickDraw 3D Rendering
- Associative Hatching
- Automatic Wall Joining
- Next-Generation SmartCursor

to extensive materials lists and cost estimates.

As always, MiniCAD 7 offers the same core features that have made it the program of choice for design professionals in more than 80 coun-

tries—multi-decimal accuracy for precise drafting, a built-in database/spreadsheet to track costs and materials, extensive library of industry-specific symbols, cross-platform compatibility (Mac and Windows), and a macro programming language for automating complex and routine tasks.

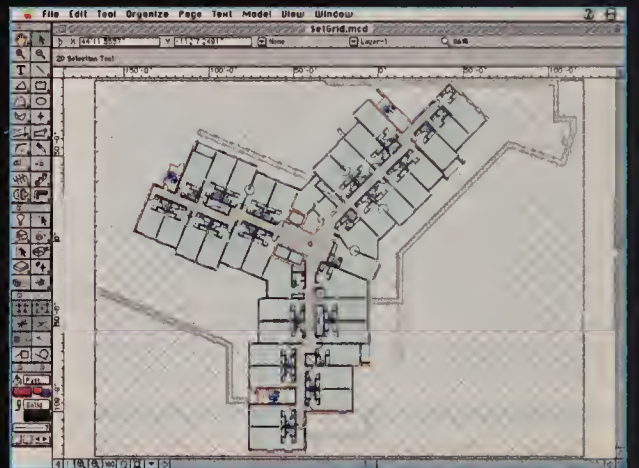

MiniCAD 7—The only thing small is the price.

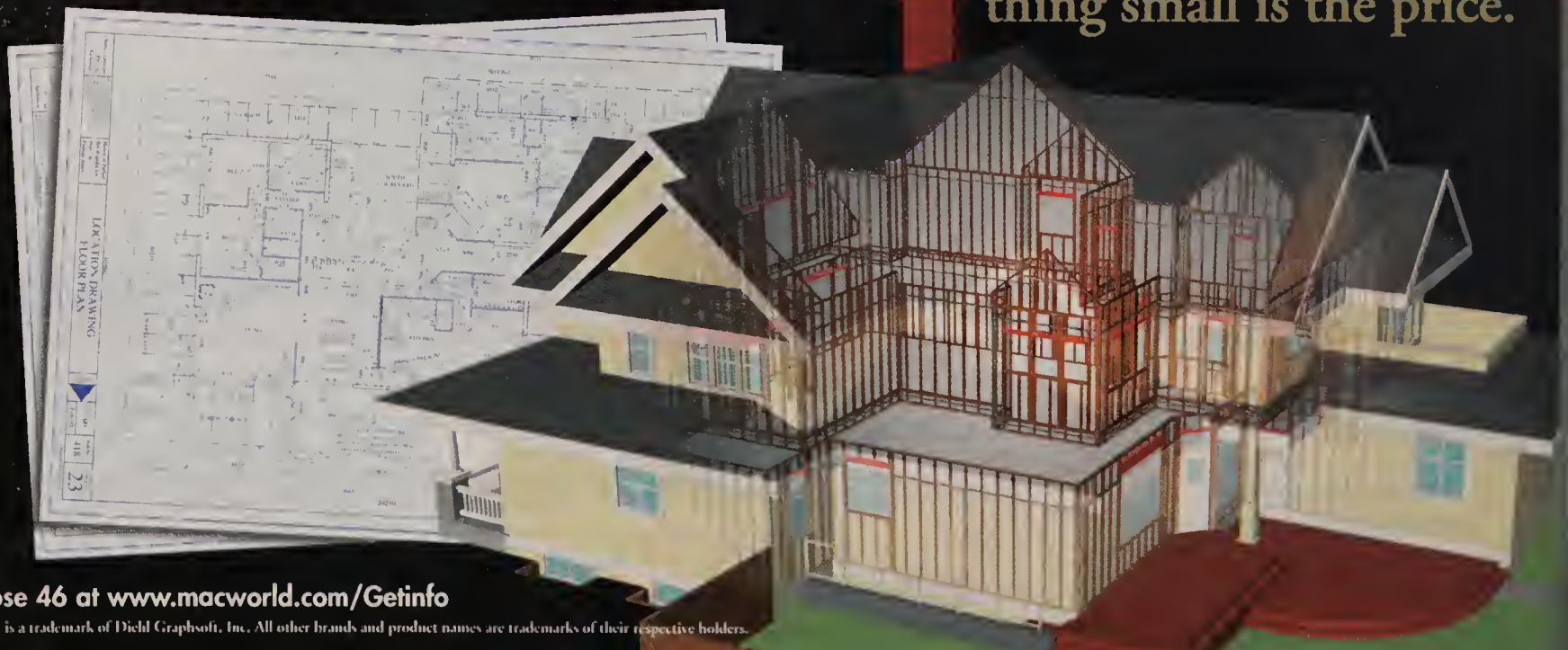

Choose 46 at www.macworld.com/Getinfo

MiniCad is a trademark of Diehl Graphsoft, Inc. All other brands and product names are trademarks of their respective holders.

MACWORLD VOUCHER SUBSCRIPTION SAVINGS

This voucher entitles you to save up to 81% off the cover price when you subscribe to MACWORLD.
BONUS: the Clip Art Sampler CD-ROM — FREE with your paid order.

CHECK ONE:

- 2 YEARS (24 ISSUES) \$35.97 — **SAVE 81%**
- 1 YEAR (12 ISSUES) \$19.97 — **SAVE 79%**

| | | |
|---------|----------------|-------|
| Name | (Please Print) | 5NRB1 |
| Company | | |
| Address | | |
| City | State | Zip |
| E-Mail | | |

SAVINGS SUMMARY

ANNUAL COVER PRICE
\$95.88

YOUR SPECIAL RATE
\$19.97

SAVINGS OF:
\$75.91

BONUS
CLIP ART
Sampler CD-ROM

Payment enclosed.
 Bill me later.

Annual newsstand price \$95.88. Non-U.S. orders add US\$20 postage. Canadian GST included.
Your FREE software will be shipped upon payment.

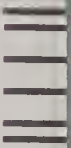

BUSINESS REPLY MAIL
FIRST-CLASS MAIL PERMIT NO. 66 BOULDER, CO

POSTAGE WILL BE PAID BY ADDRESSEE



Subscription Department
PO Box 54506
Boulder CO 80323-4506



NO POSTAGE
NECESSARY
IF MAILED
IN THE
UNITED STATES



The Vision Thing

by Andrew Gore

"Escape from the Cubicle Farm"

POWERBOOK IN HAND, YOU CAN FREE YOURSELF FROM YOUR DESK AT LAST

THROBBING TECHNO music plays over a darkened movie screen. As the music builds, the silhouette of a figure comes into focus—long hair blowing in the breeze, muscular build outlined in eclipsed light. As the camera cuts in, we see his face emerge from shadow: scars, a black eye patch, and a look that could curdle milk.

As the camera pans down, we see that our dark figure has something flat and black under his arm. A bomb? A briefcase with top secret papers? No. As he grabs the object with a free hand and flips it open with the grace of a ninja, we hear that familiar orchestral hit as the PowerBook G3's screen comes to life. On it is displayed the title of the film: *Escape from the Cubicle Farm*.

Being There

This homage to the campy 1981 adventure flick *Escape from New York* could be shot anywhere in the "Dilbert"-esque landscape of corporate America. Our protagonist (call him Snake) embodies the frustration of cubicle life, where nineteenth-century management techniques collide with twenty-first-century floor planning. He is the true Road Warrior (1981 was a good year for action movies), here to liberate us from the shackles of the urban/suburban commute, the 9-to-5 grind, and the belief that the only place productive work can take place is in a 10-by-10 gray box.

OK, so maybe this scenario is a bit over the top. But you can see the merit of my movie's theme: thanks to technology, productivity is no longer a destination. Look at the boom in home-office computing: Do you think there would have been nearly as much growth in home-based businesses and flexible work hours if it weren't for the advent of remote access? And just think about how much productivity employees on the go have gained now that they can carry their

entire office infrastructure in a black nylon bag. With Apple's latest generation of PowerBooks, there really isn't anything you can do only in the office, except maybe exchange a few sly looks during a dull meeting.

And then there are the things you *can* do unchained from your desk: check e-mail, surf the Web, access company databases, design and deliver sophisticated presentations, edit an image in Photoshop, download high-resolution photos from a digital camera, crunch the department budget, write the Great American Novel, watch a full-length movie. With the addition of large color screens, G3 processors, DVD-ROM drives, CardBus

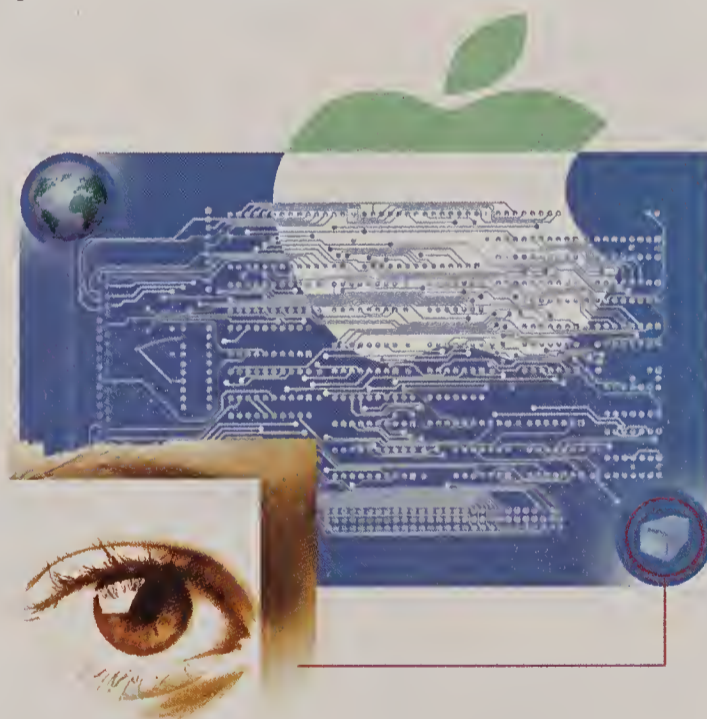

slots, and multiple storage and battery bays, Apple's current portables are more powerful and flexible than any of their predecessors. In fact, there is now very little a desktop Mac can do that a PowerBook can't (see "The PowerBook Field Guide," in this issue).

Breaking Free

Unfortunately, one of the things a PowerBook can't do is change the attitude of managers who believe that work happens only under their watchful gaze. Now that

PowerBooks have become so affordable—a reasonably well-equipped portable with a 14-inch screen goes for \$2,799—in many cases there's no reason for employers to buy desktop machines. Think about how much more productive you could be if you folded up your office computer and took it home at the end of the day. You could get home in time for dinner with the family and then finish up any remaining work while the kids watch *The Simpsons*. If one of them gets sick the next morning, you could stay home and care for him or her and still be able to get work done. Imagine that—taking care of your familial obligations without missing work.

Of course, this might give you ideas.

Maybe you could stay home one day a week *every week*. You'd still get your work done—maybe even more work than usual—without the usual workplace distractions. And you could win back the lost commute hours and what strands of your sanity you lose in daily gridlock. Your company would have to be enlightened enough to understand that, when managed responsibly, flexible hours can mean happier and more-productive employees.

Every enabling technology comes with a challenge: that you be open enough to the new possibilities it enables. Now that

mobile computing has truly come of age, the next great challenge is for the companies that embrace this technology, and for the employees who use it, to be responsive and responsible enough to get the most out of it.

Or as Snake might put it, that new PowerBook G3 means freedom—but only if you've got the guts to use it.

Well, do you? **m**

The explosive capsules implanted in Andy's neck are set to go off in 24 hours. Send your comments to visionthing@macworld.com—but make it quick.

FEATURES that

Elaine Lau
TECHNICAL SUPPORT REPRESENTATIVE



Mark Vappi
SOFTWARE DEVELOPMENT MANAGER

Tara Rolfe
BUSINESS UNIT MANAGER

don't fit

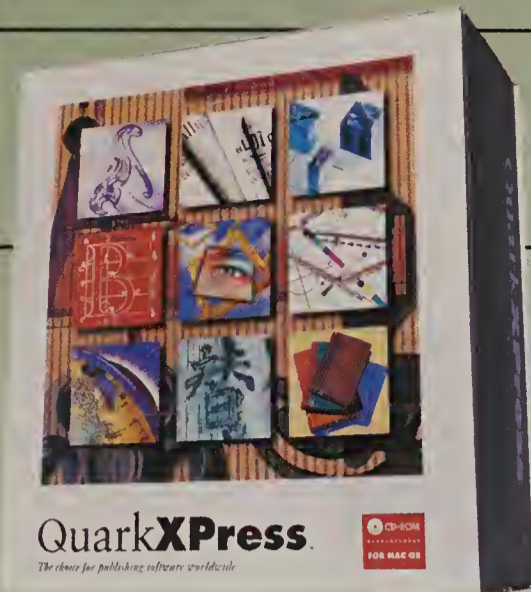

IN
the
BOX

The choice for publishing software worldwide.

"Features" like Mark, Elaine, and Tara —

just three of the people who are as much at the core of QuarkXPress™ 4.0 as the text to box and long-document features. Whether it's filling your order, working with you on technical issues, or reviewing your ideas for future versions, they stay focused on you because you are key to the success of QuarkXPress.

AND **QuarkXPress 4.0** can help you create successful, exciting, and effective pieces that deliver your message with impact, from the simplest brochure to the most complex catalogs and magazines. That's why over 2 million QuarkXPress users in a variety of industries would never even consider the idea of publishing with anything else.

We want to hear from you. Call us at (800) 995.4343 with questions, comments, and ideas.

QuarkXPress 4.0
FOR MAC OS

(800) 676.4575

for upgrades

<http://www.quark.com>

*for a list of resellers, product information,
and to download updaters*

QUARK™

Choose 77 at www.macworld.com/getinfo



**The ideal Mini DV
for multimedia.**

- Normal Movie, Photo (Still) or Digital Motor Drive (30 stills per second)
- Progressive Scan CCD with RGB filter
- 14x Optical/35x Digital zoom with Optical Image Stabilization
- Select EOS Flash compatibility

optura

There's no such thing as a digital camcorder for So we made digital

Each one has an IEEE 1394 digital terminal for computer connectivity, get from Canon lenses, and offers the superior digital video and audio



**The ultra compact
Mini DV is our smallest,
most portable ever.**

- 11x Optical/44x Digital zoom with image stabilization
- 2.5" LCD viewscreen
- Detachable viewfinder
- Digital Stereo Sound

ZR



Our most versatile Mini DV yet.

- 16x Optical/64x Digital zoom with Optical Image Stabilization
- 2.8" LCD viewscreen
- Exclusive Built-in Video Editor
- Select EOS Flash compatibility
- "Clear Still" technology

VISTURA

everybody.

camcorders for everybody.

shoots stills as well as video, gives you picture clarity you can only quality of a Mini DV digital camcorder. And yet, each one is different.



The ultimate Mini DV camcorder.

- Exclusive XL Mount interchangeable lens system
- 3CCD with exceptional low light performance
- 16x SuperRange Optical Image Stabilizer lens standard
- Extra Wide-Angle 3x zoom lens optional
- Manual control

XL1

Canon

www.canondv.com

If this is Norton™...

This is TechTool® Pro:



When your Macintosh computer is not operating correctly, having the right tool to find and fix the problem is important. And as any technician will tell you, you can never have too many tools. TechTool Pro 2 checks more aspects of your Macintosh than any other utility available. Besides repairing and recovering damaged drives (including those with the new HFS+ format), you can also test all those other critical parts of your system that our famous competitor ignores like RAM, CPU, floppy drives, scanners, modems, Internet connections, CD-ROM drives and much, much more.

But just because TechTool Pro is the most advanced Macintosh troubleshooting utility available doesn't mean that it's difficult to use. In fact, we've added an easy-to-use interface that makes checking and fixing your Macintosh a snap. For the advanced user, our expert mode allows you to control and configure TechTool Pro in almost any way you wish.

So if your Macintosh troubles are getting you down, check out TechTool Pro. After all, you have the most powerful computer in the world. Shouldn't you be using the most powerful utility?



Fix different.™

MicroMat Inc.
800-829-6227
707-837-8012
FAX: 707-837-0209
info@micromat.com
www.micromat.com

News

systems

G4 CPUs Set to Take Flight

MOTOROLA FORMALLY ANNOUNCES ITS NEXT-GENERATION CHIP

by Henry Bortman

With all the noise being generated by Intel about the forthcoming Merced processor, you might have missed Motorola's formal announcement of its own new chip, the G4. Motorola offered some details about the G4 months ago (see "Motorola CPU to Boost Multimedia Performance," *News*, August 1998), but now it's official.

Speedup As expected, Motorola's first G4's (still targeted for mid-1999) will implement AltiVec, a new set of PowerPC instructions paired with a new vector-processing unit that together enable the chip to perform calculations on up to 16 data elements simultaneously. For example, an Adobe Photoshop filter rewritten to take advantage of AltiVec could work on 16 pixels at a time instead of 1, offering significant speed improvements.

Motorola says that in one real-world test, an AltiVec-equipped chip ran the Photoshop Median filter 11 times faster than did a chip without

AltiVec. It also looks as if we won't have to wait long for AltiVec-enabled software once systems using the chips become available. Motorola has been working with key software vendors for two years to pave the way for AltiVec. When G4 Macs arrive on the market in 1999, Motorola says the software will be ready.

Spec Sheet Motorola has promised that the first G4

processors will run at speeds of at least 400MHz. However, other details are fuzzy. The CPU will feature a built-in cache to speed processing, but it is unclear how big the cache will be. Performance will also depend on system- and cache-bus speeds, questions that Apple has to answer in its Mac logic board designs.

Also unclear is whether Apple will support the G4's multiprocessor capability.

Unlike its G3 predecessor, the G4 can run in a four- or eight-processor environment. In the past, Apple has left design and support of multiprocessor systems largely to other companies, such as DayStar. But there's been nary a peep from Cupertino about Apple's multiple-G4 plans.

Apple also remains mum on whether it will introduce G4's into its PowerBook line.

continues



However, given that the G4 has the same power-management capabilities as the G3 and stays equally cool, it seems likely that Apple will include the new chip in its high-end portable systems.

The Menace of Merced Should you be worried about Merced? Probably not. Merced isn't due until 2000, and it's not aimed at the desktop market. It's for big iron—high-end servers and technical workstations—and will be priced accordingly. Plus, it will come in a package almost as big as a videocassette.

However, Intel's forthcoming Katmai processor— heir to the current Pentium II line—may be cause for concern. Katmai (a code name) is due in the first quarter of 1999, just before the G4. It

will be introduced at speeds of 450MHz and 500MHz, and designed for systems with 100MHz system buses.

Katmai narrows the theoretical performance gap between Altivec and MMX. Pentium processors with MMX can perform four simultaneous integer operations but just one floating-point operation. Katmai processors can perform up to four simultaneous floating-point operations.

Altivec, with its ability to perform 16 simultaneous operations, should be able to outrun Katmai processors, at least in theory. But spec sheets are easy to write. We'll have to wait until Katmai and G4 processors are available in commercial systems to see which actually wins the race.

multimedia

Macromedia, GoLive Spin Dynamic Web

MACROMEDIA PREPARES DREAMWEAVER 2.0

by Cameron Crotty

For aspiring moviemakers the question is, "What producer are you talking to?" But if you're building a Web site, the question is, "What server are you talking to?" Macromedia has just announced Dreamweaver 2.0, with extensive tools for building links to content servers. Meanwhile, GoLive is working to parlay CyberStudio into a complete Web publishing system, and FileMaker (née Claris) is billing Home Page as an add-on to the FileMaker Pro server. However, just as in Hollywood, there's always an independent director or two. Adobe is pitching PageMill 3.0 as the authoring tool for the rest of us—without all that fancy dynamic content.

Macromedia Dreams Ever since Dreamweaver 1.0 shipped, Macromedia (415/252-2000, www.macromedia.com) has been playing second fiddle (or worse) to GoLive's immensely popular CyberStudio. Part of the reason lies in Dreamweaver's clunky interface, and Macromedia admits that even Dreamweaver devotees complain that the Mac version is a bit slow. So version 2.0 sports a raft of interface improvements and a 50 percent speed boost, Macromedia says.

Users can also look forward to new table-editing features, such as sorting capabilities and noncontiguous cell selection. A new global

search-and-replace tool will simplify cross-site changes.

However, the crown jewel in Dreamweaver 2.0, as Macromedia sees it, is the program's support for dynamic publishing. Web designers can preview server-delivered dynamic content—such as tables from a database or a catalog entry from an e-commerce server—as they build their pages. Initially, Dreamweaver will ship with tools to work with servers from iCat, Broadvision, Tango, and Cold Fusion, among others; Macromedia says that adding a tool is as simple as dropping a chunk of code into a Finder folder. Dreamweaver 2.0 is expected to ship December 11, 1998, for \$299.

GoLive Networks Meanwhile, GoLive (650/463-1583, www.golive.com) is working on the three-piece GoLive Web Publishing System, which allows designers, writers, and others to collaborate on Web production projects. Designers will use GoLive's CyberStudio Publishing Edition to create Web-page templates. Meanwhile, content creators can add text and images with GoLive's CyberWriter client software, which works with Microsoft Internet Explorer or Netscape Navigator, version 4 or later. Content is placed on the Web using a Web server called CyberServer—based on a SQL database—that runs on Linux, AIX, Sun Solaris, Windows 98, Windows NT, Mac OS, and Mac OS X Server systems.

GoLive expects the Web Publishing System to ship by January 1999, with prices starting at less than \$1,000 for a two-user configuration.

Adobe Simplifies Adobe PageMill was among the first Web authoring tools to hide the complexity of HTML behind a WYSIWYG interface, and Adobe (408/536-6000, www.adobe.com) hopes that the latest version will



Micro Dry Printer Climbs the Alps

AS HEWLETT-PACKARD, TEKTRONIX, QMS, AND OTHERS push the envelope on color laser printers, Alps Electric (408/432-6000, www.alpsusa.com) has done the same with its proprietary Micro Dry printing technology. The \$599 MD-5000 holds up to seven interchangeable ribbon cartridges that let you print with metallic inks, gold and silver foil, and a glossy overcoat in addition to CMYK. You can also use a Vphoto Primer cartridge that allows printing on plain paper by applying a thin transparent coating under the image. The printer connects to your Mac's SCSI port.

A \$99 dye-sublimation option lets you print continuous-tone images using CMY primary colors plus an overcoat. Other options include a \$99 USB connection for iMac users and a \$199 PostScript 3 kit.—STEPHEN BEALE

appeal to Web authors who aren't necessarily full-time designers.

PageMill 3.0 offers improved site-management capabilities, better table- and frame-editing tools, and in-line previewing of plug-ins and Java applets. The \$99 package, which is available now, also includes a limited edition of Adobe Photoshop.

graphics

Deneba Canvas Moves Upstream

UPGRADE BANKS ON
SPRITE TECHNOLOGY

by Stephen Beale

Deneba Canvas has long occupied a middle ground in the Mac graphics market. Combining vector-illustration, image-editing, and page-layout functions in a single package, it was seen as the graphics equivalent of ClarisWorks. Its components offered most of the core features of such leading stand-alone applications as Adobe Photoshop, Adobe Illustrator, and QuarkXPress but lacked many of the high-end, cutting-edge functions of those programs. Now, with the introduction of Canvas 6, Deneba (305/596-5644, www.deneba.com) hopes to steal some of its competitors' thunder and expand its appeal to graphics professionals.

The key to Deneba's strategy is a new technology called SpriteLayers. A SpriteLayer is an object that contains text, a bitmapped image, or a vector graphic. You can mix different kinds of SpriteLayers on the same document layer. Any SpriteLayer can be made trans-

parent, and you can attach objects to each other to create masking effects. In addition to adjusting an object's overall transparency, you can use transparency gradients to create effects in which one object gradually fades away to reveal an object underneath. You can also create bitmapped alpha channels that act as transparency masks on vector, raster, or text objects.

The upgrade adds technical-drawing features borrowed from CAD software, including the Fillet tool, for creating precisely rounded corners, and a guides layer that can be placed behind or in front of objects. New image-editing features include additional built-in filters and the ability to import Photoshop layers. New page-layout capabilities include Master Layers, which let you mix and match master-page elements, and an Auto-Correct text-editing feature that resembles the one in Microsoft Word.

Deneba has also spruced up the Canvas interface, which now features a customizable tool bar and keyboard shortcuts. You can assign shortcuts to object attributes such as



color, stroke, and style. If you drag a vector object to the Inks palette, Canvas automatically extracts the colors and adds them.

Deneba Canvas 6 is set to ship by the time you read this. The company's estimated price is \$349; users of competing graphics programs can get the new version for \$199.

publishing

Olympus Touts New Cameras

D-620L, D-400 MODELS
OFFER 3X ZOOM AND
MEGAPIXEL RESOLUTION

by Stephen Beale

Olympus America (516/844-5000, www.olympus.com) has finally done its popular D-600L digital camera one better by introducing the D-620L, a \$1,199 single-lens reflex model that can capture images about as rapidly as you can snap them. Olympus has also unveiled the D-400 Zoom, a \$799 point-and-shoot camera. Both are scheduled to ship by the time you read this.

Filmless Photography

Olympus touts its D-620L as a "filmless photography" product that happens to use digital technology. Like its predecessor, it's a single-lens reflex camera that features 3X zoom and a 1,280-by-1,024-pixel progressive-scan CCD. But thanks to a new memory buffer, there's almost no waiting as you capture images. You can snap them one at a time or use a burst mode that takes up to five pictures at 3.3 frames per second.

The D-620L also features three prefocus settings (close-up, medium-range, and long-range) and a synchronization connector for external flash in addition to its four built-in flash modes, which include backlight and fill flash. The camera is bundled with an 8MB SmartMedia card, four rechargeable nickel-metal-hy-

continues

Character Builder Now you can create complex typefaces with thousands of characters, including Japanese-language kanji fonts. Pyrus North America's (410/987-5616, www.pyrus.com) \$799 **Composer** is similar to Macromedia's Fontographer but adds the ability to create double-byte fonts with up to 16,384 characters.

Cyber Storage The Internet can do more than keep up with the latest political scandals. You can also use it to back up your data. Dantz Development's (925/253-3000, www.dantz.com) **Retro-spect 4.1** copies files to certified Internet backup sites, as well as to disk, cartridge, and tape. The full package costs \$249; an upgrade from version 4.0 costs \$29.95.

Bad Files Gone Good **Markz-Tools III**, an upgrade to Markzware Software's (949/756-5100, www.markzware.com) \$199 QuarkXPress add-on package, features seven QuarkXTensions, including a Conversion Module that lets users of older QuarkXPress versions open files created with newer ones; a Salvage Module that recovers damaged files; a Scavenge Text Module that extracts stories from document files; and a Gray Preview Module that grays out picture previews to save file space.

For Your iMac Don't like the round mouse that ships with the iMac? Macally's (626/338-8787, www.macally.com) \$49 **iMouse** has a traditional shape but retains

continues

Product WATCH

the iMac's translucent Bondi blue color scheme.

iMac owners in need of a printer may find relief with Infowave's (604/473-3600, www.infowave.com) **PowerPrint USB**. The \$99 adapter lets users connect to PC printers with parallel ports.

Faster Connections Are you looking for fast Ethernet connections but don't have PCI slots to spare? The \$75 **Fast EtherTX 10/100 Comm Slot II** from Farallon Communications (510/814-5000, www.farallon.com) plugs into the Communications Slot II in the Power Mac 4400, 6400, 6500, and 7200; the Twentieth-Anniversary Mac; and the Performa 6400, 6410, and 6420. Also from Farallon, the \$359 Fast Starlet 10/100 Dual-Speed Hub/8 connects up to eight Ethernet-equipped Macs or peripherals.

If 100-Mbps transfers don't cut it, Publishing Solutions' (330/253-2077, www.pubsol.com) **G-NIC II Gigabit Ethernet** card offers a 1-Gbps transfer speed for \$1,195.

Allegro in the Office Microsoft (425/882-8080, www.microsoft.com) has posted a free update to **Microsoft Office 98** that fixes minor incompatibilities with Mac OS 8.5, including slow menu drop-down, menu color problems, difficulty rendering the euro symbol, and layout and pagination problems when opening some files. You can download it from www.microsoft.com/macoffice/.

—EDITED BY MICHAEL GOWAN

drive batteries, and a charger. Bundled software includes Adobe PhotoDeluxe 2.0 for image editing and Enroute QuickStitch for creating panoramic images. For the first 90 days, Olympus will also offer an extra 8MB SmartMedia card. Olympus says it will still offer the D-600L for \$899.

Point and Shoot The D-400 Zoom offers 1,280-by-960-pixel resolution and a 3× zoom in a compact form factor resembling conventional point-and-shoot cameras. The LCD lets you zoom in on stored images to see details that would otherwise be lost. The price includes an 8MB SmartMedia card and a FlashPath adapter, which lets you transfer images through the Mac's floppy drive. Bundled software includes PhotoDeluxe and QuickStitch. Both cameras connect to Olympus's P300 photo printer.

printing

Color Lasers Move into Graphics

HP, TEKTRONIX UNVEIL
TABLOID PRINTERS

by Stephen Beale

Color laser printers, once used primarily as workgroup devices in offices, are fast moving into the graphic arts, as new models offer improved image quality and other features. The latest entrants are Hewlett-Packard (HP; 800/851-1170, www.hp.com), which is positioning its new Color LaserJet 8500 as a short-run digital press, and Tektronix (503/682-7377, www.tek.com), whose Phaser 780 is targeted at comping and proofing applications. Tektronix has also intro-

News

duced a new solid-ink printer that vastly improves on the image quality of earlier solid-ink models.

HP Presses HP's 600-dpi Color LaserJet 8500 is targeted as a low-cost competitor



HP is challenging color copiers with its new Color LaserJet 8500.

to digital color copiers. It can print 6 color letter-size pages per minute and supports paper sizes of up to 12 by 18.5 inches. Using a Canon laser engine, it boasts a 60,000-page-per-month duty cycle and can handle up to 28-pound paper in its standard 500-sheet input trays and up to 80-pound cover stocks in its 100-sheet multipurpose tray. The base version, aimed at general office applications, sells for \$5,999. For graphics applications, HP recommends the \$8,699 Color LaserJet 8500DN, which features a 7GB hard drive, a 10/100BaseTX print server, an extra 2,000-sheet input tray, and an automatic duplexing unit for two-sided printing. With the hard drive added, the printer can process a page once and then print multiple copies. Resolution-enhancement technology boosts image quality to the equivalent of 2,400 dpi.

Tektronix Goes Tabloid Tektronix's Phaser 780—the company's first tabloid-format color laser printer—is based on the same Fuji/Xerox

engine found in the QMS Magicolor 330 (see *Product Watch, News*, November 1998). The base version, priced at \$4,995, offers 600-dpi color resolution. The \$5,995 Phaser 780GN, aimed at graphics applications, uses resolution-enhancement techniques to boost output to 1,200 dpi. Each model includes a 10BaseT Ethernet connection as standard equipment; you can also purchase an optional 10/100BaseT adapter. It can print on 16- to 32-pound bond paper or on 80- to 120-pound card stocks. Maximum printable area is 13 by 19 inches.

Tektronix has also introduced the Phaser 740, a \$1,995 color laser printer that handles letter-size paper, and the Phaser 740L, a \$1,495 monochrome printer that can be upgraded to color capability by adding a \$550 cartridge.

The company hasn't given up on its solid-ink printing technology, previous versions of which offered fast output speeds and low-cost consumables but mediocre image quality. The new Phaser 840, priced at \$2,495, uses reformulated inks and other advances to offer a vast improvement in image quality. The letter-format printer produces 6 pages per minute in standard color mode and 10 pages per minute in draft mode. Standard resolution is 1,000 dpi, but you can boost this to 1,200 dpi by adding memory. The base version features a 200-sheet paper tray, but you can add up to two 500-sheet trays as options. Other options include automatic duplexing and 100BaseT/10Base2 Ethernet.

All the new Tektronix printers feature interfaces that allow connecting a flatbed scanner, to turn them into color copiers. Many popular scanners are supported; Tektronix provides a list of them on its Web site.

Apple 54xx 64xx Super Mac C500

NEW

World's Only 54/64xx G3 Upgrade

Performa or Power Mac 54/64xx owners are no longer left out in the cold! Transform your computer into G3 machine simply by plugging the Vpower PF G3/240 card into its Level 2 cache slot. Your computer is a big investment. Why let it depreciate when Vpower can keep you at the forefront of Macintosh CPU technology?



PF 240MHz
\$ 499

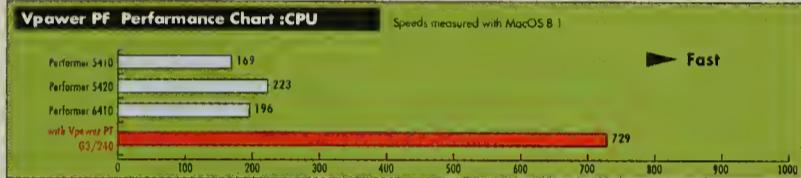

PowerBook 1400

Make your PowerBook work for you with the Vpower PB 1400 G3/233. Scorching speed and extra-low power consumption combine to ensure that you'll be at your most productive, whether at home or on the road.



PB1400 233MHz
\$ 499

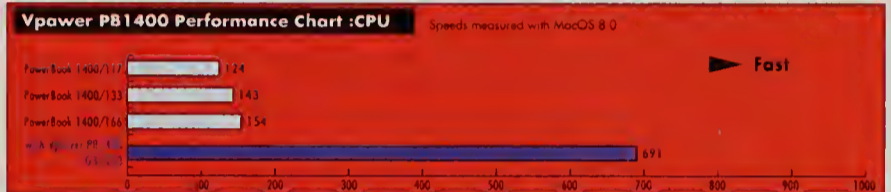

PowerMac 4400 StarMax 3000 & 4000

World's First PM 4400, StarMax 3000/4000 Upgrade

The word is out: Vimage is the industry leader when it comes to producing innovative upgrade solutions for "dead-end" machines. Simple, plug-and-play installation allows you to enjoy all the benefits of a G3 machine in just minutes. There's never been a better time to take your computer to the next level of performance.



300MHz
\$ 899

PM4400 240MHz
\$ 499

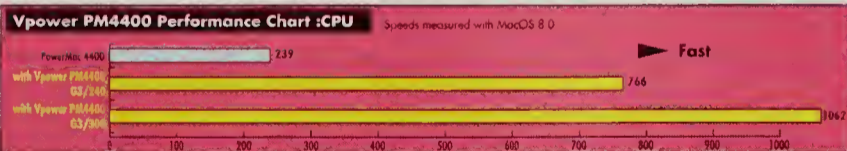

PCI PowerMac

Bring your Power Macintosh into the G3 generation with a Vpower G3 upgrade card, and enjoy the best price-to-performance ratio available on the market!



300MHz/1MB
\$ 798

300MHz/512
\$ 589

233MHz/512
\$ 389

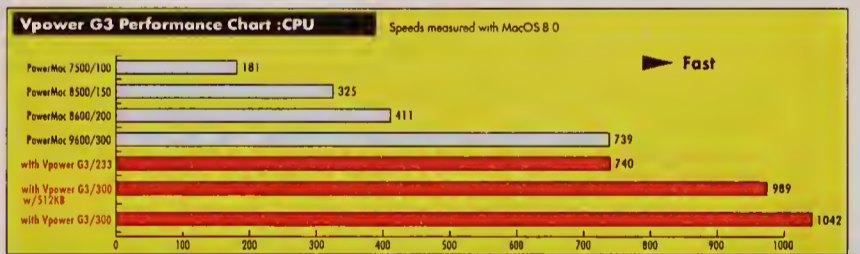

| Product | Compatible Machine | CPU | Cache | Price |
|-----------------------|--|-----------|--------------|--------|
| Vpower G3/300 | Power Mac 7300,7350,7500,7600,8500,8550,8600,9500,9600,9650 UMAX S900,S910 | G3/300MHz | 1MB/150MHz | \$ 798 |
| Vpower G3/233 | Power Mac 7300,7350,7500,7600,8500,8550,8600,9500 UMAX S900,S910 | G3/233MHz | 512KB/117MHz | \$ 389 |
| Vpower PB 1400 G3/233 | Power Book 1400 | G3/233MHz | 512KB/117MHz | \$ 499 |
| Vpower PM 4400 G3/240 | Power Mac 4400 Motorola Star Max 3000,4000 | G3/240MHz | 512KB/120MHz | \$ 499 |
| Vpower PM 4400 G3/300 | Power Mac 4400 Motorola Star Max 3000,4000 | G3/300MHz | 1MB/150MHz | \$ 899 |
| Vpower PF G3/240 | Power Macintosh/Performa 54xx,64xx Super Mac C500 | G3/240MHz | 512KB/120MHz | \$ 499 |

*The PowerPC name and the PowerPC logotype are trademarks of International Business Machines Corporation, used under license therefrom.

To Order Call Toll Free:

1 - 8 7 7 - 4 V I M A G E
8 4 6 2 4 3
Mon-Fri 8AM to 5PM(PST) or FAX:(310)225-3989

Vimage is registered trademark of Interware ca.,Ltd. All other trademarks and, registered trademarks are the property of their respective owners

All major credit cards accepted, no surcharge. Government, Corporate and Educational P.O.s welcome. Vimage products are covered by a two-year limited warranty. Prices are subject to change without notice. Returns require authorization and are subject to a restocking fee. Vpower is a trademark of Vimage. ©1998 Vimage Corporation

For the newest information on Vimage products, check out www.vimagestore.com

Choose 44 at www.macworld.com/getinfo

THE RESOLUTION
IS REMARKABLY CLEAR.
IT'S THE LINE BETWEEN
35MM AND DIGITAL
THAT NOW APPEARS
TO BE BLURRED.

Introducing the end of digital photography as you know it.

The Dimâge EX Zoom 1500. The first digital camera designed to work and perform like your 35mm camera.

The highest image resolution in its class. User-upgradeable



Digita™ operating environment that promotes

in-camera manipulation. A high-speed burst mode

CompactFlash™ CARD



3X Zoom

for continuous 3.5 fps shooting. Unlimited expansion possibilities, including a detachable lens.

All of this with the ease of a point-and-shoot camera. To find out more via photofax, please call 1-800-528-4767, or 201-818-5721 to speak with a customer service representative.

Indeed, the future of photography is clearly upon us.



Megapixel EXpress allows for 7 shots in 2 seconds at full resolution.



{Unretouched image shot with the Dimâge EX Zoom 1500 at 1.5 million pixels.}



Dimâge EX ZOOM 1500

MINOLTA

Only from the mind of Minolta

www.minoltausa.com

© 1998 MINOLTA CORPORATION

Choose 104 at www.macworld.com/getinfo

Reviews

Adobe Illustrator 8.0

VECTOR-DRAWING LEADER

FINALLY DELIVERS

ASK LONGTIME MACINTOSH ARTISTS when Adobe Illustrator started to go downhill, and you'll get a lot of different answers. Many point to Illustrator 7.0, which omitted new features in favor of cross-application harmony. Others considered Illustrator 7.0 a structural recovery from the slipshod additions made to versions 5.0 and 6.0. But most will agree that Illustrator 7.0 amounted to damaged goods.

Refreshingly, Illustrator 8.0 achieves a nearly full recovery. Live blends, enhanced distortion controls, Smart Guides, new Actions and Links palettes, easier navigation, and natural-media brushes make this one of the most feature-rich upgrades to Illustrator in years. Version 7.0 users will delight in the new features and gentle learning curve. Those who stuck with version 6.0 now have reason to grapple with the Photoshop-inspired interface. Illustrator 8.0 is every bit as streamlined as its predecessor, and it's nearly as powerful as Macromedia FreeHand. Together, these two factors make it the best Mac drawing program.

The Ten-Year Blend

Illustrator 88 was the first program to let you blend between two paths to create custom gradations, transitional objects, and morphing effects. In the years since, Adobe has ignored the feature. Version 8.0 finally brings blends into the 1990s.

As in FreeHand, CorelDraw, and



Deneba Canvas, the blends in Illustrator 8.0 are dynamic: if you change the shape, fill, or stroke of one of the anchor paths in a blend, the intermediate paths update automatically. For more diverse color transitions, you can blend among three or more shapes at a time and even blend among shapes that contain predefined gradients. If you begin with two groups of paths, Illustrator can blend between equivalent pairs in the groups (based on stacking order), which is great for creating complex morphs.

Illustrator 8.0 also lets you blend along a curve, which the program calls a *spine*.

You can use the standard path tools to edit the straight spine that Illustrator gives you by default. Or more simply, you can align the blend to a predefined path. After you establish the spine, Illustrator lets you change the orientation of the in-between steps (see "Blends with a Backbone").

Illustrator 8.0's best new features give adept users extra control over object editing. The new Free Transform tool lets you scale, rotate, and slant selected objects all at once. You can also distort objects and achieve perspective effects using the same keyboard toggles available in Photoshop.

REAL PRODUCTS
REAL RATINGS

Reviews you can trust: Macworld rates only final shipping products, not prototypes. What we review is what you can actually buy.

OUTSTANDING: 🍷🍷🍷🍷

VERY GOOD: 🍷🍷🍷

GOOD: 🍷🍷

FLAWED: 🍷

UNACCEPTABLE: 🍷

Illustrator 8.0 makes good on a promise to FreeHand users by letting you select up and down a stack of overlapping paths without having to lock and hide objects. And while you still can't paste one path inside another to get a mask (another common request from FreeHand users), you can now apply fills and strokes directly to masks. To expedite path drawing, you can add and delete points without switching from the pen tool, delete segments with a new eraser tool, and redirect paths just by drawing with the pencil.

My favorite editing feature hails not from FreeHand but from Canvas. Like the Smart Mouse function that Canvas introduced eight years ago, Illustrator 8.0's Smart Guides notify you when your cursor aligns with the center, edge, or anchor point in a stationary object. Although many artists will find the sheer quantity of on-screen notifications overwhelming, those with a penchant for schematic illustrations will take to Smart Guides immediately. The function enables you to select, align, and transform objects with dead-on accuracy.

Closer to Photoshop

If you spend a lot of time trading pixels between Illustrator and Photoshop, then Illustrator 8.0 is indispensable. For the first time ever, you can get a piece of artwork to look the same in Illustrator as it will when rasterized in Photoshop. Inexplicably, Illustrator 8.0 and Photoshop 5.0 approach color management from different directions, but both programs take

Do you cry every time Photoshop flattens your vector artwork? Version 8.0 provides more cause to rejoice. You can export a layered Illustrator file in Photoshop format with all layers intact.

Like Photoshop, Illustrator 8.0 lets you record actions. You can't record mouse-driven operations such as selecting and moving objects, nor can you swap actions between Illustrator and Photoshop, but the interface is identical between the two programs. If you spend much time importing images or rasterizing artwork inside Illustrator, the Links palette is a godsend. Not only does it show every imported graphic in your illustration, but it also lets you update an image file from disk, center the image in the illustration window, and automatically open the image in Photoshop.

To make you feel more at home, Illustrator 8.0 borrows Photoshop's Navigator palette for quick zooms and scrolls. Even better, you can zoom in and out with 0.01 percent accuracy (although scrolling with the hand tool still lurches the page in 20-pixel chunks).

The Whiz-Bang Stuff

The two new features that are likely to attract the most attention are unlikely to have a profound effect on the way you work. First is the Gradient Mesh tool, which lets you add points of color inside a shape. The result is a multipoint gradation, unlike anything available in competing drawing programs. While undoubtedly innovative, the Gradient Mesh tool might inspire as much frustration as creativity. The feature is designed specifically to work with PostScript 3. If you print to a PostScript 1 or 2 device, Illustrator rasterizes the gradient as a 150-dpi JPEG bitmap.

The second new feature is the Brushes palette, which lets you stroke paths with one of four different kinds of effects. The most interesting of these, the Artistic Brush, stretches a collection of objects over the course of a path. Sounds dull, but the effects can be spectacular, from natural-media brushstrokes to swaying graphics (see "Illustrator Becomes Expressive"). If you have ever used MetaCreations' groundbreaking Expression, you've seen artistic brushes in action (see *Reviews*, March 1997).

The Scatter Brush sprays a stream of graphics. But unlike FreeHand's equivalent Graphic Hose, the Scatter Brush doesn't allow you to cycle through differ-

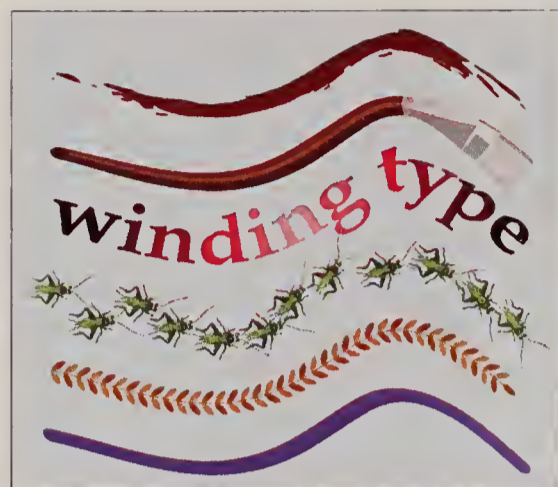

Illustrator Becomes Expressive Artistic brush effects can vary from realistic brushstrokes to stretched artwork to winding text. You can also choose from scatter brushes (the grasshoppers), repeating patterns (the leaves), and calligraphic strokes (the blue line).

ent objects or vary colors as you paint. The last two brushes—Pattern and Calligraphic—are merely repackaged functions that date back to Illustrator 6.0.

Macworld's Buying Advice

If there was ever a must-have upgrade to Adobe Illustrator, this is it. In addition to the major enhancements, version 8.0 offers smoother screen display, organizes path operations in a handy palette, and reinstates the Select Again command. Better still, you can encode EPS files as PostScript 1 or 2 to avoid printing errors.

It would be nice if Illustrator adopted Photoshop's History palette, and FreeHand and CorelDraw still offer some more extras, notably lens effects and enveloping. But Illustrator 8.0 supplies the most essential features and a more streamlined interface. After years of being second best, with version 8.0 Illustrator is again a contender.—DEKE MCCLELLAND

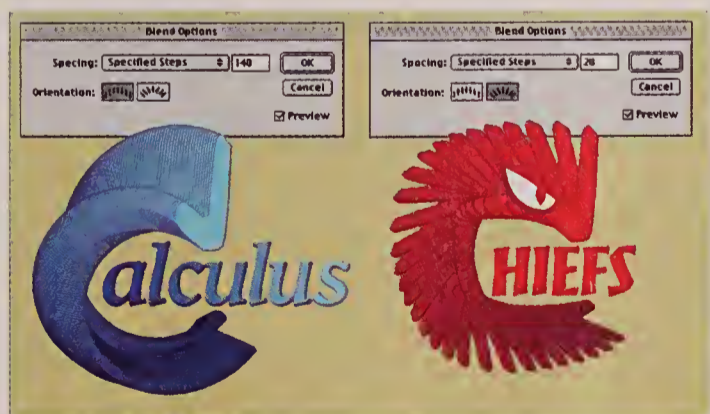

Blends with a Backbone When you're blending along a curve, Illustrator lets you arrange the blended steps vertically (left) or splay them in a fan pattern (right).

their cues from ColorSync. If you go to the trouble of saving RGB and CMYK settings as ICC profiles from Photoshop, you can apply them to Illustrator with appropriately harmonious results.

RATING: **PROS:** Live blends and blends on a curve; paths can be transformed and distorted in one operation; on-the-fly Smart Guides; layered Photoshop files can be exported; naturalistic brush effects. **CONS:** Color-management functions differ from Photoshop's; Gradient Mesh tool is more sizzle than substance. **COMPANY:** Adobe Systems (408/536-6000, www.adobe.com). **COMPANY'S ESTIMATED PRICE:** \$375.

Epson Stylus Color 740

NEW INK-JET IS NOT ALL BUSINESS

EPSON'S NEW FOUR-COLOR INK-jet printer, the Stylus Color 740, may be its most versatile. Aimed at the small-office/home-office market, the Stylus Color 740 offers impressive photo-realistic output, making it a great low-cost alternative to color-laser and dye-sublimation printers. But this printer is not all business: its ease of use, reasonable price, and USB interface make it an ideal choice for iMac users. It also features a serial interface for use with other Macs.

Not New, but Improved

Like the popular Stylus Color 600 and 800 ink-jet printers, the Stylus Color 740 uses Epson's proprietary Micro Piezo printing technology. Unlike ink-jets that use thermal-printing technology, Epson's ink-jets use electrical impulses rather than heat to force ink through print nozzles onto a page. This process minimizes splatter, thus creating cleaner, more consistent dots. With the Stylus Color 740, Epson has modified the Micro Piezo print head to produce smaller and variable-sized dots, resulting in better photo quality and finer detail.

Documents printed with the Stylus Color 740's default settings showed good color reproduction except for minor oversaturation. This was evident in our Adobe Photoshop prints, where we noticed some loss of shadow detail. However, when we experimented with the software settings and printed on high-quality photo paper, photographic images were truly exceptional, with realistic flesh tones and smooth color transitions. The printer also did a good job when printing text on high-grade glossy paper, but type was a bit fuzzy on plain paper.

QuarkXPress and Adobe Illustrator documents printed from the Stylus Color 740 and its six-color counterpart, the Stylus Photo 700 (see "Print Out," *Macworld*, October 1998), looked almost identical. While the 700 edged out the 740 in color accuracy, the 740 excelled in sharpness and detail rendering.

In the Driver's Seat

Epson's software driver for the Stylus Color 740 offers three color-management

options: ColorSync, PhotoEnhance3 (recommended for digital camera prints), and user-defined custom settings. These options are more than adequate for imaging novices. However, professionals may be disappointed with the lack of a PostScript option.

During testing, we found that using



SUZANNE ROADY

Epson's standard ColorSync profile yielded the best results. The driver interface is easily navigable and lends itself to experimentation, so creating the best possible print is not difficult. Also included is a user-friendly maintenance and diagnostic wizard that makes cleaning and adjusting the 740's print heads a cinch.

Speed and Cost

Though ink-jet printers have improved in speed, they still don't compare to color lasers (about four to six pages per minute), and the Stylus Color 740 is no exception. At the highest resolution of 1,440 dpi, Photoshop prints averaged nearly 10 minutes per page, and our QuarkXPress document averaged 7.5 minutes per page. Printing a full-page Word 98 document averaged almost 7 minutes.

For everyday use, the Stylus Color 740's faster 720-dpi setting may be more than adequate, but if you need your documents to look their best, be prepared to wait for them.

The 740 uses two ink cartridges, one black and one color (cyan, magenta, and yellow). Inks are formulated for quick-drying and smudge-free prints. Car-

tridges cost \$29.95 each and will give you about 300 prints, unless you plan to print lots of high-resolution documents, which use more ink.

For the highest-quality prints, it's a good idea to invest in Epson's ink-jet paper, which ranges from 14 cents per page for thin coated paper to \$2.13 per page for glossy photo stock.

Making the Connection

Setting up the 740 is simple: just pop in two ink cartridges, connect the printer to your serial or USB port, and install the drivers. No networking options are available, but you can connect up to three computers—a Mac, an iMac, and a PC—simultaneously to the 740's serial, USB, and parallel ports, respectively. The driver handles just one print job at a time, but it's still a neat feature.

The Stylus Color 740's built-in USB port is a first for ink-jets. This is a great option for iMac users, since compatible printers are scarce, and most that do support USB use a somewhat costly parallel-to-USB adapter cable.

Although some iMac users experienced compatibility problems with early versions of USB drivers from Epson and Apple, the 740 worked trouble-free during our testing, with no crashes in the applications we used. It's a good idea to download and install the latest USB drivers for the Stylus Color 740 and iMac from Epson's and Apple's respective Web sites.

Macworld's Buying Advice

Business professionals who want high-quality color prints without spending thousands of dollars will find the Stylus Color 740 to be a great solution—if they don't mind sacrificing some speed. Home users will appreciate the Stylus Color 740's sharp output as well as its easy-to-use software.—GIL LOYOLA

RATING: **PROS:** High-quality output; built-in serial and USB ports; easy-to-use software.

CONS: Slow. **COMPANY:** Epson America (310/782-0770, www.epson.com). **COMPANY'S ESTIMATED PRICE:** \$279.

Intuos

WEAK SUPPORT MARS AMBITIOUS GRAPHICS TABLET

ON PAPER, WACOM'S INTUOS reads like a computer artist's dream. One tablet supports multiple pointing devices, from mice to pens to simulated airbrushes. All the pointing devices are wireless, making for less clutter and greater mobility. And the mice and pens are ergonomic and inventive, with enough dials and buttons to render the keyboard obsolete.

But in practice, the Intuos is perilously close to the bleeding edge. Several graphics applications, including Adobe Photoshop and MetaCreations Painter, react to Wacom's pressure-sensitive input. But there's little or no support for the

Intuos pen offers a pressure-sensitive nib, an eraser, and a dual-action side switch for double-clicking and other operations. Unlike previous pens, the Intuos device tapers in both directions for a more comfortable feel. And if you buy more than one pen (at \$49.99 each), you can assign each different settings.

Every tablet includes a pen, but only the 9-by-12 and 12-by-18 models include the 4D Mouse (also sold independently for \$69.99), the most versatile and least-supported of the Intuos pointing devices. The 4D Mouse gets its name from the four attributes it records. As with a conventional mouse, the first two are width and height. The third attribute is depth: depending on how you've set up your graphics software, a thumbwheel lets you zoom in and out or scale an image. The fourth attribute is direction: you can use the mouse to rotate objects.

If a graphics program could respond to all this stimuli, you might be able to move an object, scale it with the thumbwheel, and rotate it in one fluid gesture. Alas, no software responds to rotation and only one program, Photoshop, responds to the thumbwheel. After you install Wacom's PhotoZoom plug-in, Photoshop zooms in and out when you move the thumbwheel forward and backward. The thumbwheel conveys pressure, so you can zoom quickly or gradually. Unfortunately, it always magnifies the upper left corner of the image, even if your cursor is positioned elsewhere.

You can change the mouse's incline so the mouse fits snugly in your left or right hand. The thumbwheel also accommodates left- or right-handed use, and the driver software recognizes the change automatically.

Software a Bit Soft

The Intuos driver software (version 4.1.2) is a mixed bag. On the plus side, it provides an extensive array of customization options. Not only can you assign mouse actions, keystrokes, and QuickKeys macros

to any pointing-device button, but you can also create unique settings for different applications. If an application doesn't respond to the 4D Mouse's thumbwheel, you can use the wheel in combination with other buttons, turning your 5-button mouse into a 15-button device.

Also on the plus side, the tablet ships with a Photoshop plug-in that keeps track of the last tool used with each pointing device. If you own the optional Airbrush stylus (a bit expensive at \$99.99), Photoshop automatically selects the airbrush when you touch the stylus to the tablet. Use the pen and you get the paintbrush, use the 4D Mouse and you get the marquee, and so on—very convenient.

On the downside, the software does not support older Wacom tablets. We installed the Intuos on a Mac that also had an older tablet connected to the serial port, and neither tablet worked. The Intuos worked only after we unplugged the serial device. Wacom says that it is working on a fix, but until this problem is solved, previous Wacom customers will have the unpleasant choice of using their old tablets (with older versions of the driver software) or the Intuos, but not both.

Macworld's Buying Advice

Wacom says that Adobe Systems, MetaCreations, Electric Image, Avid Technology, and other vendors are working to support the tablet's more radical functions. In the meantime, the Intuos system delivers about 70 percent of the miraculous functions that Wacom advertises on the outside of the box—good, but not great.

If you're in the market for a pressure-sensitive tablet, you might as well purchase the tablet with the knowledge that third-party support will only improve. But if you already own a Wacom tablet, hold off. No one should ask you to throw away your old hardware to make way for the new, and it will be a while before major graphics programs are revised to support many of the unique Intuos features.—DEKE MCCLELLAND

RATING:  **PROS:** 4D Mouse includes thumbwheel and adjusts to fit predominant hand; Photoshop plug-in remembers last tool used. **CONS:** Many features not yet supported; incompatible with older devices. **COMPANY:** Wacom (360/896-9833, www.wacom.com). **LIST PRICE:** 9-by-12-inch tablet, \$509.99.



KEVIN CANDLAND

Intuos's more radical features, most notably axial rotation (the ability to sense the mouse's pointing direction) and the use of two pointing devices at the same time. In addition, the Intuos pens and tablets are incompatible with older Wacom products. Software support will likely improve, but for the present, the Intuos is a great idea that's still waiting to happen.

Zoom and Swivel

Wacom sells the Intuos tablet in several different sizes. The tablet's active area varies from 4 by 5 inches (\$199.99), for those with small workstations, to 12 by 18 inches (\$819.99). You can select from ADB or serial connections; USB is not an option.

We looked at the \$509.99, 9-by-12-inch tablet, which includes a four-button Intuos pen and the 4D Mouse. Like previous four-button pens from Wacom, the

Norton Utilities for Mac 4.0

UPDATED RECOVERY PACKAGE RELEASED TOO SOON

SYMANTEC'S NORTON UTILITIES for Macintosh (NUM) is the staple tool kit for data search and rescue from deleted files or crashed disks. But version 4.0 is a late arrival. It's the first incarnation of NUM to support HFS+ (known as the Mac OS Extended Format) disks, yet it was released nearly a year after Mac OS 8.1 debuted HFS+. Despite its long gestation period, NUM 4.0 shows clear signs of being hurried out the door.

The Doctor Is In

While the NUM 4.0 collection provides several features, from crash protection to quicker file finding, the package's core consists of Norton Disk Doctor (NDD) and its ability to diagnose and repair disk problems.

NDD 4.0 sports a new look compared with version 3.5, but the shiny new facade eliminates several familiar shortcuts that were in previous versions. For example, you can no longer type a volume's name from the list of mounted volumes to select it, nor can you press the return or enter key to begin examining the disk. These may seem like trivial gripes, but anyone familiar with older versions of the software will find this a roadblock to performing frequent drive checkups.

NDD 4.0 does have a notable usability improvement: for minor problems you can tell the program which files to fix and which ones to leave alone. In the past, fixing such errors was an all-or-nothing proposition. However, NDD 4.0 didn't go far enough with the enhancements. The application can't scan multiple volumes and deal with all the errors at the end. Instead, you're confronted with individual volumes' errors immediately after each one is scanned.

Diagnosis and Repair

When it comes to diagnosis and repair, Norton Disk Doctor 4.0 seems to have shipped prematurely. Shortly after its initial release, user complaints surfaced about NDD's reporting errors on disks formatted with many non-Apple drivers, and the fixes resulted in inaccessible disks.

NDD 4.0 also had problems fixing a directory error that Norton Anti-Virus (NAV) 5.0 can introduce when running under Mac OS 8.1. Symantec has released

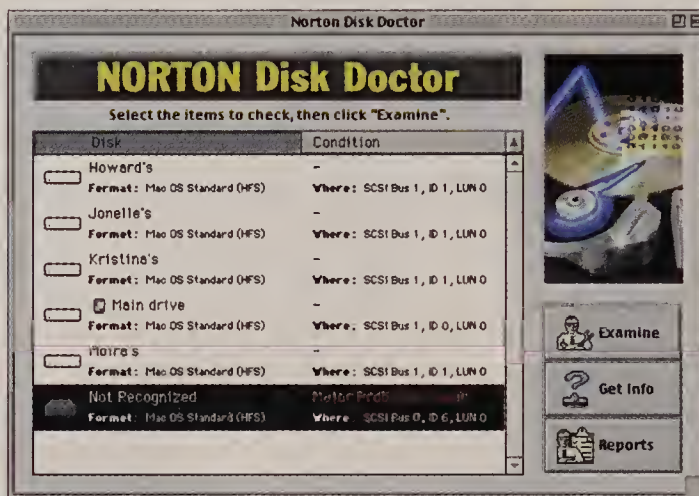

Face-Lift Norton Disk Doctor 4.0's main window is more colorful than its predecessor's but is less easy to use.

an update, NDD 4.01, that fixes the NAV error, as well as reporting errors on disks formatted with FWB's Hard Disk ToolKit 2.5.X. However, it does not address reporting errors on media formatted with other non-Apple drivers.

Symantec should also be faulted for not including the NAV 5.02 patch, which fixes the bug that causes the directory error. The patch doesn't fix the error, but it will prevent NAV from causing directory errors in the future. Sure, you can download the NAV patch from Symantec's Web site, but including the patch on the NUM CD-ROM would have been a simple matter.

Ounces of Prevention

Another revamped part of NUM 4.0 is the multifunction FileSaver extension, which tracks erased files for easier recovery, saves critical disk information at regular intervals, and periodically scans drives for damage. In addition, FileSaver 4.0 also introduces an excellent feature: the ability to scan disks quickly after an improper shutdown or crash.

Unfortunately, FileSaver 4.0 has its problems, too. For starters, performance seriously lags when deleting files. While it's understandable that FileSaver has to do some bookkeeping when deleting files, users may find themselves waiting

while their Trash empties, or while programs, such as Netscape Navigator, remove cache files.

In addition, FileSaver's user interface isn't as configurable as it should be. It's impossible to enable the disk-directory-update feature without also enabling delete tracking. In many cases—for example, on servers—this all-or-nothing choice is undesirable. FileSaver also updates its directory information with every reboot and shutdown. Restart updates are unnecessary in most cases, but there is no way to restrict the updating to shutdowns only.

Speeding Your Disks

NDD may be the core of Norton Utilities, but the package's jewel is Speed Disk 4.0, which improves disk performance by defragmenting files and rearranging data. The updated version now handles HFS+ disks and is somewhat quicker than Speed Disk 3.5. It also remains configurable for

those with a technical bent. Unfortunately, it has slight imperfections: its default settings cause it to scan an entire disk for problems before optimizing. You can also choose write verification, which is more efficient and guarantees that data is written back exactly the way it was before, but we think this should be the default.

One feature missing from Speed Disk is the ability to optimize the directory in addition to all the files; the only comparable process is to back up, reinitialize, and restore a volume, which is far too time-consuming.

Macworld's Buying Advice

Norton Utilities for Macintosh 4.0 suffers from two problems: it was released before it was ready, and many of its user-interface changes were for the worse. While the latter is annoying, it isn't nearly as grave as the loss of confidence caused by teething problems in such a crucial product.—STEPHAN SOMOGYI

RATING: **PROS:** Updated for HFS+; improved Speed Disk performance; PowerPC native. **CONS:** Performance problems; interface has significant rough spots; 680X0 Macs no longer supported. **COMPANY:** Symantec (541/334-6054, www.symantec.com). **LIST PRICE:** \$99.95.

Imagine

impressing your audience with big screen
multimedia presentations

effortless hi-res editing in Photoshop®

the fun of playing the coolest,
most realistic 3D games

working with fully textured 3D models in real time



You can
with ATI graphics accelerator.

Improve your graphics instantly with ATI.



You'll be blown away when you see how adding a graphics accelerator dramatically upgrades the graphics on your Mac. Just plug in any one of our accelerator boards powered by ATI 3D RAGE PRO graphics, and you'll instantly see more colors, higher resolutions and faster, smoother 2D & 3D graphics than you could imagine. Choose the ATI graphics accelerator that suits you best.



ATI XCLAIM VR is the only **5-in-1** accelerator board that gives you 2D, 3D and video acceleration PLUS video capture and video out for big screen presentations or arcade-style gaming. **Now comes with XCLAIM-TV**, the add-on TV tuner card that turns your Macintosh into a high-end TV!

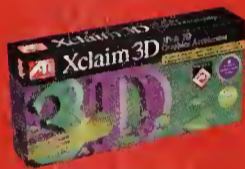

ATI XCLAIM 3D provides **fast 2D and 3D** performance, hi-res true colour graphics and full screen, full motion video. Perfect for design and content creation professionals who typically use resolutions up to 1152x870.



Developed with the professional designer in mind, **ATI NEXUS GA** is a 2D & 3D graphics accelerator featuring ultra-high res true colour and workstation-class 3D performance. **NEXUS GA's New powerful 16MB of memory** supercharges your graphics performance! Ideal for working in resolutions above 1152x870 **up to 1920x1080**.



To find out how you can upgrade your graphics with ATI's award-winning graphics accelerators check out our website at www.atitech.com/ad/macwo.



© Copyright 1998, ATI Technologies Inc. ATI, NEXUS, XCLAIM, MM and RAGE PRO are trademarks and/or registered trademarks of ATI Technologies Inc. All other company and/or product names are trademarks and/or registered trademarks of their respective manufacturers. Features, performance, and specifications may vary by operating environment and are subject to change without notice. Products may not be exactly as shown. 1. At participating resellers.

Now You See It.™

www.atitech.com/ad/macwo



Masking Utilities

THREE PROGRAMS GO FAR BEYOND PHOTOSHOP'S MASKING FUNCTIONS

CREATING MASKS CAN BE ONE of the most difficult parts of altering an image. Fortunately, several programs can help. Two, Extensis Mask Pro 2.0 and Chroma Graphics' EdgeWizard, are Adobe Photoshop plug-ins. The third, Ultimatte KnockOut, is a stand-alone program that works with Photoshop files.

Each program uses a different approach to masking. Mask Pro 2.0 is a general-purpose masking utility, offering a variety of intelligent brushes and tools that let you paint masks into an image. KnockOut shines at creating difficult masks that involve wisps of hair, complex shadows, and translucent elements. EdgeWizard lacks its own masking tools,

usually selects Keep and Drop colors by averaging the pixels beneath the brush. This makes it easier to create complicated masks; without it you would have to make many manual color selections.

Mask Pro can automatically knock out image layer backgrounds, and its pen tool can now automatically detect edges and set control points accordingly. A new, separate EdgeBlender plug-in blends semitransparent pixels with background pixels to reduce halos.

Magic KnockOuts

Mask Pro is powerful, but it still can take a lot of time to mask wisps of hair or translucent objects. That's where KnockOut comes in. You create a mask in KnockOut by using four lasso tools to trace outlines along the boundaries of the area you want to select. The first traces inside the area to be masked; the second, around the outside (see "Hair Today"). Two similar tools let you create inner and outer boundaries for any shadows you want to mask.

KnockOut's Process Image feature then generates a mask, which you can refine using the Syringe or Edge Feather tools. Syringe tools let you inject color into pixels that are being rendered transparent; the Edge Feather tool lets you define edges in areas

where there's little difference between the foreground and background.

KnockOut's results are impressive, but the program cannot soften mask edges, and it lacks tools for manually refining the mask. It's also a memory hog—you need at least five times as much RAM as the maximum image size—and it uses a dongle.

Refining Edges

EdgeWizard's edge-refining tools can automatically eliminate halos and transparency problems. After you create a mask, the plug-in provides a preview of your image and the selection. You can then modify the mask edge in three ways:

QuickEdge applies a two- or three-pixel blur, producing a result similar to feathering. Gaussian Edge applies a Gaussian blur, creating even blends in images that have simple backgrounds. Variable Color Edge, for use with complex selections, analyzes colors along the edge to determine the best way to blend with the background. All three effects can be brushed in or applied globally.

Macworld's Buying Advice

None of these programs is a comprehensive solution, but all three are great complements to the masking tools in Photoshop. Mask Pro is a good one-stop masking tool; it's inexpensive and offers an impressive range of features. KnockOut is missing a few functions and costs nearly twice as much as Mask Pro, but it lets you create difficult masks with a minimum amount of work. EdgeWizard lacks built-in selection tools but does a great job of improving mask edges, especially those composited against complex, multi-colored backgrounds.—BEN LONG



Hair Today Ultimatte KnockOut lets you create complex masks by selecting inner and outer boundaries.

but it lets you refine the edge of an existing selection created in Photoshop or another program (including Chroma Graphics' MagicMask plug-in).

Smart Brushes

Of the three, Mask Pro offers the widest range of masking tools. Similar to Photoshop's QuickMask feature, it lets you select colors to keep and drop using two special eyedroppers. When you paint with Mask Pro's brushes, the plug-in analyzes the colors beneath your brush, compares them with your selected colors, and applies an appropriate level of transparency to the mask.

A new IntelliBrush tool automati-

EdgeWizard

RATING: **PROS:** Strong edge-refining tools; inexpensive. **CONS:** No built-in selection features. **COMPANY:** Chroma Graphics (888/824-7662, www.chromagraphics.com). **COMPANY'S ESTIMATED PRICE:** \$99.95.

Extensis Mask Pro 2.0

RATING: **PROS:** Broad range of masking tools. **CONS:** Creating complex masks takes time. **COMPANY:** Extensis (503/274-2020, www.extensis.com). **COMPANY'S ESTIMATED PRICE:** \$299.95.

Ultimatte KnockOut

RATING: **PROS:** Simplifies creation of difficult masks. **CONS:** Memory-hungry; lacks manual refinement tools; requires hardware lock. **COMPANY:** Ultimatte (818/993-8007, www.ultimatte.com). **COMPANY'S ESTIMATED PRICE:** \$495; before January 1, 1999, \$395.

FREE Guide to Power Protection

Learn How to Choose the Right UPS



- YES!** I want to know how to choose the right UPS for my system. Please send me my FREE Solutions guide.
- NO,** I'm not interested at this time but please add me to your mailing list.

Name: _____

Title: _____ Company: _____

Address: _____

City/Town: _____ State: _____

Zip: _____ Country: _____

Phone: _____

Brand of UPS used? _____ # _____

Brand of Mac used? _____ # _____

Brand of Servers used? _____ # _____

©1998 APC. All Trademarks are the property of their owners. BP3F8CB-US • E-mail: apcinfo@apcc.com • 132 Fairgrounds Road, West Kingston, RI 02892 USA

Just mail or fax this completed coupon
or your FREE Solutions Guide. Better yet,
order it today at the APC Web site!

<http://promo.apcc.com> KEY CODE
(888) 289-APCC x8424 • FAX: (401) 788-2787 1281z

APC®

AMERICAN POWER CONVERSION



NO POSTAGE
NECESSARY
IF MAILED
IN THE
UNITED STATES

BUSINESS REPLY MAIL

FIRST-CLASS MAIL PERMIT NO. 36 WEST KINGSTON, RI

POSTAGE WILL BE PAID BY ADDRESSEE



KEY CODE: i281z
Department: C
132 FAIRGROUNDS ROAD
PO BOX 278
WEST KINGSTON RI 02892-9920

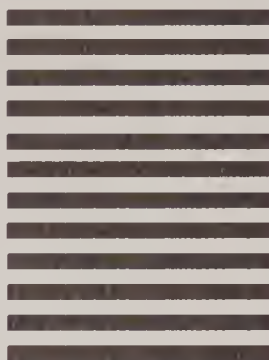

How to Contact APC

Call: (888) 289-APCC, use the extension on the reverse side

Fax: (401) 788-2797

Visit: <http://promo.apcc.com>, use the key code on the reverse side



**What does a digital photographer do
in the middle of a lightning storm?**



**With APC battery backup power,
he gets the picture.
All the time.**

You can find APC power protection products at:

MIDWEST MICRO
1-800-943-5576

COMPUSA
THE COMPUTER SUPERSTORE



MICRO CENTER

Mac WAREHOUSE
1-800-255-6227

APC has won more awards for reliability
than all other UPS vendors combined.



©1998 APC. All Trademarks are the property of their owners. 8P3A8CF-US • (800)347-FAXX PowerFax • E-mail: apcinfo@apcc.com • 132 Fairgrounds Road, West Kingston, RI 02892 USA

Choose 72 at www.macworld.com/getinfo



Real Life

Dear APC: Bartlett Digital photography studio bills by the hour, which means we cannot tolerate avoidable downtime. The surge suppression and battery power of an APC UPS lets us finish the job, as scheduled, even with a temporary power outage.

- Tom Bartlett, central Florida

Fact

According to research by IBM, a typical computer is subject to more than 120 power problems a month. Surge protectors prevent only a fraction of the power problems that cause keyboard lock-ups, system crashes, corrupted data, and worst of all, motherboard burnout. An APC uninterruptible power supply (UPS) with surge suppression and battery back-up protects your software, hardware, and most importantly, your work. APC Back-UPS Pro[®] provides clean, reliable power that lets you function at peak performance, giving you time to shut down during a power outage. Getting the picture? Visit the listed retailers to add APC's Legendary Reliability to your system.

FREE! Guide to Power Protection

Order your FREE 60-page Solutions Guide from the APC Web site today at:

<http://promo.apcc.com> KEY CODE i281z

American Power Conversion
(888) 289-APCC x8424 • FAX: (401) 788-2797

APC[®]
Legendary Reliability

Graphics Accelerators

MACTELL'S VISION3D PRO II LITE WINS THE RACE

NOT LONG AGO, IN A *MACworld* test of 2-D/3-D graphics accelerators, Mactell's Vision3D Pro II 250 turned in some of the best scores but was also much pricier than the other cards (see "Quick on the Draw," August 1998). Since then, Mactell stuffed nearly all that heat into a less expensive package, and it will be tough to beat.

In our search for the fastest pixels in the West, we tested three new 2-D/3-D accelerators: iXMicro's ix3D Mac Rocket and ix3D Pro Rez, and Mactell's Vision3D Pro II Lite. Both iXMicro boards use the company's TwinTurbo 128-3D graphics chip. The \$279 Mac Rocket comes with 4MB of RAM and includes composite-video- and S-Video-out ports. The \$359 Pro Rez comes with 8MB of RAM; video-out ports are a \$59 option. On the Vision3D, Mactell uses Number Nine's Imagine 128 Ticket to Ride chip. We tested the card with 8MB of RAM (\$349); a 4MB version costs \$259.

All of these cards are noteworthy because—unlike game-specific 3-D accelerator cards such as Micro Conversions' Game Wizard (see "Comin' at Ya," elsewhere in this issue)—they accelerate 2-D and 3-D graphics routines, including those used in 3-D modeling programs. Mactell gives a brief nod to game acceleration by implementing portions of Apple's RAVE 3D game-acceleration libraries, but iXMicro ignores game-specific 3-D com-

pletely. None of these cards are intended for primary use as 3-D game accelerators.

With all three cards, installation is a



ix3D Mac Rocket (left), ix3D Pro Rez (middle), and Vision 3D Pro II Lite

piece of cake: just pop open your system and pick an empty PCI slot. The cards all include easy-to-use software installers.

For the most part, the companies' video-control software worked as advertised. iXMicro includes a generous software bundle with each board. Mac Rocket features a full version of Kai's Photo Soap from MetaCreations. Pro Rez includes Photo Soap plus two other MetaCreations packages, Bryce 2 and Expression.

When we put the cards through our test suite, Mactell's Vision3D was the runaway winner. In 2-D tests, it was much faster than the G3 Power Mac's built-in video, and it was slightly faster than the G3 in 3-D tests. The ix3D Pro Rez and

Mac Rocket were only a hair faster than the G3 in 2-D performance. In 3-D tests, the iXMicro boards were slower than an unaccelerated G3.

Macworld's Buying Advice

Of the three boards tested, the Vision3D Pro II Lite wins based on performance, price, and RAVE support (albeit limited). However, it would be unfair to completely dismiss the iXMicro boards. They won't do much to accelerate 3-D graphics, but they will boost 2-D graphics performance, especially on pre-G3 Macs.—CAMERON CROTTY

ix3D Mac Rocket

RATING: **PROS:** Good software bundle; video-out port. **CONS:** Mediocre performance; no game RAVE support. **COMPANY:** iXMicro (408/369-8282, www.ixmicro.com). **COMPANY'S ESTIMATED PRICE:** \$279 (4MB).

ix3D Pro Rez

RATING: **PROS:** Hefty software bundle; video-out option. **CONS:** No game RAVE support; mediocre performance. **COMPANY:** iXMicro (408/369-8282, www.ixmicro.com). **COMPANY'S ESTIMATED PRICE:** \$359 (8MB).

Vision3D Pro II Lite

RATING: **PROS:** Blazing speed; RAVE game support; inexpensive. **CONS:** RAVE support is not complete. **COMPANY:** Mactell (512/323-6000, www.mactell.com). **COMPANY'S ESTIMATED PRICE:** \$349 (8MB).

Macworld
LAB TEST

Faster Pixels?

Best results in red. Reference system in italics. Scrolling scores are relative to those of a Power Macintosh G3/300 with 128MB of RAM, which is assigned a score of 1.00. Frame-rate scores indicate the number of frames per second. MacBench scores are relative to those of a Power Macintosh G3/300 with 64MB of RAM, which is assigned a score of 1,000.

| Video Card | 2-D ACCELERATION | | | 3-D ACCEL. | MACBENCH 5.0 | | |
|---|------------------|--------------------|------------------|-------------------|--------------|---------------------|-------|
| | Word Scroll | QuarkXPress Scroll | Photoshop Scroll | Walker Frame Rate | Graphics | Publishing Graphics | |
| iXMicro ix3D Pro Rez | 1.05 | 1.24 | 1.48 | 29 | 12 | 1,354 | 1,585 |
| iXMicro ix3D Mac Rocket | 1.03 | 1.29 | 1.51 | 29 | 11 | 1,371 | 1,627 |
| Mactell Vision3D Pro II Lite | 3.89 | 1.52 | 2.06 | 34 | 17 | 3,153 | 1,991 |
| Apple Power Macintosh G3/300 built-in video | 1.00 | 1.00 | 1.00 | 39 | 14 | 1,369 | 1,607 |

Longer bars are better.

Behind Our Tests

All cards were tested on a Power Macintosh G3/300 with 128MB of RAM with the display set to 1,152-by-870-pixel resolution. For detailed information on our methodology, see www.macworld.com/tests/.—Macworld Lab testing supervised by Gil Loyola

Mitsubishi Is Changing The Face Of Desktop Monitors.

The Finesse Of Flat: Introducing Mitsubishi's Diamond Pro[®] 900u With The Breakthrough DIAMONDTRON NF[™] CRT.

Mitsubishi's new DIAMONDTRON NF (Natural Flat) CRT technology represents an unprecedented improvement in the way you'll look at monitors from this moment on. The revolutionary, truly flat-faced CRT creates distortion-free, intuitively correct images that are much easier on your eyes. Conventional CRTs produce curves and distortions that are hard on your eyes, increasing fatigue and reducing productivity.

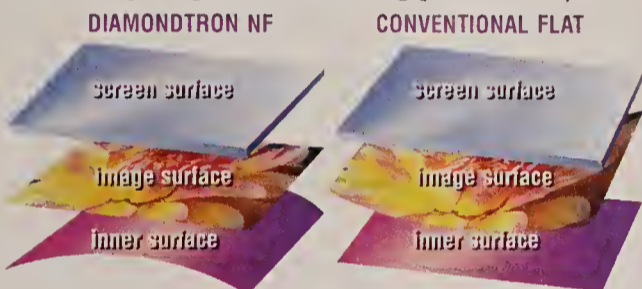

You've come to expect crisp, clear images from Mitsubishi's award-winning DIAMONDTRON monitors, and now the innovative Diamond Pro 900u takes monitor performance to an even higher level. The Diamond Pro 900u delivers consistently accurate image quality – side to side, center to corner. In addition, Mitsubishi's patented CRT manufacturing process makes the Diamond Pro 900u stay brighter up to twice as long as conventional CRT designs. First in a family of DIAMONDTRON NF monitors, the 19-inch (18.0-inch DVI*) Diamond Pro 900u has a maximum resolution of 1600 x 1200/75 Hz. For added flexibility it also features a self-powered USB hub that allows two independent computers to share the display and a single set of USB devices. DIAMONDTRON NF monitors are just flat-out better. For more information contact Mitsubishi Electronics today.

USA: 800-843-2515 • Canada: 800-387-9630
QWIKFAX: 800-937-2094
www.mitsubishi-display.com/pb/mwd/900u

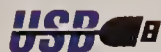

©1998 Mitsubishi Electronics America, Inc. DIAMONDTRON NF is a trademark of Mitsubishi Electric Corporation. Microsoft, Windows and the Windows logo are registered trademarks of Microsoft Corporation. Mac and the Mac OS logo are trademarks of Apple Computer, Inc. *DVI (Diagonal Viewable Image)



 **MITSUBISHI**
DISPLAY PRODUCTS

Innovation On Display_{sm}

Choose 261 at www.macworld.com/getinfo

MacLinkPlus Deluxe

FILE-TRANSLATION UTILITY NO LONGER FREE

WHY BUY THE COW WHEN you can get the milk for free? Although this bit of home-spun wisdom most often pops up in late-night mother-daughter powwows, it has its place in the software business as well. Take DataViz's MacLinkPlus, for instance. At one time, Apple Computer bundled a light version of this file-translation utility with new Macs and system-software packages. To no one's surprise, few Mac users felt com-

This technique remains in MacLinkPlus Deluxe, but the program offers other options as well. For example, you can drag and drop a collection of files and folders into the MacLinkPlus Deluxe window, select the ones you want translated, and click on the Translate button to start the process. Employing this method, you can easily batch-process files of different types. When batch-processing, the program translates files to the type you've chosen in MacLinkPlus's Preferences window. Separate translation preferences can be set for word processing, spreadsheet, database, and graphics files.

As with earlier versions of the program, you can convert files from one type to another using the Document Converter utility. Make a copy of Document Converter, double-click on the copy, determine the kind of conversion to perform (convert files to WordPerfect for Mac, for example), and drag and drop files onto its icon to convert them.

Users with Mac OS 8 or higher can also control-click on a file to summon MacLinkPlus's contextual menu. Using this method, you choose the Mac or PC format you'd like the file translated to—ClarisWorks 4 or the DOS version of WordPerfect, for example—and the MacLinkPlus Deluxe application launches, translates the file, and, on your command, quits when the translation is complete.

So What Else Is New?

The contextual menu hints at some of MacLinkPlus Deluxe's added capabilities. Control-clicking on a file and selecting Recognize from this menu produces a dialog box that identifies the file type as well as offers translation tips. From here you can choose to send the file to MacLinkPlus Deluxe for translation or click on Cancel to dismiss the dialog box.

Another handy feature is the Quick Preview command, also found in the contextual menu. Quick Preview displays a portion of a file's contents—text as well

as graphics—and you can copy the preview to the Clipboard or send the file to MacLinkPlus Deluxe for translation. You can also preview files from within the MacLinkPlus Deluxe application.

Finally—and to be honest, insignificantly—the program expands .sit, MacBinary, Zip, Gzip, TAR, Compact Pro, and Z files and decodes UUencode, MIME, and BinHex files from within the MacLinkPlus Deluxe application window. Aladdin's StuffIt Expander does the same thing, and StuffCM, David Catmull's \$9 shareware contextual-menu plug-in, gives Mac OS 8 users this capability from within Apple's contextual menus. For many users, therefore, this feature may seem superfluous in MacLinkPlus Deluxe.

Not so superfluous, however, is the program's inclusion of translators for the various components of Microsoft Office 98 and Office 97 for Windows. Macintosh users who eschew the Office suite can now easily open these common file types.

Room for Improvement

Not everything about MacLinkPlus Deluxe is sweet, however. Although the utility performs admirably, the interface could be a bit more elegant. For example, when invoking a translation from the contextual menu, users should have the option of translating the file in the background, bypassing the MacLinkPlus Deluxe application.

Background processing of multiple files and folders would likewise be more convenient. And surely there's a more intuitive method for creating Document Converters than requiring users to duplicate the original file.

Macworld's Buying Advice

Inconveniences aside, MacLinkPlus Deluxe is a solid translation utility. If you have an older, *free* version of MacLinkPlus that satisfies your translation needs, the multitude of translation methods and translators may not be compelling enough reasons to upgrade. If, however, you don't already have a copy, MacLinkPlus Deluxe is a worthwhile investment.—CHRISTOPHER BREEN

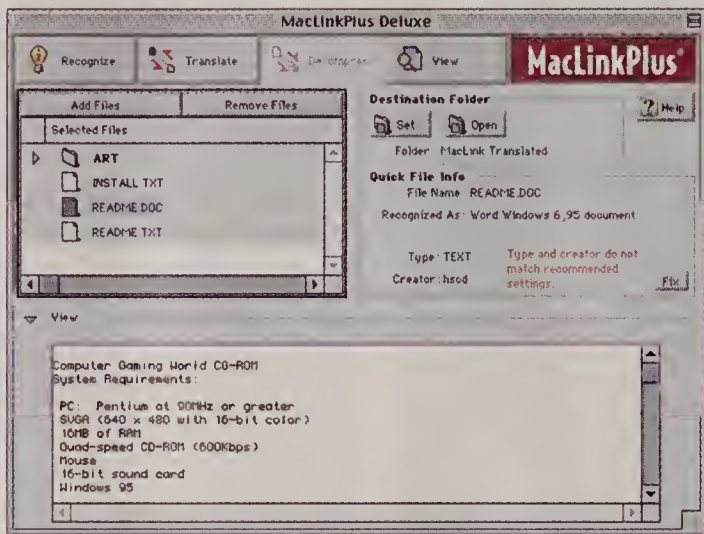

Say What? You can translate and see a preview of unrecognized files with MacLinkPlus Deluxe.

pelled to purchase the full retail version of MacLinkPlus—MacLinkPlus “lite” translated the majority of file types that folks encountered, so why pay for a few extra features and translators?

Well, the milk's no longer free. Apple has stopped including MacLinkPlus, so if you want it, you'll have to pony up for the complete cow: MacLinkPlus Deluxe.

Although the basic functionality of MacLinkPlus remains in the Deluxe version, DataViz has smartened up the interface as well as added a few new translators and features. To begin with, MacLinkPlus is no longer inexorably linked to Apple's Mac OS Easy Open. In earlier versions, you simply double-clicked on an unknown file and Easy Open dutifully translated that file into a readable file type on your hard disk—maintaining most of the document's formatting. In these light versions, MacLinkPlus supplied the translators and Easy Open did the work.

RATING: **PROS:** Capable and comprehensive translation; new interface makes for easier translation. **CONS:** Translation could be less visible. **COMPANY:** DataViz (203/268-0030, www.dataviz.com). **COMPANY'S ESTIMATED PRICE:** \$99.95.

We move the information that moves your world.

adaptec[®]



Upgrade to Adaptec PowerDomain SCSI.

You hate to wait. It's that simple.
So we'll cut to the chase.

Even if you have the fastest Mac available, all loaded up with RAM, native SCSI can be a real bottleneck.

The good news is Adaptec[®] PowerDomain[™] SCSI can boost your disk performance to an amazing 80MB/sec. Goodbye, drinking straw. Hello, Alaska pipeline.

Meanwhile, since newer Macs won't even have native SCSI, you'll need PowerDomain SCSI just to connect to your SCSI peripherals. Of course, since those will also fly a lot faster, you can just smile and let the whole system wait on you.

Visit www.adaptec.com/mac or call 1-800-804-8886 ext. 7756 to order your PowerDomain SCSI.

Revenge is a beautiful thing.

Make your Mac
WAIT ON YOU
for a *change.*

Mac-Disk-Mounting Utilities for PCs

COMPETITION TIGHTENS BETWEEN MACDRIVE AND MACOPENER

FOR MAC USERS, DEALING WITH PC disks is a no-brainer—Mac OS 8.1 and later handle Windows media such as floppy, Jaz, Zip, and SCSI hard disks, using the PC Exchange extension. But your Windows-using colleagues don't have reciprocal support for your media.

Thankfully, there's Windows software that lets PC users read Mac media. One mainstay Mac-disk-mounting utility—DataViz's MacOpener 4.0—has beefed-up support that includes Windows 98 and the HFS+ Mac-disk format in Mac OS 8.1 and 8.5. DataViz has also updated its

ever version of Windows is on their PC.

As you'd expect, MacOpener integrates into the Windows interface, making Mac media available in all standard Open and Save dialog boxes, through the Windows desktop drive icons, and through the Windows Explorer interface to system resources. It also adds a Mac-Format option to the contextual menu when you right-click on a drive icon.

You can also set whether the PC or the Mac portion of dual-format CDs mounts and whether DOS file extensions are added or removed as files are moved from PC to Mac media and back. Once the utility is installed, you can use Mac disks on a PC as if they were native PC disks, and soon you'll forget you have the program. That's how seamless it is.

MacDrive 98 2.1 offers the same integration into Windows. Unlike MacOpener, however, MacDrive does not support Windows 3.1. But it has several nice utilities that MacOpener does not.

For example, it can identify Mac files' creator and file types, which is handy when you are trying to update the extension maps in Mac-disk-mounting software, in cross-platform networking soft-

ware, or in the Mac OS's PC Exchange. Another handy utility lets you copy Mac disks from your PC's drives.

On Media4's Web site you'll find several utilities that remap special symbols between Mac and PC files to correspond to the different locations where these symbols occur in Mac and PC font files.

Except for these small differences, the two programs are the same, and the nominal price difference doesn't argue for one over the other. Basically, the two programs are incredibly similar: The extra utilities in MacDrive give you more options, but if you use Windows 3.1, you should go with MacOpener.

Conversions Plus

The newest version of DataViz's Conversions Plus is not a major upgrade. It adds

Microsoft Office 98 for Mac file formats to its translation list of word processing, database, spreadsheet, and graphics formats; integrates into Microsoft's Outlook 98 e-mail manager; and has the nifty Attachment Opener, which decodes various compression formats (MIME, UUencode, and BinHex) popular for Web and e-mail files.

However, most people on both platforms are using Microsoft Office, and most modern programs import from and export to competing formats. Programs with Mac and PC versions almost always read each other's files without translation.

If you deal with people who use outdated formats such as WordStar, you'll want Conversions Plus, but otherwise, consider if you can handle translations with your current programs' import/export options.

The Attachment Opener utility may be appealing, since there are still occasional mismatches between browsers, mail clients, and compression utilities (such as Stuffit and WinZip) that require manual decoding of file attachments.

Macworld's Buying Advice

You can't go wrong with MacDrive or MacOpener, but avoid Conversions Plus unless you really need it.—GALEN GRUMAN

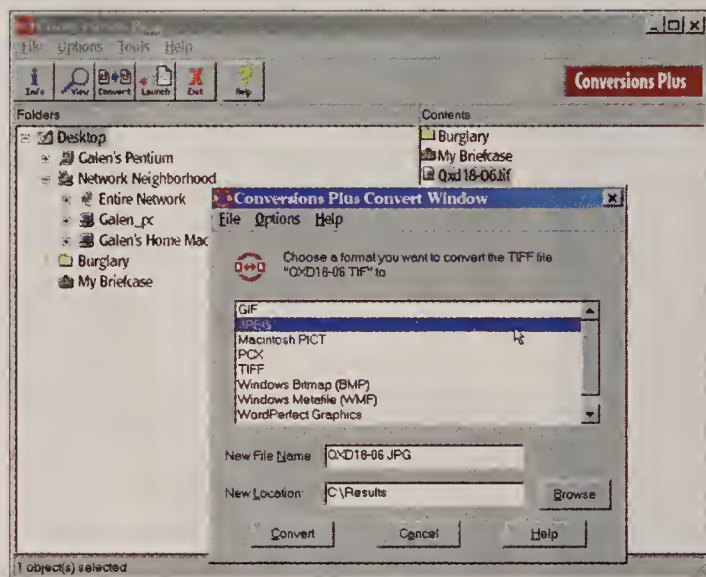

Single-Source Translation Conversions Plus gives users one place to do translations among common file types.

Conversions Plus file-format translation utility—which includes MacOpener—to support Microsoft Office 98 files and to allow conversion of attachments in Microsoft Outlook 98's e-mail program.

And MacDrive (★★★★½; \$75 list price; *Reviews*, April 1998), from Media4 Productions (515/225-7409, www.media4.com), has also been updated. The changes between the 2.01 version reviewed and the current version (2.1) are essentially bug-fixes.

Disk Mounters Compared

The changes in the new release of MacOpener, 4.0, are very focused: Windows 98 and Mac OS HFS+ compatibility. Otherwise, the disk mounter is the same as in version 3.0. That's not bad, since MacOpener does everything most users will need, what-

Conversions Plus 4.5

RATING: ★★★★★ **PROS:** Integrates into Windows 3.1, 95, 98, and NT 4 menus and dialog boxes; supports HFS+ from Mac OS 8.1 and 8.5; offers handy file-format translation for files and Web attachments. **CONS:** File conversion is not needed for most modern formats. **COMPANY:** DataViz (203/268-0030, www.dataviz.com). **COMPANY'S ESTIMATED PRICE:** \$99.

MacOpener 4.0

RATING: ★★★★★½ **PROS:** Integrates into Windows 3.1, 95, 98, and NT 4 menus and dialog boxes; supports HFS+ from Mac OS 8.1 and 8.5. **CONS:** Offers nothing beyond the essentials. **COMPANY:** DataViz (203/268-0030, www.dataviz.com). **COMPANY'S ESTIMATED PRICE:** \$60.

IT'S SIMPLE. IT'S USER-FRIENDLY.
COULD IT BE ANY MORE MAC COMPATIBLE?



Address book



Date book



Memo pad



To do list

Now the Palm III™ connected organizer and the Macintosh are even more compatible, thanks to the Palm™ MacPac. It's designed specifically for the Mac OS and includes new Palm™ Desktop software, based on award-winning Claris Organizer. And our enhanced HotSync® software makes it even easier to exchange information with your Mac. What's more, e-mail, expense, and many other third party applications are now available. To learn more, visit www.palm.com or call 1-800-861-2529.

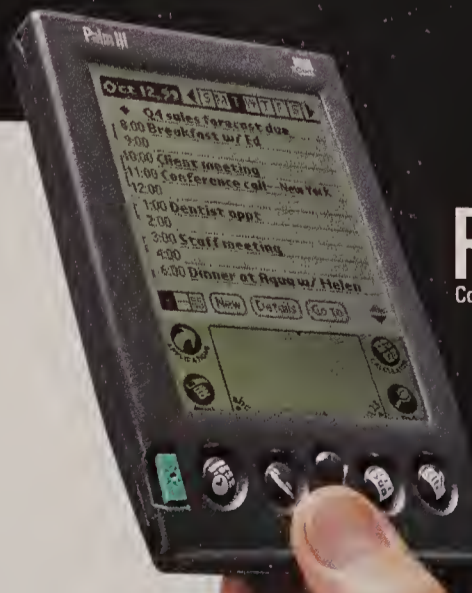

Palm III
Connected Organizer

Palm™ MacPac required for Macintosh connectivity, sold separately for \$14.95 © 1998 3Com Corporation. 3Com, the 3Com logo, Palm Computing, Graffiti and HotSync are registered trademarks and Palm III, Palm OS, Palm, Palm Computing platform logo, and the Palm III logo are trademarks of Palm Computing, Inc. or 3Com Corporation. Other products and brand names may be trademarks or registered trademarks of their respective owners. USB support not currently included, see www.palm.com for updates.

3Com® More connected.™

LinkUPPP Turbo 3.0

DOUBLE THE SPEED WITH TWO MODEMS

THE RECENT DEVELOPMENT OF Multilink Point-to-Point Protocol (MLPPP) created a flurry of network adapters that increase bandwidth by letting you connect two or more modems in parallel. But these devices cost a few hundred dollars, plus the price of extra modems. Thankfully, FCR's LinkUPPP Turbo 3.0.2 can do the same thing without the extra cost. This software kit achieves up to 112-Kbps throughput by letting you combine the speed of two 56-Kbps modems.

LinkUPPP Turbo installs easily with a downloadable installer application that places the LinkUPPP control panel, an MLPPP extension, and electronic documentation on your hard disk. The installer thoughtfully removes any prior PPP dialers to prevent troublesome interactions. LinkUPPP Turbo inherits the extensive functionality of its previous incarnation: AppleTalk and TCP/IP support, a huge library of modem and login scripts (including ones for iMacs and 56-Kbps modems), and detailed diagnostics. Its elegant user interface simplifies basic configuration while providing access to advanced features, such as autodialing, redial on busy,

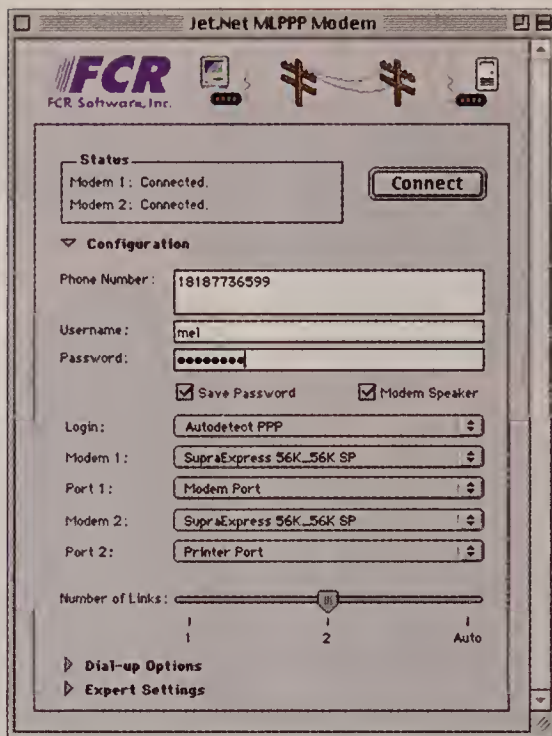

Double Your Fun LinkUPPP Turbo includes dual-modem support, letting you combine the bandwidth of two modems.

and dynamic bandwidth expansion. Once a connection is running, you can open various status windows to display throughput and diagnostic information.

Before you connect to an Internet service provider or other remote-access server that supports MLPPP, make sure the

remote service to which you connect has MLPPP enabled. LinkUPPP can dial up both connections immediately, or initially dial up one and add the second only if you need to speed remote access.

Unlike some stand-alone multimodem implementations, such as Ramp Networks' WebRamp M3I Plus, LinkUPPP Turbo doesn't depend on multiple TCP/IP data streams to achieve its rated 112-Kbps throughput. In tests, LinkUPPP Turbo hit this number consistently even with individual file transfers.

Macworld's Buying Advice LinkUPPP Turbo's elegant user interface, extensive modem support, AppleTalk support, detailed diagnostics, and dual-modem capability make it the king of native Macintosh remote access. And AppleTalk support means that you can access all of your home network's resources remotely. If you need to connect a single Mac to your network or the Internet at higher-than-modem speeds, LinkUPPP Turbo is your best bet.—MEL BECKMAN

RATING: ★★★★★ **PROS:** Bonds two modem connections; inexpensive; AppleTalk support; extensive diagnostics. **CONS:** None. **COMPANY:** FCR Software (617/494-1300, www.fcr.com). **LIST PRICE:** \$59 (multiuser pricing available).

VivoActive VideoNow 3.0

FRIENDLY, INEXPENSIVE UTILITY CREATES STREAMING-MEDIA FILES

WHEN REALNETWORKS ACQUIRED Vivo Software, in March 1998, it looked like the latter's VivoActive streaming-media technology might go the way of the Betamax. Fortunately, RealNetworks is continuing to develop compression tools for the VivoActive format. The latest is VivoActive VideoNow 3.0. Like its predecessor, VivoActive Producer 2.0, VideoNow 3.0 is a breeze to use: select the QuickTime movie you want to convert to VivoActive format, specify the target delivery speed, and click on a button.

The VivoActive streaming-media technology isn't as sophisticated as RealNetworks' RealMedia or Microsoft's NetShow, but it has the advantage of simplicity. Rather than grappling with dedicated server software, you can dish out VivoActive clips by using the same HTTP server that handles your Web pages. You can also do this with RealMedia clips, but VivoActive's superior HTTP streaming uses network bandwidth more efficiently.

VideoNow 3.0 provides a wide variety of presets for common connection speeds

and quality settings (see "Video Crunch"). You can customize these presets and create new ones, and you can apply multiple presets (for example, to create clips for different connection speeds) to a single movie.

VideoNow 3.0 isn't just a one-trick

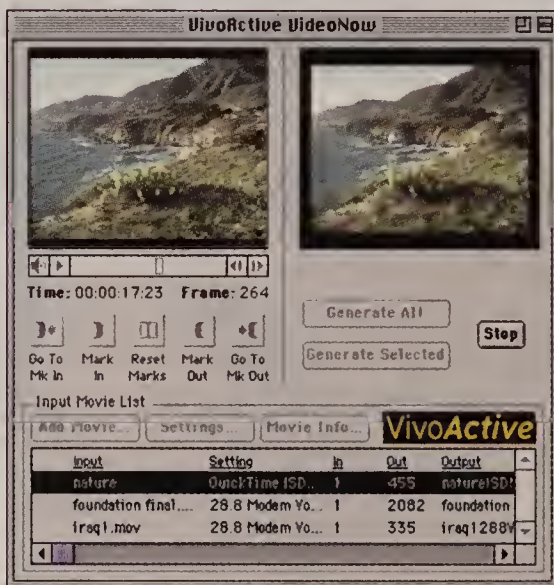

Video Crunch VideoNow's simple, single-window interface displays before and after views of a movie as it's being compressed.

pony. It's the only Mac program that can compress clips for the ASF format, used by NetShow. It can also create QuickTime 3 reference movies, one of which can refer to multiple movie files, each compressed for a specific connection speed.

But VideoNow 3.0 doesn't support reference movies as well as Terran Interactive's Media Cleaner Pro 3.0 does (see *Reviews*, November 1998). You can't, for example, specify that one alternative movie plays on Macs while another plays on Windows. VideoNow also lacks Media Cleaner Pro's broad array of quality-optimizing features. But VideoNow costs just \$49, versus Media Cleaner Pro's \$359.

Macworld's Buying Advice VivoActive doesn't have the quality or bells and whistles of RealMedia and NetShow, but it's refreshingly straightforward. VideoNow's low price and its support for NetShow and QuickTime 3 reference movies make it a versatile tool for producing basic streaming-audio and -video content.—JIM HEID

RATING: ★★★½ **PROS:** Inexpensive; straightforward. **CONS:** Quality inferior to that of RealMedia and NetShow; reference-movie support is limited. **COMPANY:** RealNetworks (206/674-2700, www.real.com). **LIST PRICE:** \$49.

It is a good day to die.



STAR TREK THE NEXT GENERATION®

KLINGON HONOR GUARD™



Plunge into the heart of the Klingon Empire in this fast-paced 3D shooter based on the ground-breaking Unreal engine. Honorless forces have conspired to throw the High Council into mayhem, and your skill will be tested to the limits by the relentless challenges and brutal foes that await you. Fulfill your blood oath as an elite member of the Klingon Honor Guard and strike to the root of the dark conspiracy. Blood is the price of dishonor. Sharpen your Bat'leth, it is your duty to exact this price for the glory of the Klingon Empire.

Duty

Honor

Glory

MICROPROSE
www.microprose.com
Westlake
INTERACTIVE



Available soon at your local retailer, or visit the GT Interactive online store:
<http://www.gtstore.com> or call 800/229-2714

©1998 MicroProse, Inc. All Rights Reserved. STAR TREK THE NEXT GENERATION® & © 1998 Paramount Pictures. MICROPROSE is a registered trademark and *Klingon Honor Guard* is a trademark of MicroProse, Inc. or its affiliated companies. All Rights Reserved. Distributed and published by MacSoft, an affiliate of GT Interactive Software Corp. All other trademarks are the property of their respective companies. Many Klingons died honorably during the making of this game.

Choose 30 at www.macworld.com/getinfo

MacSoft®
An affiliate of GT Interactive Software Corp.
www.wizworks.com/macsoft/

N O W

Y O U

C A N

C O D E



Turn your ideas into applications

Whether its a small utility, a large application or the next great game, REALbasic lets you turn it into a reality. REALbasic is easy for beginners yet powerful enough for professional developers.

Download a FREE trial version at
www.realbasic.com or call
 (512) 292-9988 for more information

REALbasic™

REALbasic is a trademark of REAL Software, Inc.

See Us at Macworld Expo in
 San Francisco Booth #1647

Vpower PM 4400 G3/240

GAIN SPEED FROM EASY UPGRADE

WHEN APPLE COMPUTER waved good-bye to the clones, it left behind a legacy of Macs with sketchy upgrade options. Now owners of the Power Macintosh 4400; the Motorola StarMax series; and clones from APS, Mactell, and PowerTools can beef up their machines with a Vimage Vpower PM 4400 G3/240 upgrade card.



GIBSON

The Vpower PM4400 G3/240, a 240MHz CPU with a 512K Level 2 cache, installs in the cache slot of the 4400, replacing any existing cache module. Since these Macs represent a generation of machines that didn't house the CPU on a daughter-card, Vimage created an upgrade card for the cache slot. Unlike other G3 upgrade cards, the Vimage card doesn't have any software controls for tweaking the cache-to-bus ratio. The card also lacks hardware switches—it operates at a fixed frequency.

Stability and Simplicity

Macworld Lab tested the Vpower card in a Power Mac 4400, and based on the results, other models using Apple's Tanzania architecture should work equally well (see "Vpower Resurrects Old Macs"). MacBench 5.0 and SpeedMark tests indicated a twofold improvement over running without the card. But the card's slower, 40MHz bus somewhat hampered performance against that of the 66MHz system bus of the 233MHz G3 Power Mac.

The real speed gain was confirmed in informal real-world tests. In Adobe Photoshop, the upgraded Mac gained about 25 percent over the unaccelerated machine and was up to 63 percent faster in some image-processing tasks. For more speed, check out the \$999, 300MHz version of the Vpower card, with a 1MB Level 2 cache.

Macworld's Buying Advice

The Vpower PM4400 is a stable upgrade. Keep in mind, though, Apple's statement that third-party upgrade cards will not be officially supported under Mac OS X. It will be the card manufacturers' responsibility to provide any necessary fixes.—JEFFY MILSTEAD

RATING: **PROS:** Easy installation; hefty speed boost. **CONS:** Slower than the 233MHz Power Mac G3. **COMPANY:** Vimage (310/225-3979, www.vimagestore.com). **LIST PRICE:** \$549.

Macworld
LAB TEST

Vpower Resurrects Old Macs

Best results in red. Reference systems in italics. SpeedMark scores are relative to that of a Power Mac 7100/80, which is assigned a score of 1.0. MacBench 5.0 scores are relative to those of a Power Mac G3/300, which is assigned a score of 1,000 in each test.

| | SPEEDMARK | | MACBENCH 5.0 | | |
|---|---------------------|--|--------------|------|----------|
| | Overall Performance | | Processor | Disk | Graphics |
| Apple Power Macintosh 4400 with Vpower PM 4400 G3/240 | 3.8 | | 698 | 618 | 949 |
| Apple Power Macintosh 4400 | 2.0 | | 337 | 521 | 681 |
| Apple Power Macintosh G3/233 | 4.0 | | 732 | 611 | 1,291 |

Longer bars are better.

Behind Our Tests

The tested systems, running Mac OS 8.1, were set to 832-by-624-pixel resolution and had a 512K system disk cache. The systems had 64MB of RAM, except the Power Macintosh G3/233, which had 32MB of RAM. For SpeedMark tests, displays were set to 16-bit color. For MacBench testing, all systems were set to 24-bit color.—Macworld Lab testing supervised by Kristina DeNike

4D MOUSE

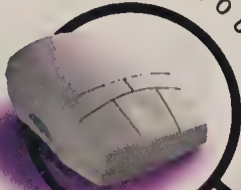

LENS CURSOR



AIRBRUSH



PROGRAMMABLE PENS



Creative freedom
MAKES A
comeback.

Unfortunately, the standard mouse was never designed for creative purposes. Set yourself free with the Intuos graphics tablet system from Wacom. With its newly designed pen and tablet, as well as the new 4D Mouse and digital airbrush, it really puts creativity back in the hands of the creator. For example, with 1,024 levels of pressure sensitivity, you can control color, exposure, line width and even opacity with the slightest tip pressure. Even better, Intuos comes with key ergonomic improvements, Tool ID™, Painter Classic™ and other cool stuff. Go find out more at www.wacom.com or 800.922.2585. And enjoy your freedom.

WACOM *intuos*
INTELLIGENT GRAPHICS TABLET SYSTEM™

©1998 Wacom Technology Corporation. Wacom is a registered trademark and Intuos and Tool ID are trademarks of Wacom Company Ltd. All rights reserved. Wacom products are available at Comp USA, Computer City, Microcenter and other fine retail and mail order resellers nationwide.

Choose 84 at www.macworld.com/getinfo

Conquer Disk Damage



Introducing DiskWarrior™,
a revolutionary new way
to restore damaged disks!

DiskWarrior is a revolutionary new utility that combats disk damage. It quickly rebuilds, recovers and optimizes your HFS and HFS Plus disk directories, eliminating all directory errors and recovering lost files. Other utilities attempt to repair disks by patching the damage. Patching can result in more damage and permanent loss of files.

100% Recovery Assurance

Only DiskWarrior builds a new optimized directory using data recovered from the damaged directory. You have 100% assurance that DiskWarrior will always restore your disks and recover your files when directory damage is your enemy.* You'll also have 100% confidence that you're getting the desired results. DiskWarrior's exclusive Preview ability lets you preview the restoration. You can examine your damaged disk in the Finder as it will appear after the directory is restored but before any changes are made to your disk.

Routine Maintenance

DiskWarrior is your first line of defense against unseen disk damage. Running DiskWarrior regularly prevents small unseen problems from becoming large ones by keeping your directories error free. You'll also keep your directories optimized to speed up overall disk performance.

©1998 Alsoft, Inc. PO Box 927, Spring, Texas 77383-0927 USA. 281-353-4090 or fax 281-353-9868. DiskWarrior is a trademark of Alsoft, Inc. *Visit our web site or call for requirements. DiskWarrior is not a magician. No utility can restore directories that have been written over.



THE UTILITY COMPANY

ALSOFT

www.alsoft.com 800-257-6381

Choose 140 at www.macworld.com/getinfo

ElectricImage 2.8

INDUSTRIAL-STRENGTH 3-D GRAPHICS
TOOL, EVEN WITHOUT MODELER

WITH A VAST NUMBER OF major motion-picture and broadcast special effects to its credit, ElectricImage has established itself as the state-of-the-art 3-D graphics program for the Mac—even if it does cost more than most CPUs. The latest version still lacks an integrated modeler, but with version 2.8's

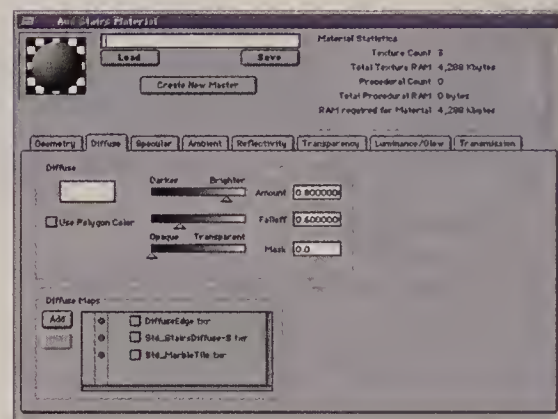

New in Your Face ElectricImage 2.8 has a significantly overhauled interface, including a much improved Materials Editor.

new features and tweaks of existing ones, ElectricImage remains the best Mac-based rendering and animation tool for production professionals.

Relief in Changes

The ElectricImage interface's many improvements will be welcome to long-time users. For example, the new Selection Set feature lets you group subsets of object parameters, a critical addition for managing scenes with large numbers of objects and textures. Grouped objects can now have *bones* that allow you to deform them, an important feature for making characters walk and move.

You get two flavors of morphing. One requires the source and target objects to have the identical polygon and vertex count. The more-powerful and -flexible multitarget polygon morphing lets you select subgroups of polygons for morphing, a crucial feature for facial animation.

ElectricImage's animation controls still define the standard for Mac-based 3-D graphics and include a new Function Curve Editor, which delivers extremely fine control over advanced keyframe and animation parameters.

Texture handling has received per-

haps the most attention in this upgrade, bringing it up to truly professional standards. You can apply an unlimited number of texture maps per object; advanced texture caching handles memory overflows that would plague lesser rendering environments. Displacement mapping allows an imported gray-scale image to distort an object's shape, yielding amazing special effects. For example, you can animate the displacement amount to have one shape "grow" out of another. (Displacement mapping is different from bump mapping, which adds the appearance of surface deformations without changing the object's geometry.)

The texture-map interface has been overhauled and is much more straightforward than in previous versions. New procedural textures—such as woods, stones, and rust—are a welcome addition, but they still pale in comparison with those found in MetaCreations' Bryce 3D. However, ElectricImage cannot preview texture maps in its working windows. The program does not support OpenGL or QuickDraw 3D, either of which would permit limited texture previews.

Rendering has been speeded up, although by how much varies, depending on polygon counts, volumetric lights, and texture settings. A new depth-of-field capability adds to realism by automatically applying specific levels of blurring as objects recede from the camera.

ElectricImage is available in separate editions for film and broadcast production. The broadcast edition is limited to supporting video resolutions; the film version supports the higher resolutions used in motion pictures.

Macworld's Buying Advice

If you bill serious dollars for rendering and animation work, ElectricImage can pay for itself in a professional production environment. It's not for the casual 3-D artist, but those who need the power of ElectricImage know who they are and will definitely want this upgrade.—DAVID BIEDNY

RATING:  **PROS:** Fast, high-quality rendering; excellent texture controls; robust file-format support. **CONS:** No modeler; no texture-map previews in scene views; high price. **COMPANY:** Electric Image (626/577-1627, www.electricimage.com). **COMPANY'S ESTIMATED PRICE:** Broadcast version, \$2,995; film version, \$7,495.

Frontier 5.1

CONTENT-MANAGEMENT AND SCRIPTING TOOL STILL TEETHING

USERLAND SOFTWARE'S FRONTIER started out as a scripting language, an alternative to AppleScript. Now, in version 5.1.4, Frontier has been reborn as a Web-content-management system. Frontier still houses the scripting language but also includes a lightweight Web server and numerous other features that can make it a Web-content repository, Web-site development environment, or Web-server back end.

It Slices, It Dices

For those familiar with previous versions of Frontier, version 5.1.4 is a relatively straightforward upgrade. But newcomers may find Frontier's capabilities both powerful and unwieldy.

At the core of Frontier 5.1.4 are the object-database engine and the main database file, Frontier.root. Because storing all data in a single database can lead to corruption, Frontier 5.1.4 introduces the capacity for guest databases, allowing ancillary content databases separate from Frontier.root. This welcome addition drastically reduces the likelihood of crippling database mishaps.

Web Identity

Frontier's new Web-centric identity comes from the concatenation of the system's different capabilities. The database engine stores and delivers Web-site content, and the scripting language drives the Web-related features. Once a site is ready to go live, Frontier "renders" it, saving the pages that make up the site into static files. Alternatively, Frontier's integrated lightweight Web server can deliver some or all pages—often generated on the fly via UserTalk scripts—dynamically. Be warned, though: the built-in server is not intended for heavy loads.

Since many of Frontier 5.1.4's Web features are implemented as scripts and attendant data, referred to as "suites," it's easy to change and customize much of Frontier's functionality. Both UserLand and users can modify standard behaviors or post updates.

No Compass

Frontier 5.1.4's most prominent fault is a lack of coherent documentation. You simply download the product from UserLand's site. The software is accompanied only by a basic tutorial that refers to online resources for further information. Although there is, indeed, a great deal of information available online, it's woefully disorganized. For a new user, this can be a major setback.

If Frontier 5.1.4 were still a freeware product, many of these gripes wouldn't be an issue; the Linux community is a perfect

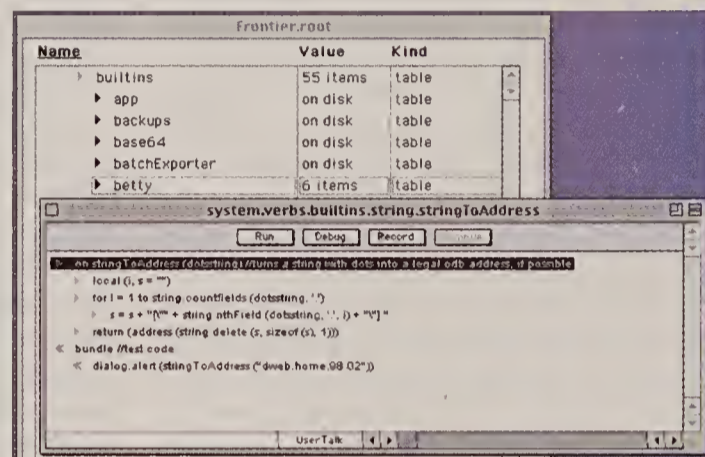



Table Talk Frontier's interface displays all its data—formatted text, UserTalk scripts, and stored Web pages—as a collection of tables and hierarchical outlines.

example of how an organic support structure works with ad hoc documentation.

Frontier's abrupt transition from freeware to commercial software—with little change other than bug-fixes—appears premature. Currently, Frontier's price tags aren't justified by the quality of the initial commercial release or by the resources and support UserLand provides.

Macworld's Buying Advice

Frontier 5.1.4 provides an undeniably unique and powerful set of features. However, the transition from freeware to a commercial product was too hasty; new users are more likely to feel overwhelmed by the product's breadth and depth than invited in to explore.—STEPHAN SOMOGYI

RATING:  **PROS:** Comprehensive, highly integrated set of Web capabilities; ongoing, aggressive development. **CONS:** E-mail-based support only; insufficient documentation; high price. **COMPANY:** UserLand Software (fax only: 650/685-0867, www.userland.com). **LIST PRICE:** Non-commercial license, \$299 per year; commercial license, \$899 per year.

Profiler 1.1

LOW-COST PROFILING TOOL DELIVERS

ONE OF THE MAIN ROADBLOCKS to the widespread adoption of ColorSync and other ICC (International Color Consortium)-compatible color-management systems is the difficulty and expense of building profiles for output devices. Delta E's affordable Profiler 1.1 may help break that logjam. Other low-cost tools exist, but they require you to measure hundreds or thousands of color patches in order to build a profile. Profiler is special in that the program requires only 18 measurements, making it usable with relatively inexpensive handheld instruments.

The profiling process is quite simple: with all color management turned off, print the calibration target containing the 18 patches. Then measure the patches—the software provides audible feedback when each measurement is complete and automatically advances to the next patch for measurement. Once the measurements are complete, Profiler prompts you to save a Delta E profile, which the program uses as the basis for creating ColorSync profiles and Adobe Photoshop separation tables. To build the full set of profiles, simply click on

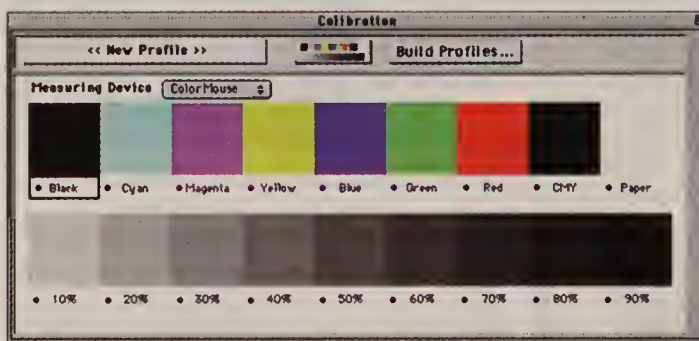

Less to Add Delta E's Profiler 1.1 sets itself apart by requiring fewer measurements than other low-cost device profilers.

the Build Profiles button—the rest is automatic. On a 300MHz Power Mac G3, Profiler takes around 4 minutes to build all the profiles. So the entire process, from printing the target to producing the profiles, can be accomplished in around 15 minutes.

When we printed to a Minolta CF-900 color laser copier and a Hewlett-Packard DeskJet 697C ink-jet printer—which use halftone dots—the profiles produced good results. But the results were subpar when we tested profiles on two continuous-tone printers, the NewGen Chromax Pro and the Fuji Pictography 4000. This isn't a crippling constraint, by any means, since most printers used in graphic arts are based on halftone processes.

Profiler lets you open images and view printer simulations. The Blend control lets

you view the different rendering intents built into the profiles. But although you can view intermediate stages among the intents, you can't change what gets built into the profile.

The Gray Adjustment feature lets you shift the hue of your neutral tints by a variable amount. It's hard to use, because you can't preview the effect on screen—it shows up only in the final print. We recommend

using this sparingly, if at all.

Macworld's Buying Advice Profiler 1.1 is probably best suited to working with color copiers, which are notorious for drifting. It's faster to reprofile most color copiers with Profiler than it is to relinearize them with the vendor-supplied calibration tools. Profiler also seems to work well with ink-jet printers. Despite its limitations, Profiler is an affordable, stable product that shows a great deal of promise for the future.—BRUCE FRASER

RATING: ★★★ **PROS:** Inexpensive; easy to use; supports most low-cost measuring devices. **CONS:** Fails on some processes; lacks profile-tuning tools. **COMPANY:** Delta E (510/237-5577, www.Delta-e.com). **LIST PRICE:** \$399.

Natural Scene Designer 2.0

CLUNKY INTERFACE MARS 3-D-TERRAIN GENERATOR

NATURAL SCENE DESIGNER 2.0 is a 3-D-rendering and -animation program with a specialized mission: creating photo-realistic nature scenes. As such, it draws inevitable comparisons to MetaCreations' Bryce 3D. But although Natural Scene Designer has a few features you won't find elsewhere, its clunky interface makes it a tough sell.

Producing a landscape is a straightforward affair. Create or import a terrain; define its surface features as a combination of snow, rock, vegetation, or soil; choose from a variety of light, sky, and water settings; and then add objects, such as trees, bushes, rocks, or imported models. Once you've set up the scene, you can render a still image, a QuickTime animation, or a panorama ready for conversion to a QuickTime VR movie.

One of the program's strongest features is its ability to import 3-D landscapes from the U.S. Geological Survey (USGS). You can also create terrains by using a built-in fractal landscape generator or by importing gray-scale PICT images.

Once you've created a terrain, you can add a variety of objects: spheres, blocks,

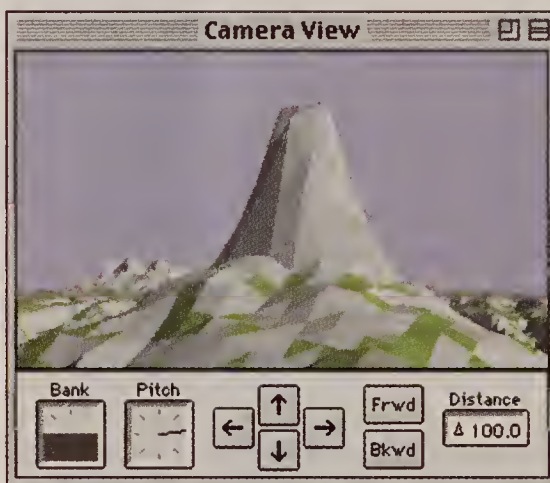

Restricted View Natural Scene Designer 2.0 provides only two views of your scene.

cones, and cylinders. The program provides limited options for choosing object surfaces, but you can also import textured objects in the QuickDraw 3D 3DMF format.

Besides producing primitive objects, the program designs trees, bushes, rocks, and lakes. When rendered, the trees look reasonably realistic except for a lack of detail in individual leaves. The program also includes a fast ray-tracing engine for rendering still images

or animations. Unfortunately, it's hobbled by an interface more appropriate to shareware.

Natural Scene Designer gives you only two views: a camera view and a view of the terrain from above—and only the camera view lets you see an object from different sides. For this reason, you'll want to use the camera view to build most of your scene, which means you'll be continually moving the camera through the landscape rather than leaving it in the spot you want to photograph.

The program also relies on numeric fields for positioning the camera and objects. Sure, you can move and resize objects within the camera view, but if you want any precision, you need to enter numbers in an Object Properties dialog box. To add to the hassle, the program comes with a hardware lock.

Macworld's Buying Advice Natural Scene Designer 2.0 has some attractive features, but with its poorly designed interface and limited options, it falls far short of its similarly priced competition, Bryce 3D.—STEPHEN BEALE

RATING: ★★ **PROS:** Fast ray tracing; imports USGS terrain models. **CONS:** Clunky interface; limited generation; hardware lock. **COMPANY:** Natural Graphics (916/624-1436, www.naturalgfx.com). **COMPANY'S ESTIMATED PRICE:** \$299.

PageSentry 2.5

PRICEY MONITORING UTILITY GUARDS WELL

WEBMASTERS OFTEN RELY ON customer complaints to tell them that the company home page is off the air. Maxum's PageSentry 2.5 watches your servers for you—from your office or from across the Internet—automatically notifying you by e-mail or alpha page when problems arise.

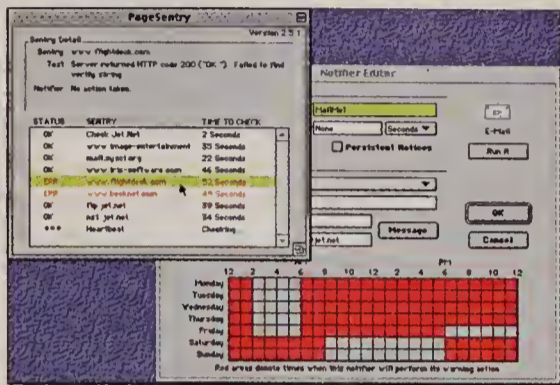

Watchful Eye PageSentry monitors multiple TCP/IP servers simultaneously and generates multiple notifications when servers go off- and online.

PageSentry is a small application that can run in the background of any Internet-connected Macintosh. It comes with a well-

written user guide, online documentation, and some sample AppleScripts for use with pagers or remote power-control devices. You configure a list of probes—called sentries—that periodically test specific protocols on specified servers, and a list of people to notify by either e-mail, pager, or Apple event. PageSentry then quietly checks your servers for proper operation, emitting notifications when servers become unreachable or respond incorrectly, and then when they return to normal operation. A handy status display lets you see problems at a glance.

The program includes numerous perks. For example, you can probe servers using HTTP, FTP, SMTP, Telnet, AppleShare IP, DNS, and arbitrary TCP/IP streams and configure multiple notification techniques—e-mail, alpha paging, or AppleScript. Included are AppleScripts for Mark/Space Softworks' PageNow, Ex Machina's Notify, and Sophisticated Circuits' PowerKey Pro. The PowerKey AppleScript lets you automatically reboot a nearby server when PageNow finds it unresponsive. You can schedule and customize notifications to occur only during certain time periods, to automatically repeat, and to wait a predetermined interval before sounding the alarm. These features combine to make PageSentry easy to configure

for even complex monitoring chores.

PageSentry has no obvious technical faults, and the affordable entry-level package lets you configure up to ten sentries and ten notifiers. Alas, the next-larger PageSentry package costs nearly three times as much, entering the range of full-fledged network monitors. However, although PageSentry performs some of the functions of a full-blown network monitor, its feature set is not as complete.

Macworld's Buying Advice If you're monitoring just a few services on two or three servers, you won't go wrong with PageSentry's attractive price and good performance. However, if you need to monitor numerous services on several servers, you may want to consider spending a little more for a full-fledged network-monitoring tool, which can also report on performance over time in addition to performing other high-end functions.—MEL BECKMAN

RATING: ★★★½ **PROS:** Multiple protocol support; scheduled notifications; periodic status summary; AppleScript support. **CONS:** Expensive for more than ten sentries. **COMPANY:** Maxum Development (630/830-1113, www.maxum.com). **LIST PRICE:** \$149 for 10 sentries and notifiers; \$395 for 100 sentries and notifiers.

Introducing a New Service to Readers...

Macworld | **Get**
info

www.macworld.com/getinfo

Macworld's **NEW**
Online Reader Service

FileMaker Pro Users (addicts) SHOULD NOT READ THE FINE PRINT!

Unless... You're a FileMaker Pro user who's seriously interested in learning more about maximizing your knowledge of FileMaker Pro. The following URLs store some of the world's most empowering information about FileMaker Pro. Thousands of successful techniques and secrets behind mastering FileMaker Pro can be found. Use your web browser to connect to either ISO FileMaker Magazine at <http://www.filemaker.com/mw199/>, Everything CD for FileMaker Pro at <http://www.everythingcd.com/filemaker/mw199/> or the industry's hottest selling instructional product titled Scriptology "FileMaker Pro Demystified" at <http://www.scriptology.com/mw199/>. You'll never know how much you can do with FileMaker Pro unless you check out any one or all of the resources mentioned here. We even have a 100% money back guarantee on both our free and paid resources (just in case you have a problem with free information).

FileMaker® Pro is a registered trademark of FileMaker, Inc.

ReBirth RB-338 2.0

CLASSIC RHYTHM SYNTHS IN SOFTWARE

WHAT'S OLD IS NEW AGAIN. Just ask the folks at Volkswagen or fans of analog synthesizers. Those old instruments that musicians gladly abandoned are now considered classics and are highly prized. And just like the new Beetle, these instruments are beginning to reappear, in this case as software. One such creation is ReBirth RB-338 2.0, from Propellerhead Software (marketed by Steinberg), an application that mimics three of Roland's venerable rhythm synths: the TR-808 and TR-909 drum machines and the TB-303 bass module.

Granted, those model numbers probably mean bupkis to you. The sounds are familiar, though—just think of the drum machine in Phil Collins's "In the Air Tonight" or the bass and drum tracks in any of today's "house" dance mixes. ReBirth is a remarkably convincing imitation of Roland's rhythm boxes. Not only are the sounds virtually indistinguishable from those of the original but the software versions also look, and for the most part operate, just like the Roland machines.

As with its analog counterparts, you

develop ReBirth songs—by creating and stringing together a series of short drum and bass patterns—the old-fashioned way. On the TR-808 and TR-909, you select a tempo, start recording, and assign different drum sounds to buttons that represent 16 sixteenth notes. For example, to create a *boom-chick-boom-chick* bass and snare pattern, you assign the bass drum to buttons 1 and 9 and the snare to buttons 5 and 13. The two TB-303's can also be programmed in this manner or by step-recording—assigning a pitch to a sixteenth note, clicking on the Step button, and then assigning the next pitch to the next sixteenth note. This process



Flashback ReBirth provides digital versions of old rhythm synthesizers that would otherwise cost a small fortune.

so closely mimics the old ways that it may seem tedious to those accustomed to creating riffs with modern MIDI sequencers.

While remaining faithful to the sound and design of the original machines, ReBirth adds several modern-day goodies. For instance, in Song mode, you can twiddle any of ReBirth's many tone controls in real time and record that twiddling—change a sound's tuning and resonance over time, for example. And using an included program called ModPacker, you can plug your own sounds into ReBirth as well as create a custom interface. You can also export your ReBirth tunes as AIFF or WAV files.

Macworld's Buying Advice ReBirth is an outstanding achievement, both aurally and visually. Modern musicians who missed out on the analog years and are interested in the sounds of yore should give ReBirth a long look and listen. And if you're like me and tossed the analog gear ages ago, maybe you're ready for the sound to be reborn.

—CHRISTOPHER BREEN

RATING: **PROS:** Sounds and operates like the real thing; customizable. **CONS:** Not much easier to program than the real thing. **COMPANY:** Steinberg (818/993-4161, www.steinberg.net). **LIST PRICE:** \$199.

Knees Banging Your Chin?

The Problem

Bending your head over the handlebars and crying out "Vroom, Vroom" doesn't move you any faster. You don't have the time to answer your mail, be it electronic, voice, or snail, let alone find qualified staff. And, you have no idea how long you'll need them, or what they'll need to know tomorrow to keep up with your changing needs.

The Solution

Contact us. At HireKnowledge, we're not interested in bells and whistles but in helping you optimally fulfill your staffing needs. What results isn't colorful new streamers dangling from the ends of the handlebars or a shiny new horn (Honk! Honk!), but a comprehensive solution to your staffing needs. Whether it's that unique individual who has a technical background and a flair for proposal writing, or the graphic artist who can switch platforms with ease, we've got the help you need. Knowing that, why don't you climb off of that tricycle and give us a ring?



HireKnowledgeSM
Putting Intelligence to Work

1.800.937.3622

www.hireknowledge.com

Baltimore • Boston • Chicago • Dallas • Kansas City • Philadelphia • Providence • San Francisco • St. Louis • New York • Washington DC

Choose 207 at www.macworld.com/getinfo

Our quality and craftsmanship haven't won a single award.

**Take Home The Professional's Choice:
The ViewSonic PT771.**

They've won 400.

ViewSonic® proudly presents the latest member of our award-winning family, the PT771 Professional Series SonicTron® monitor. This 17" (16.0" viewable) monitor is tailor-made for professionals who require the excellent quality, high resolutions and superb performance that ViewSonic delivers.

| Model | ViewSonic PT771 | Sony 200ES | Sony 200GS | Sony 200PS |
|---------------------------|--------------------------|--------------------------|--------------------------|--------------------------|
| CRT Size/Viewable | 17"/16.0" | 17"/16.0" | 17"/16.0" | 17"/16.0" |
| Aperture Grille Pitch | 0.25AG | 0.25AG | 0.25AG | 0.25AG |
| Maximum Resolution | 1,600 x 1,280 | 1,280 x 1,024 | 1,600 x 1,200 | 1,600 x 1,280 |
| Horizontal scanning Freq. | 30-92 kHz | 30-70 kHz | 30-85 kHz | 30-92 kHz |
| Vertical Scanning Freq. | 50-160 Hz | 50-120 Hz | 50-120 Hz | 48-160 Hz |
| Warranty | 3 year CRT parts & labor | 1 year CRT parts & labor | 3 year CRT parts & labor | 3 year CRT parts & labor |
| Low Radiation | TCO '95 | MPRII | MPRII | TCO '92 |

Quality and Craftsmanship.

ViewSonic is acclaimed for its quality, and the PT771 is a fine example. It has an ultra-fine, 0.25mm aperture grille pitch, sophisticated SonicTron technology that delivers clear, crisp images, and a SuperContrast™ screen for brilliant, bold colors. The PT771 also offers a super fast 86Hz refresh rate at a 1,280 x 1,024 resolution, OnView® controls for fast, push-button screen adjustments and Plug & Play which supports easy installation under Windows® 95 and 98. Ask for the better monitor at the better price. ViewSonic, the leader in quality and craftsmanship.

And that's not just one opinion. It's 400.

For the dealer nearest you, call

ViewSonic at (800) 888-8583
and ask for agent 81345, or
visit our website at:
www.viewsonic.com/mac.



Beyond Brilliant.



GS771
March 1998



G810
January 1997



PT813
January 1998

Choose 59 at www.macworld.com/getinfo



ViewSonic®
See The Difference!™

Mars Rising

1980s-STYLE SHOOT-'EM-UP SCORES BIG

PERHAPS AMBROSIA SOFTWARE should consider a name change—something along the lines of Children of Galaga or Old Skool Software. No other company has gotten so much mileage out of renovating mid-1980s arcade hits. Mars Rising is the latest installment in the series, and while it riffs on a familiar theme, the entertaining shoot-'em-up proves that sometimes it ain't the song; it's the way you sing it.

Mars Rising needs a back story about as much as a Steven Seagal movie needs a plot. But for all you arcade rats moonlighting as method actors, here's an explanation for the game's mayhem: Martian rebels (or patriots) have attacked and destroyed nearly all Terran military forces on Mars and in Martian airspace. You must counterattack, using the advanced Terran Vac-Fighter to destroy the Martian Defense Forces on the ground and in the air.

With your conscience soothed (or with dreams of conquest stoked), you are dropped into the cockpit of a fighter-bomber winging over a two-dimensional landscape that scrolls at a constant rate from

the top to the bottom of the screen. Your mission: as you fly, gun down incoming aerial enemies and drop bombs on ground targets. Completely destroying a squadron of airborne baddies nets you either a star (which converts to points at the end of the



Pay Attention If the Martian Defense Forces catch you napping, they'll eat you alive.

level) or a power-up. Power-ups enhance your ship's capabilities in many ways, including increasing your shield capacity and increasing the number of bombs or bullets you fire per salvo. It's possible to fly for a while without this assistance, but power-ups are essential to surviving later levels.

Brightly colored and vaguely cartoon-

ish, Mars Rising's graphics could have been lifted from a stand-up arcade machine. The busy, constantly changing landscape and tendency for enemy forces to explode messily make it difficult to identify live threats and incoming fire, but that's the price you pay for the game's fast and furious pace. Ambrosia backs the carnage with thumping techno soundtracks and plenty of sound effects to help you sort out the action.

Play Mars Rising solo or with a friend, in which case you compete for points and power-ups. Two-player action must take place on a single machine, as Mars Rising has no provision for network play. You can control your vehicle with the keyboard or mouse, but if you plan to spend much time with Mars Rising, find a good joystick or game pad.

Macworld's Buying Advice Mars Rising is good, old-fashioned, finger-cramping, put-your-brain-on-hold fun. Playing Mars Rising is like being back in the arcade—except you've still got your quarters when you're done.—CAMERON CROTTY

RATING:  **PROS:** Fast action; great graphics; finger-twitching fun. **CONS:** Occasionally difficult to see what you're shooting. **COMPANY:** Ambrosia Software (716/325-1910, www.ambrosiasw.com). **LIST PRICE:** \$20.



Best
Reseller
Prices.

HE'S GOT
A WEBSITE.
DO YOU?

E-Commerce
Enabled

Resellers, We Refer
Design Work

30 Day Money Back
Guarantee

The Best Support and Pricing in the Industry.

Yeeehaaaaw! It's what you'll say when you sign up with or switch to Interland® web hosting. Prices from as little as \$19.95 a month. Dual DS-3 connections for extra speed. A whopping eighty megabytes of disc space. Guaranteed 99.9% uptime. 24x7 toll-free support for the wee hours. And pricing with absolutely no hidden charges. You'll be happy, we guarantee it!

Check out our website and discover why more and more people worldwide are trusting their websites to Interland. Whether you're a computer veteran or just getting started, you'll receive the best service, support and technology the industry has to offer. At a price that's right for you. Not to mention a great reseller program. Give us a call today, and let Interland bring you the world.

Pricing From \$19.95 per Month

Call Today 1-800-599-0547
(404) 586-9999

Speed. Reliability. Support.
interland
Web Hosting
www.interland.net

Enter to win
two tickets
to the '99
Super Bowl.

DYNAMO USERS ARE NEVER PENALIZED
FOR UNNECESSARY ROUGHNESS.



D Y N A M O 640 SE

Buy the new DynaMO 640
internal or external drive before
12/31/98 and get a free carrying case
and a chance to win 2 tickets to the
'99 Super Bowl.
Call, or visit our website for details.

If there's one removable storage solution that can take what you dish out, it's DynaMO[®] 640SE from Fujitsu. Its media cartridges are resistant to moisture, magnets, x-rays and shock. Which means your work is well protected from all types of on-the-job fumbles (except maybe repeated collisions with 300-pound linemen). Your wallet is well protected, too. A 640MB cartridge costs \$19.95,* and it can be rewritten more than 10 million times. DynaMO 640SE is also covered by our No Excuses[®] limited warranty, so in the unlikely event of a defect, you'll get a replacement drive in two business days. So start saving your work on DynaMO 640SE. It's a very smart game plan. For more details, call, or visit our website.

FUJITSU

(800) 831-8094 ext. 302 www.fcpa.com/winwithMO

©1998 Fujitsu Computer Products of America, Inc. All rights reserved. Certain restrictions apply to the No Excuses limited warranty. Valid in the U.S. and for U.S. residents only. Call (800) 626-4686 for full details. Fujitsu Computer Products of America reserves the right to modify at any time without prior notice any of its procedures for obtaining warranty or post-warranty service, including the addition and deletion of specific products covered under this program. DynaMO, No Excuses and the No Excuses logo are trademarks or registered trademarks of Fujitsu Computer Products of America, Inc. Fujitsu and the Fujitsu logo are registered trademarks of Fujitsu Ltd. All other trademarks mentioned herein are the property of their respective owners. *MSRP. No purchase necessary to enter sweepstakes. For Official Rules and details, go to our website at www.fcpa.com or call (800) 831-8094 for a fax copy of Official Rules. Sweepstakes only open to legal U.S. residents 18 years and older. Offer void where prohibited.



Got Mac?

Get Connectix!



Connectix Corporation 2955 Campus Drive San Mateo, CA 94403
tel. 1800-395-1785
website: www.connectix.com/freedemo

©Copyright 1998 Connectix Corporation. Connectix, the Connectix logo, RAM Doubler, Speed Doubler, Surf Express Deluxe and Connectix Virtual PC are registered trademarks of Connectix Corporation.



Virtual PC

Now your Mac can do Windows!
Run the latest PC software on your Mac with
Connectix Virtual PC™, including games, popular
business and home applications.
Available with DOS®, Windows® 95 and Windows 98.

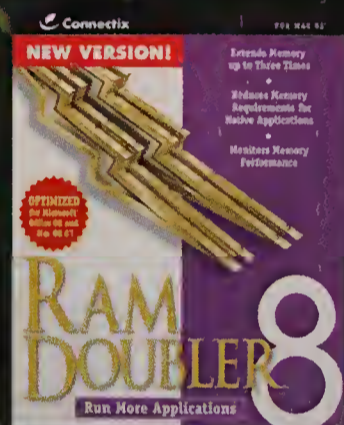

RAM Doubler 8

Run More Applications Simultaneously!
Run the newest Mac OS and Microsoft Office™ 98 suite
on your iMac with RAM Doubler 8™, without the hassle
of adding more memory.



Surf Express Deluxe

Surf and Search the Internet Faster!
Surf Express™ is the award winning web-accelerator,
recommended by cnet, ZD Net, PC Computing and
Mac Addict. Works with both Mac and PC.

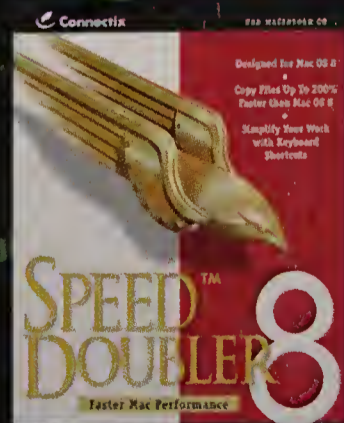

Speed Doubler 8

Speed up your Mac!
"steroids for the Mac" (Mac Addict). Your Mac will perform
at its best with this perfect compliment for OS 8.5.
Run software up to 100% faster. Back-up your files quickly,
easily and automatically. And much more.

Compatible with Mac OS 8.5

The PowerBook

No Matter How Far You Roam, Our Advice

Freedom is not a word most of us associate with the heavy-but-lovable Macs that sit on our desks surrounded by a tangle of papers and cords. But our PowerBooks are different. Sleek and mobile, PowerBooks are made to move. With one tucked under your arm, you can pick up your work and go. Anywhere, anytime.

Or can you?

Between batteries dying and heavy bags of equipment wearing deep grooves in your shoulders, traveling with a PowerBook isn't always a smooth ride. That's why we've assembled this PowerBook Field Guide, filled with expert tips; gear to fit your traveling needs; the best new ultraportable projectors; and above all, ways to keep sane and work smarter wherever the road takes you.

Survival Skills.....page 73

Road Gear.....page 79

Traveling Light.....page 83

Field Guide

Will Keep You Working at Peak Efficiency



Photographs by Mark Johann

IS YOUR 28.8 MODEM
COMING BETWEEN YOU
AND YOUR ENJOYMENT
OF THE INTERNET?

The World's Best-Selling
56K Modem.



If your modem's not in a hurry, it's just in the way. That's why it's time to move to V.90 U.S. Robotics® 56K* desktop modems from 3Com. They deliver significantly greater overall performance† than other V.90 56K modems for high speed downloads and real-time online games.

3Com U.S. Robotics®

So get over to your nearest 3Com retailer or find us at www.3com.com/56k for additional information. Because, when it comes to getting the most out of the Internet, the modem makes the difference.

35

*Capable of receiving at up to 56 Kbps and sending at up to 31.2 Kbps. Due to FCC regulations on power output, receiving speeds are limited to 53 Kbps. Actual speeds may vary. Requires compatible phone line and server equipment. Complies with both the determined V.90 ITU 56K standard and x2 technology protocols. Standard officially determined in February, 1998; ratification expected in September, 1998. See www.3com.com/56k †Henderson Communications Laboratories performance tests of leading internal data fax modems, June 1998. ©1998 3Com Corporation. All rights reserved. 3Com, the 3Com logo and U.S. Robotics are registered trademarks and *More connected.* is a trademark of 3Com Corporation.

3Com® More connected.™

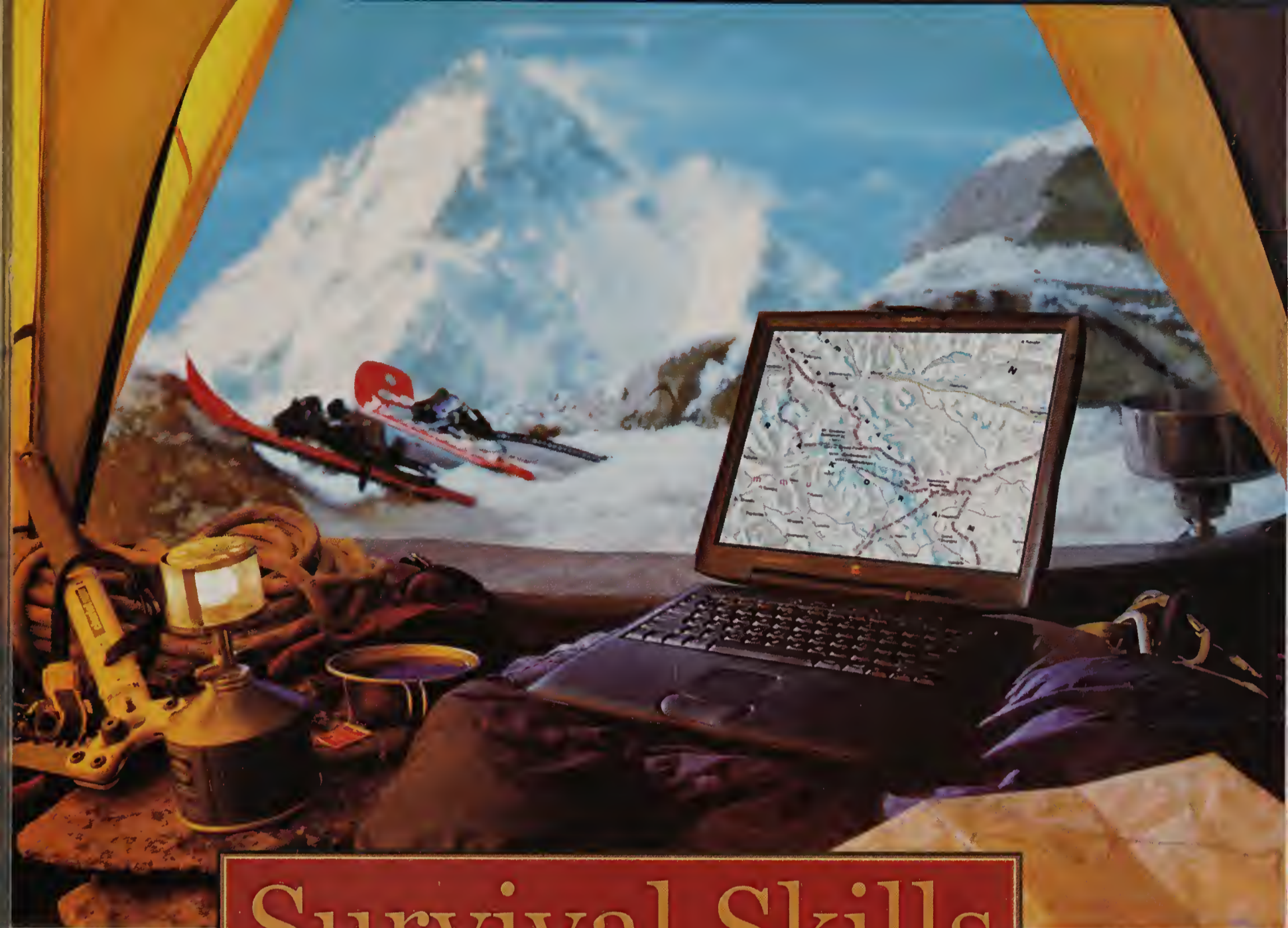

Survival Skills

Expert PowerBook Tips for When You're on the Go

BY DAVID POGUE

With their G3 horsepower and gigantic screens, today's Mac laptops bring us closer than ever to the Holy Grail of portable computing: forgetting that we're not using a desktop computer.

Unfortunately, one road trip will burst that bubble in a hurry, as you're quickly mired in low-battery warnings and connection hassles you'd never get with a deskbound Mac.

But don't despair. If you can find room in your bag for *Macworld's* collection of expert tips and tricks for the mobile Mac user, you'll be able to work in far-off places just as easily as if you were back at the office.



PACK IT UP, PAL

Before heading off to the airport, your first task is to get your important files onto the laptop. You can do so the wired way, the quick way, or the space-age way.

Perform Instant Network Hookups

It's easy to hook up a PowerBook to another individual Mac: use a standard serial (StyleWriter) cable to create a tiny, Mac-to-Mac LocalTalk network, or an Ethernet crossover cable (about \$10) to create a much faster Mac-to-Mac Ethernet connection without needing a hub or router.

Try Superfast SCSI Transfers If your files are big or your time is short, on the other hand, put your PowerBook into

SCSI Disk Mode, in which your PowerBook impersonates an external hard drive for another Mac.

To set this up, you need a special cable, such as the \$30 SCSI Doc from APS Technologies (816/483-2749, www.apstech.com) or the \$28 dark-gray HDI-30 SCSI Disk Adapter cable from Apple (800/795-1000, www.apple.com). (Don't confuse it with Apple's light-gray HDI-30 SCSI *System* cable.)

Now open the PowerBook Setup control panel or (on 1998 and later models) the PowerBook SCSI Disk Mode control panel. Specify a SCSI ID for your laptop, 1 through 6, just as though it's going to be a scanner or another SCSI device. Finally,

shut down both Macs, connect the far end of the Disk Adapter cable to your desktop Mac and the near end to your PowerBook, and turn on the PowerBook.

When you turn on the desktop Mac, the PowerBook's hard-drive icon shows up just as though it were an external hard drive. You can drag huge files back and forth, reveling in the speed of the copying.

Investigate Infrared Beaming If you're not up for the hassle of dealing with cables and SCSI addresses, try the PowerBook's infrared-beaming feature. The infrared (IR) port, the dark translucent-plastic plate on every PowerBook and iMac, sends and receives files from one Mac to another through the air, without a single cable connection. (You can even retrofit an existing Mac with infrared features by using a \$70 Farallon AirDock; 510/814-5000, www.farallon.com.) Setting up your wireless Mac-to-Mac network is remarkably easy.

1. Open the Infrared control panel (if you don't have this control panel, skip to step 2). Choose either IRTalk, a Mac-only language that's a lot like LocalTalk, or IrDA, a faster, more universal networking scheme. (Both Macs must be set to use the same protocol.)

2. Open the AppleTalk control panel and choose Infrared Port from the pop-up menu.

3. Launch Apple IR File Exchange, a program in the Apple Extras folder on every PowerBook and iMac hard drive. Position the two Macs so that their transmitters face each other. Amazingly, any Macs in range show up as "drop-box" folder icons. Now just drag file or folder icons from your desktop



Securing a Safe Line Road Warrior's Modem Saver Plus can keep your modem from getting fried by foreign phone lines.

onto the icons of the receiving Macs. When the progress bar indicates that the job is done, the recipient should open the Apple IR File Exchange folder. Inside is a

FOUR WAYS TO STAY CONNECTED

THE POWERBOOK IS A VITAL TOOL BECAUSE IT KEEPS you in touch with your office and the rest of the world, no matter where you might be. Here are a few tips to help you make the most out of your remote connections—whether you're using your PowerBook in a hotel room or at home.

1. **UPGRADE TO MAC OS 8.5.** With the latest update to the Mac OS, Apple has finally created great remote-access software. In this release, the PPP and Remote Access control panels have merged to become version 3.1 of the Remote Access control panel. This version lets you dial remote-access servers and Internet service providers with equal ease from the same interface. Better still, you can now connect to the Net—and even choose what number to dial—all from the Control Strip, with no control panels or helper applications necessary.

2. **GET TIMBUKTU PRO.** Netopia's (510/814-5000, www.netopia.com) remarkable Timbuktu Pro 4.0 software (\$190 for a two-user pack) is a must-have tool if you frequently dial in to your office network from a remote location.

With Timbuktu Pro and either a TCP/IP or an AppleTalk connection, you can view the screen of any other Mac that's running Timbuktu. As a result, you can run applications that you didn't install on your PowerBook, search through e-mail you left at the office, and more. But Timbuktu's not just for screen sharing: its file-transfer feature beats the Finder hands down when used over modem lines, making it the ideal tool if you want to grab those files you forgot to bring with you.

If you don't want to leave your computer on all the time (a necessity if you'll be using Timbuktu) but want it to be there

when you need it, consider also getting one of Sophisticated Circuits' (425/485-7979, www.sophisticated.com) PowerKey power strips. The \$100 PowerKey Pro 200 features two sets of remotely controlled outlets; the \$200 PowerKey Pro 600 offers six individually controlled outlets. PowerKeys can be controlled both by computer and via telephone, so you can turn your computers (and other devices) on and off from far, far away.

3. **BYPASS FINDER COPIES.** If your file server at work runs AppleShare IP, you may be able to access it via an FTP client such as Dartmouth College's free Fetch (www.dartmouth.edu/pages/softdev/fetch.html), Stairways Software's \$35 shareware Anarchie Pro (www.stairways.com), or Peter Li and Vincent Tan's \$20 shareware NetFinder (www.ozemail.com.au/~pli/netfinder) rather than having to mount it on your desktop. You'll be able to transfer files in a much speedier fashion—FTP uses less network overhead than is used in mounting Mac volumes and performing Finder copies.

4. **SAVE YOUR E-MAIL ON THE SERVER.** If you use a POP e-mail client such as Eudora Pro or Light from Qualcomm (619/658-1291, www.eudora.com) or Outlook Express from Microsoft (425/882-8080, www.microsoft.com), be sure to set your preferences to leave mail on the server. If you don't, your PowerBook will delete every message after downloading it, leaving you no way to retrieve those messages and file them when you return to your work. If you set this preference, you can ensure that your e-mail in-box at work contains a complete copy of your correspondence. If you don't, you'll get a conspicuous hole in your e-mail trail every time you head out on the road.—JASON SNELL

folder named IR Receiver—which contains whatever data you just beamed through space.

Unlike traditional Mac file sharing, IR doesn't require setting up passwords, registered users, or levels of access. You might call it *don't-plug-and-play*.



A BATTERY OF POWER SAVERS

Once you're out the door, you may quickly discover that your PowerBook's "three-hour" rating is an exercise in sheer optimism. For better battery mileage, try these tricks.

Work Dimmer, Not Harder If you can work with your screen at half brightness, you'll add 20 minutes to each battery charge; your backlight is one of the laptop's biggest power consumers. Also turn off AppleTalk while on that plane or train; it, too, saps away power unnecessarily.

Exercise Spin Control A spinning hard disk is one of the PowerBook's biggest power guzzlers; a nonspinning one, on the other hand, uses almost no power at all. If you run your laptop off a RAM disk, as described in the sidebar "Double Your Battery Life," your battery can last four hours or more.

If the RAM-disk approach is a bit much, at least use selective spin control by pressing ⌘-control-shift-0 (zero) to chill your hard drive when it's overactive. Do so promptly after saving your work, for example, to prevent the hard disk from spinning pointlessly for 15 more minutes (or whatever period you've specified in the Energy Saver or PowerBook control panel).

Choose Disk-Shy Apps For additional spin control, favor programs that don't access the hard disk very often. Microsoft programs, alas, are among the most disk-intensive. Instead, draft your speech in the \$70 Mariner Write from Mariner Software (502/222-6695, www

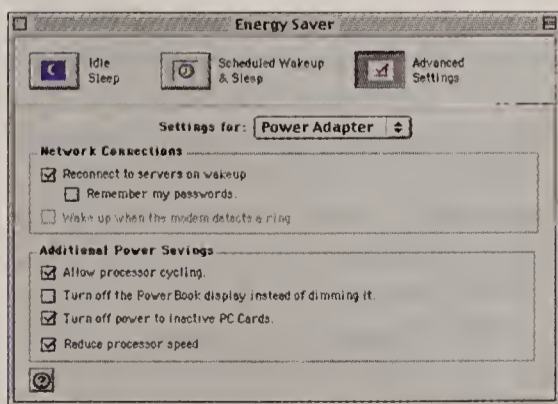

G3 Slowdown When battery power is more important than horsepower, use Energy Saver's Advanced Settings panel to slow down the works.

OFF-ROADING WITHOUT A MAC

JUST BECAUSE YOU'RE A HARD-CORE MAC USER DOESN'T NECESSARILY mean you always lug a PowerBook around with you when you're out of the office. Sometimes it's simply impractical to tote one along. But if you've got a 3Com (801/431-1536, www.palm.com) Palm III (or other Palm-family handheld organizer), you don't have to lose touch.

Quick and Dirty If you've got electronic documents you want to read on the go without the inconvenience of paper, consider Florent Pillet's \$20 shareware Palm Buddy utility (<http://perso.wanadoo.fr/fpillet/>; see the screen shot "Palm Pal"). Not only is this a great tool for backing up and installing files on a Palm device (without the hassle and overhead of 3Com's own HotSync software), but Palm Buddy can also automatically translate any text file into a document that is readable by any Palm-based Doc reader, such as the \$17 shareware TealDoc, from TealPoint Software (www.tealpoint.com), or the \$30 AportisDoc, from Aportis Technologies (503/736-3240, www.aportis.com).

Mini Mail To keep up with e-mail on a Palm device, you won't need anything faster than the 14.4 Kbps of 3Com's teeny \$120 PalmPilot modem. If you're on a budget, you can use Ian Goldberg and Steve Gribble's free Top Gun Postman (www.isaac.cs.berkeley.edu/pilot/), which downloads mail from a POP/SMTP server directly into the Palm OS's built-in Mail program. For more full-featured e-mail, consider the \$40 MultiMail Professional 2.0, from Actual Software (978/475-2690, www.actualsoft.com), or the \$50 HandMail 2.0, from Smart Code Software (619/597-7544, www.smartcodesoft.com).

Dainty Data At press time, 3Com had not yet released the much-promised version 2.0 of its Mac HotSync software (see "Mac's Best Friend," August 1998). But when that software does appear, Rob Tsuk's Jfile to FileMaker Conduit (www.tsuk.com/fmc/) will let you sync FileMaker databases with the \$20 Jfile from Land-J Technologies (www.land-j.com/jfile.html), a popular Palm flat-file database. That means you'll also be able to look up and edit flat-file databases in the palm of your hand.—JASON SNELL

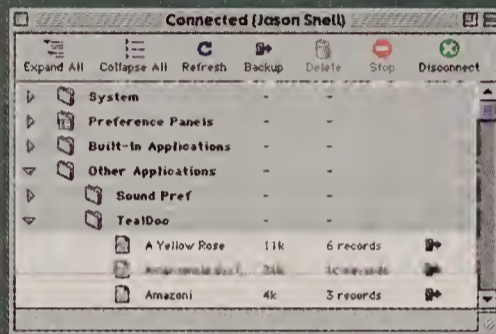

Palm Pal A friendly drag-and-drop interface makes Palm Buddy a must-have utility.

.marinersoft.com) or Apple's \$99 AppleWorks while on the plane.

Tweak Your Processor Your PowerBook offers several secret controls that can minimize its processor's energy use. On the newest PowerBook G3 models, these options are in the Energy Saver's Advanced Settings panel; on older laptops, open the PowerBook control panel and, while holding down the option key, move the Easy/Custom switch into the Custom position.

If you turn on the Allow Processor Cycling option, you'll permit your processor to rest between bursts of activity, saving juice (but making games and movies jerkier). The option Turn Off Power To Inactive PC Cards (in the G3

series only) may eke out a few extra minutes by cutting off the juice to any inserted PC Cards such as modems or Ethernet cards, although not every card will be able to turn off when you choose.

Finally, the Reduce Processor Speed option slows down even a G3 to a feeble 25MHz (see the screen shot "G3 Slowdown"). To be sure, this is a dire last resort—but when the battery warnings are coming up and all you're doing is finishing your speech, this option may be just the ticket.



UP IN THE AIR

A little strategic thinking goes a long way toward making your plane trip—and your airport time—PowerBook-friendly.

LOCATION IS EVERYTHING

FEW THINGS ARE MORE FRUSTRATING than settling down with your PowerBook and realizing that before you can check your e-mail, you've got to change the settings in a half dozen control panels.

That's why Apple created Location Manager, a powerful tool that lets you change dozens of preferences with just one click. It's quite tricky to set up, but once you have properly configured Location Manager, you can finally stop tinkering with settings and get to work.

HOW IT WORKS

Location Manager is a lot like the Extensions Manager control panel: you can create different sets, or collections of preferences, and turn them on and off in one fell swoop instead of one at a time. Using Location Manager 2.0 (a part of Mac OS 8.5), you can remotely control AppleTalk, TCP/IP, printing, Extensions Manager, File Sharing, Internet preferences, Modem settings, Remote Access settings (including dial-up phone numbers), your time-zone settings, and even the volume of your PowerBook's speaker. (Previous versions of Location Manager offer a more limited amount of control.)

Just because you *can* control all of these settings doesn't mean you'll want to. Based on your particular situation, you may need to control only a handful of these items. If you use a PowerBook both at home and at work, you might want to create a different set of AppleTalk and TCP/IP settings for each locale, as well as a different default

printer and a separate set of Internet preferences. If you travel frequently, you may just want to create settings for your most common destinations—complete with each city's time zone and the local number for your Internet service provider.

No matter what you use your PowerBook for, chances are good that Location Manager can save you time. That's why it's worth it to take the time to get to know more about it.

Step 1. Getting Started

To begin, open Location Manager (see the screen shot "Home Base") either directly from the Control Panels list in the Apple menu or via its Control Strip panel (an icon that looks like two sets of preference files joined by a pair of red arrows). Use the File menu to create your first new location. If you've already configured your PowerBook for a certain place, it's important that the first location set you create includes all these preferences—otherwise you might lose them when you create another set.

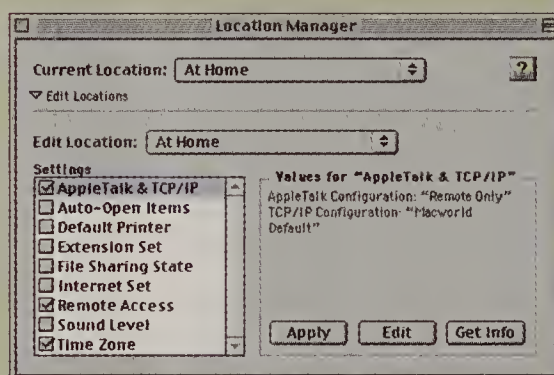

Home Base Choose which settings to change from Location Manager's main window.

Step 2. Describe Your Preferences

Location Manager refuses to work with any preference named Default, so you must open all the control panels you plan to modify with Location Manager and give your preference settings descriptive names. The method involved is the same for the AppleTalk, TCP/IP, Remote Access (which integrates the pre-OS 8.5 Remote Access and PPP control panels), and Modem control panels: choose Configurations from the File menu (see the screen shot "Get Set"), click on Rename, and give your settings names like Work Ethernet TCP Settings or Remote Access 800 Number. The Extensions Manager and Internet control panels have a more intuitive interface for creating and managing multiple sets of preferences via pop-up menus.

If you want to be extra-safe, hit the Export button and export your settings to files. That way, if anything bad happens to your settings, you'll still have a copy you can import later using the Import button.

Step 3. Create a Location

Now you're ready to create your first location. Location Manager learns settings by picking up whatever ones are currently active and storing them away. If you've got things just the way you want them, you should be able to click on items one at a time in the Settings area of the Location Manager window and click on Apply to add that setting to your location. If you need to make changes, click on the Edit button, and Location Manager brings up a dialog box that lets you open the control panel you need to edit (see the screen shot "The Springboard").

Sit Smartly Savvy PowerBookworms ask for an exit-row seat; only then do they have enough tray-table room to open a PowerBook G3 all the way.

Seek Outlets Your wait at the gate doesn't have to be fruitless thumb-twiddling time; power outlets lurk at every gate of every airport (and bus and train station, too). Use them. To find one, you need to think like a janitor; these outlets are generally concealed on the side of a pillar, virtually never convenient to a seat. If your need for juice is stronger than your pride, you're going to have to sit on the floor.

Don't expect to find outlets when

you're in the air. On some of the newer airplanes, there are power outlets right on the seats in first class—but you can use them only if you own the correct adapter (they're not standard outlets). You can usually find an outlet in the plane's lavatory, but we doubt that your fellow passengers would look favorably upon you if you commandeered it to use your PowerBook.

Sleep in the Air A plane trip is a series of on-and-offs for the typical PowerBook: on for security, off for take-off, on for the ride, off for dinner, and so on. Do what the pros do: *never* shut down your PowerBook. Instead, simply

close the lid when you're not using the machine (or press ⌘-shift-0 [zero]), thus putting it to sleep. (Be sure it's actually asleep, as indicated by the tiny blinking light on the case.) The next time you want to use your computer, all you have to do is press any key. For a speedier PowerBook wake-up, select Make AppleTalk Inactive from the AppleTalk On/Off Control Strip module.

The fact is, there's no good reason to shut down your PowerBook *ever*, unless you want to change its SCSI or monitor configuration, shelve it for days, or ship it. When you're not working, your PowerBook should be sleeping.

When you're making changes to settings, remember to be *extremely* careful. Location Manager works by remembering the *name* of the configuration setting you use in a particular control panel, not the actual setting itself. If you open the Remote Access control panel, replace your user name, password, and phone number, and close the window, saving your changes, you've overwritten your previous settings and there's no way to get them back.

Before you make any changes, be sure to create a *new* set of preferences. In the TCP/IP, AppleTalk, Modem, and Remote Access control panels, you do that by choosing Configurations from the File menu, clicking on Duplicate, giving this new setting a descriptive name, and clicking on Make Active. Now you can make all the changes you need to.

When you've finished changing settings in a control panel, you close it, and Location Manager reappears. Now when you click on the Apply button, your newly changed settings are added to the location you're editing.

Once you're done, you can create as many locations as you need to fulfill your travel requirements. For each new location, choose New Location (or Duplicate Location if the location you want to make is similar to an existing one) from the File menu (see the screen shot "Makin' Location"). Then go through all the relevant control panels, make changes to your settings, and apply those changes to your new location.

POWERFUL POSSIBILITIES

The least documented of Location Manager's settings—the Auto-Open Item setting—may

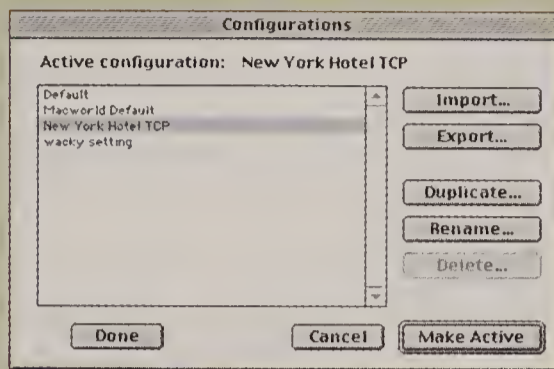

Get Set Export, rename, and change settings from the Configurations window.

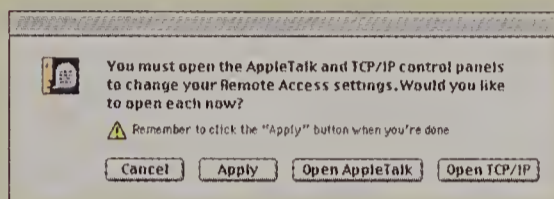

The Springboard From here, you can open control panels, configure them, and apply the result to your location.

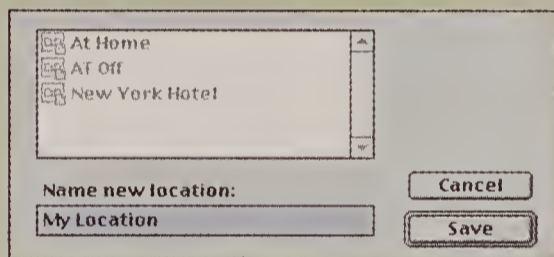

Makin' Location Be sure to make new locations so you don't destroy your old ones.

be its coolest. It can instruct Location Manager to open files, applications, or other items whenever you select a new location. One of the best uses for this is to designate server aliases as Auto-Open Items so that server volumes

remount automatically. By making an AppleScript an Auto-Open Item, you can also have your Mac perform customized tasks.

And whether you're using a Mac at home or on the road, if you share space on that Mac with other users, you'll find Location Manager a blessing. Since Location Manager can change your TCP/IP, Remote Access, and Internet settings at the same time, you can use it to quickly shift between different Internet accounts, right down to different home pages and default Web browsers.

Caveat User Location Manager is quite powerful, but it could be both easier to use and more comprehensive. Although version 2.0 is an improvement over its predecessors, Location Manager is still one of Apple's uglier interface efforts. Switching locations is accompanied by a pop-up window filled with scary streams of text and the occasional hard-to-comprehend error message.

Ideally, Location Manager should let users make changes to preferences without having to click through individual control panels (and without risking accidental destruction of their settings). It should also be able to control more preferences, including power-management settings and perhaps even Mac OS 8.5's themes.

There's plenty of room for improvement, but as it is, Location Manager is quite useful today. If you've grown tired of wrestling with your PowerBook's settings every time you travel, you should invest the time to configure it now. Your effort will pay off down the road.—JASON SNELL



SURVIVING THE HOTEL ROOM

In some ways, arriving at a hotel is a welcome moment, since you can stop worrying about running out of battery juice. But in other ways, the hotel room presents its own challenges.

Print for Free The first challenge—the lack of a printer—is easily surmountable. Using your PowerBook's fax modem, *fax* your printworthy documents to the front desk, addressed to yourself. Presto: fresh, crisp printouts. Moreover, most hotels these days use plain paper (not that curly fax stuff), deliver the fax to your door, and don't charge a penny. The front desk never

needs to know that the fax originated in the same building.

Jack In Safely Another traveler's hazard is the digital (PBX) phone jack, found in virtually every hotel room. Such jacks look exactly like normal (analog) phone jacks—but if you plug your PowerBook's modem into a digital line, you could fry the modem for good.

Fortunately, the bedside phones in most modern hotels have a special analog jack on the side, marked "Data" or "Dataport," into which you can safely plug your modem. (Don't forget to bring a generous amount of telephone cord with you.) If you worry that your hotel

won't offer such a jack, travel with a digital-line converter, such as the \$150 TeleSwitch Plus, from TeleAdapt (www.teleadapt.com). Or try another helpful tool—the \$30 Modem Saver Plus, from Road Warrior (<http://warrior.com>, 714/434-8600), which tests a jack for safety *before* you plug in.

Simplify Your Setup Once you've arrived at your temporary location, don't bother with the usual ritual of changing your PowerBook's clock to the new time zone, typing in the local Internet-access number, adapting to a different network setup, and so on. Instead, do all that with a single click, using the

Location Manager (see the sidebar “Location Is Everything”).



HOME AGAIN

After your travels, you've got one challenge left: returning your on-the-road documents to your desktop Mac without confusing them with previous versions.

Get in Sync Synchronizing files is the whole purpose of the unsung but extremely handy File Synchronization control panel (called PowerBook Assistant before Mac OS 8.5). It helps you synchronize parallel folders on your PowerBook and your desktop Mac and makes the process drag-and-drop easy.

On either computer, drag a PowerBook folder onto one side of the control panel and a desktop-Mac folder onto the other. Then, whenever you click on Synchronize, the File Synchronization control panel makes sure that the two folders

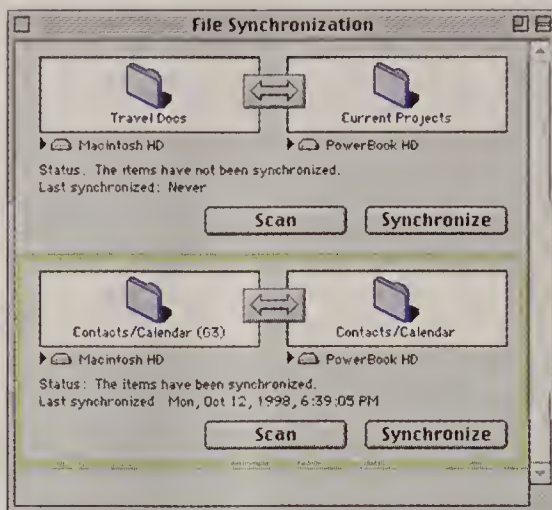

That Syncing Feeling Don't let your travel documents get confused with the versions on your home Mac—use the File Synchronization control panel to synchronize them with the click of a button.

contain exactly the same set of files—the newest only. (In the screen shot “That Syncing Feeling,” you can see two different pairs of folders being synced.)

Zip through Data Transfers If you would rather avoid the hassle of networking your desktop Mac with your PowerBook after each trip, outfit your PowerBook with a \$250 PowerBook Zip drive, from VST Technologies (978/635-8200, www.vsttech.com). This way, you can keep all your documents on a single Zip disk, which you transfer between machines before and after each excursion.

THE LAST WORD

Let's face it: simply carrying one of today's gorgeous, sleek, high-horsepower PowerBooks is enough to impress friends, coworkers, and passersby. But mastering the tricks of expert PowerBook use will let you venture farther. And isn't that the reason you bought a laptop in the first place? **m**

Contributing Editor DAVID POGUE (www.davidpogue.com) is coauthor of *Macworld Mac Secrets*, fifth edition (IDG Books Worldwide, 1998).

DOUBLE YOUR BATTERY LIFE

FRUSTRATED BY THE SHORT LIFE OF LAPTOP BATTERIES? Then replace your juice-guzzling hard drive with a disk that doesn't move and uses no battery power at all. That's the purpose of a RAM disk, a portion of memory the Mac treats like an additional (but extremely fast) floppy disk. When you work off a RAM disk with your hard drive spun down, a fresh PowerBook battery can last four hours or longer per charge. The bad news is that setting up a RAM disk as your in-flight hard disk requires some dedication and effort, but the good news is that it's a onetime setup.

1. First, figure out how much disk space your RAM-disk contents will require—total the disk-space requirements of, for example, your word processor, your documents, and a stripped-down System Folder. (At minimum, a basic Mac OS 8.1 setup should include the following: System, Finder, PowerBook Enabler, Text Encoding Converter, Geneva 9-point, and the Appearance extension.)

2. Open the Memory control panel; turn off virtual memory and click on the RAM Disk On button. Move the slider to the right until it shows the size you calculated (or larger, if you can afford the RAM). Turn on Save On Shut Down or Preserve RAM Disk Contents so that you won't have to repeat this business later. Restart.

3. Now a RAM-disk icon appears at the right side of the screen. Copy your files—the mini System Folder, your word

processor, and your documents—onto it. Also copy onto it an alias of the Startup Disk control panel.

4. Finally, use Startup Disk to select the RAM disk as the start-up disk. Restart again. (If the laptop doesn't boot, press 1-option-P-R during start-up to nuke the RAM disk and start over.) You'll be shocked at how fast your Mac now starts up—in about three seconds. At this moment, however, your hard disk is still spinning; you aren't getting any extra battery mileage until you complete the next step.

5. Drag your hard-disk icon to the Trash! The Mac warns you that you're doing something nutty; click on OK. (If the disk is still spinning or spins up unbidden from time to time, press 1-control-shift-0 [zero] to stop it cold.)

At last you've arrived at an amazing point. Your PowerBook is absolutely silent, runs about three times as fast as before, and uses very little battery juice. Everything on the RAM disk is safe, even if your laptop crashes, sleeps, or restarts. Only removing both battery and power cord—or shutting down without having used the Save On Shut Down option in the Memory control panel—obliterates your RAM disk.

To summon the hard disk back to the screen (to back up your document, for example), double-click on the Startup Disk alias on your RAM disk. And to terminate your RAM disk, use the Startup Disk control panel to choose your hard disk, restart, erase the RAM disk, turn off the RAM-disk option in the Memory control panel, and restart again.



Road Gear

Enhance Your PowerBook with These Essential Extras

BY STEPHAN SOMOGYI

The latest PowerBook G3 comes with almost everything a mobile Mac might need, but there are still situations when you require something more. If you have an older PowerBook that's still performing yeoman's service—and isn't in evident need of replacement—there's also a lot you can do to make your mobile work flow more smoothly.

KNOW YOUR SLOTS AND BAYS

Sure, you know your PowerBook has interesting places for you to put expansion hardware, but you may not know all that these bays and slots can and cannot do.

The PowerBook bays were built to be flexible, but it's not always clear what

hardware bits go where (see the diagram, "The Lay of the Land"). Take, for instance, the PC Card slots. Every PowerPC-based PowerBook has them, but depending on how old your PowerBook is, these slots can have different capabilities.

All PC Card slots can accept basic PCMCIA Type II cards, such as most modems. One of these cards can fit into each of the available slots. You can also fit a dual-height Type III card—such as a hard disk for a high-end digital camera—into any PowerBook with PC Card slots, although one of these bigger cards will take up both spaces.

The PowerBook G3 series, however, has particularly snazzy PC Card slots.

These support the faster CardBus cards, which can move data at up to 132 MBps, compared with a standard PC Card's meager 20 MBps. The trick is that although CardBus cards look almost identical to ordinary PC Cards, they're shaped just differently enough so that they won't fit into a standard PC Card slot. PC Cards, on the other hand, work just fine in CardBus slots. As a result, though, you may not be able to use newer expansion hardware in all your PowerBooks.

Another flavor of PC Card that might discombobulate the unsuspecting PowerBook user is the Zoomed Video (ZV) card. ZV cards also look like standard PC Cards, but they're designed

for processing and generating video data.

ZV cards need a ZV-capable slot—the *bottom* slot in G3 PowerBooks (as well as in the 3400- and 2400-series PowerBooks). If you put it in the wrong place, the ZV card won't work.

WATCHING MOVIES

If you're up in the air a lot, there's one obvious reason to add an extra piece of hardware to your PowerBook—so you can watch movies while you're on the plane. Unless you're lucky enough to own a DVD-equipped PowerBook G3/300, you'll need to get the PowerBook DVD-Video Kit from Apple (\$499; 408/996-1010, www.apple.com).

The DVD-Video Kit has three parts: a DVD-ROM drive, a ZV card that decodes the audio and video data on DVD movie discs for playback, and Apple's own DVD Software. The DVD-Video Kit's drive has an additional bonus: it can read DVD, CD-ROM, and CD-RW discs (a standard PowerBook CD-ROM drive can't read CD-RW).

Unfortunately, when we fired up Apple's DVD Software 1.0, we met a few rude surprises. If you don't take battery-saving precautions, such as setting the Separate Timing For Hard Disk Spin Down option in the Energy Saver control panel to five minutes or less, even a full battery won't last two hours. "No biggie," you say. "Just put the PowerBook to sleep and pop in a fresh battery." Right? Sadly, it's not so.

Apple's DVD software can't remember how far into the film you are, which means in most cases you'll have to hunt manually through the movie for your place (some DVD titles support scene selection, which makes this a *bit* easier). This problem isn't related to the battery running out, either: the DVD Player loses track of the last-viewed spot on the disc anytime the PowerBook sleeps. A version 1.1 software update geared to fix this problem should be available from Apple's Web site by the time you read this.

PRESENTING WITH YOUR POWERBOOK

Another reason to add to your PowerBook is if you frequently make presentations on the road and have the misfortune to own a first-gen-

eration PowerBook G3. A bug in the first revision of this model's motherboard (since fixed) makes it impossible to set the external video ports' resolution to 640 by 480—the standard many projectors expect. Help is \$349 away in the shape of iXMicro's (408/369-8282, www.ixmicro.com) ix3D Road Rocket (see *Reviews*, November 1998).

The ix3D Road Rocket is a CardBus-based video card, originally created to add support for a second monitor to the PowerBook. At the heart of the Road Rocket is the same accelerated 2-D/3-D chip set found in iXMicro's ix3D PCI cards. Its video performance isn't as high as that of the PowerBook's built-in ATI Rage Pro LT chip set. However, for the purposes of straightforward presentations, the difference isn't likely to be noticeable.

If you need the Road Rocket, you'll appreciate the fact that it works, but be forewarned—it's *huge*. It not only takes up both slots, but it sticks out a good two inches. This means you have to be careful not to corner too tightly when running through hallways, and you can't use a

100-Mbps Ethernet card or the DVD Kit's ZV card when the Road Rocket is installed.

JACKING INTO A FAST NETWORK

The PowerBook G3 series' stock 10BaseT Ethernet port meets most users' demands, but if you plan on connecting to a fast new 100BaseT network while traveling, you need a card to do so.

These new 100BaseT networks—which run at 100 Mbps instead of "regular" Ethernet's 10 Mbps—are increasingly ubiquitous, and if you're moving graphics files around, the added bandwidth is a big help. Both Farallon and TDK have 10/100BaseT CardBus cards for PowerBooks that speak both 10BaseT and 100BaseT.

The \$179 TDK Network Flyer 100 (530/478-8421, www.tdksystems.com) card has a dongle—a connector between the card and the phone cable—that locks securely into the card. Unfortunately, this dongle doesn't have any indicators to show whether the network connection is live. Such telltales are priceless when you're trying to hook yourself into

THE LAY OF THE LAND

Before you buy expansion hardware for your PowerBook, it's good to know your way around its slots and bays. Here's a map of all the PowerBook G3's ins and outs.



another net for the first time. Often, if you have trouble, the little lights help you figure out where the problem is.

In contrast, the \$179 Fast EtherTX-10/100 CardBus Adapter from Farallon (510/814-5000, www.farallon.com) has two LEDs on the network end of its dongle. One shows network activity and the other indicates whether the network is running at 10 Mbps or 100 Mbps—very handy.

CONNECTING FAR FROM HOME

The 56-Kbps modem built into the current PowerBook G3 is fast and flexible enough for most folks, but if you travel abroad or venture far from land lines you may want to consider more untethered options. Also consider a new modem if you own an older PowerBook.

International Modem Issues

What problems might you run into if you travel far from home? First off, while PowerBooks bought in the United States are *likely* to work internationally, they contain modems approved for use only in the United States and Canada.

Modems must pass FCC requirements before they're approved for use in the United States, and by the same token almost all foreign countries have requirements. In some places it's actually illegal to connect a nonapproved modem to the public phone network. To get around all this, you need a modem that has been approved for use—and meets the electrical specifications—in the country to which you are traveling.

One possibility is 3Com's (800/638-3266, www.3com.com) \$269 Megahertz 56K Global Modem PC Card. More than 20 countries have formally approved this V.90 modem for use. While it isn't specifically designed for the Mac, it works well in a PowerBook, thanks to the Mac OS's built-in drivers. However, you won't be able to access the modem's more advanced features unless you run the software in Virtual PC or another emulation program.

Cell-Phone Connections Just as modems lack one international standard, cell phones don't have standardized modem connectors. To send information out over a cell phone, you'll need a modem that explicitly supports these devices, such as 3Com's \$249 Megahertz 56K Cellular Modem PC Card with

XJack connector. This card has built-in support for cellular phones—on the edge of the card is a second plug for a dongle to connect to the cell phone.

One Wireless Option If you're in the San Francisco Bay Area; Washington, D.C.; or Seattle, you have another mobile connectivity solution: the wireless Ricochet from Metricom (800/469-4735, www.ricochet.net). The Ricochet comes in three different flavors, distinguished mainly by size, battery life, and price (ranging from \$149 to \$599, depending on the level of service you order). All of



Mobile Movies All software glitches aside, Apple's DVD-Video Kit can turn your PowerBook into a traveling entertainment center.

them connect to a PowerBook's printer-modem port and look like small external modems with foldout antennae.

When you're inside a Ricochet service area, the modem behaves like a standard modem—no strings attached. You can connect to your home network over the Internet using the Ricochet Internet service, or connect directly to other Ricochet-equipped computers. This means if your desktop machine back at the office is equipped with a Ricochet as well, you can set up point-to-point network connections to transfer files back and forth or run Timbuktu sessions.

Older PowerBook Boosts The most apparent reason to get a new modem is if you own an older PowerBook. The newest PowerBook G3 has a built-in modem that supports the V.90 modem standard, created to put an end to the 56-Kbps modem standard wars (see "The Modem Showdown," April 1998). However, you can't upgrade some earlier PowerBook modems to V.90, which means you won't be able to connect to V.90 ISPs or dial-in servers.

The 3Com Megahertz 56K Global Modem PC Card and the Megahertz 56K Cellular Modem PC Card both support the V.90 standard.

Fortunately for PowerBook users, the necessary drivers for PC Card modems are built into the Mac OS. That means unlike LAN cards—which require Mac-specific drivers—most PC Card modems, even those *not* formally aimed at the Mac, work when plugged into a PowerBook. One notable exception to this rule of thumb is the \$239 RealPort Modem 56-GlobalAccess, from Xircom (805/376-9311, www.xircom.com), which in our testing caused the PowerBook to hang.

THE LAST WORD

Thanks to its expandability, you can customize a PowerBook to suit most mobile computing needs. There are plenty of products designed for other situations you may find yourself in.

If you're lugging around loads of data, you can get a \$350 Zip drive from VST (978/635-8200, www.vsttech.com) that fits into the PowerBook G3's media bay. For videoheads, there's the \$249

Kritter, from Par Technologies (602/922-0044, www.partec.com)—a small digital camera that you can connect to your PowerBook via a ZV card—as well as Par Technologies' \$129 CapSure card for capturing full-motion analog video. Soon you'll also be able to buy PC Cards with a USB interface so that you can connect to iMac peripherals.

Even today, PowerBooks aren't first-class citizens in the world of mobile peripherals. This is clear from the dearth of drivers for PC Card and CardBus network cards, and the lack of formal support from many PC Card modem vendors. Still, with the roaring success of the PowerBook G3, it shouldn't be long until more products are officially declared PowerBook-compatible. Then you'll have even more options to take with you wherever you may roam. ■

STEPHAN SOMOGYI has fond memories of his PowerBook 100, managed to get the PowerBook 500-series PCMCIA cage to work, and dreams of a G4-powered, 2400-size PowerBook.

DIVERSITY.
IT'S A BEAUTIFUL THING.



At MetLife, we know that respect for individual skills and talents can create something beautiful: a workplace where everybody can contribute to his or her full potential.

MetLife®



Traveling Light

High-Quality Ultraportable Projectors That Won't Break Your Back

BY JEFF PITTELKAU

How many times have you swept into a room, all fired up to give a socko sales pitch or wow an awaiting class, and discovered that the projector you've rented won't work with your PowerBook? Or perhaps you already own a projector, but it's so big and heavy that you dread hauling it out for another road trip.

Whether you've had it with renting or with lugging around yesterday's technology, relief is at hand—and in a very easy-to-carry form. Weighing in at under ten pounds each, these new lightweight multimedia projectors—dubbed “ultraportables”—offer incredibly bright and colorful images as well as unprecedented reliability.

We evaluated the features of six new

ultraportable projectors head-to-head and enlisted a panel of experts to test how the image quality of the units compared. Although two projectors stood out from the crowd, our testing—both subjective and objective—showed that all these projectors reflect a major advance in projection technology. Every model we tested offered better image quality and cost about \$1,000 less than projectors we reviewed as recently as March 1998 (“Prime-Time Projectors”). Better yet, the new models weigh, on average, about four pounds less.

TOTABLE TECHNOLOGIES

The streamlined size of these new projectors owes itself to advances in two distinct

under-the-hood technologies. Two of the projectors we looked at feature polysilicon liquid-crystal displays, or LCDs: the \$7,499 PowerLite 5500C, from Epson America (www.epson.com), and the \$5,999 UltraLight LS1, from Proxima (www.proxima.com).

The other four projectors are based on a technology called Digital Light Processing, or DLP. These include the \$5,999 Boxlight 4050, from Boxlight (www.boxlight.com); the \$5,995 EzPro 700, from CTX (www.ctxintl.com); the \$5,999 LP425, from In Focus (www.infocus.com); and the \$4,955 MultiSync LT80, from NEC Technologies (www.nec.com). In the last year, both technologies have

Traveling Light

undergone refinements that have reduced size, weight, and cost while at the same time improving image quality.

Triple-LCD Technology Projectors based on larger, heavier, single-LCD modules are all but gone. Today's LCD-based projectors instead use a tiny—and light—assembly of three active-matrix, polysilicon LCDs, each about the size of a postage stamp.

How do they work? Each LCD creates a gray-scale image that corresponds to either the red, green, or blue *content* in the image being projected. Next, an assembly of color filters and prisms adds the necessary *color* to each channel and then recombines the three separate images into one to create a full-color image.

The triple-LCD approach not only creates a lighter-weight projection engine but also lets more light through than the old, single-LCD approach—all of which makes for a clearer, brighter image on screen.

DLP Technology The other new invention making projectors more shoulder-friendly is DLP. Texas Instruments coined this brand name to describe the technology used in projectors based on its Digital Micromirror Device, or DMD.

The DMD is a small rectangular device that uses an array of tiny mirrors to create an image. Each micromirror corresponds to a bit on a special type of memory chip that coordinates the mirror's movements. As the mirrors move, they reflect pulses of red, green, blue, and white light toward the projection lens. Your eye then integrates this information into full-motion, full-color images.

(For more information, see the diagram, "Travel-Worthy Technologies.")

THEATER-IN-A-BOX

These new projectors may be skimpy in size—did we mention that not one of them stands taller than two G3 PowerBooks stacked together?—but they don't skimp at all on features.

Sync or Swim When a projector's resolution is out of sync with your Mac's, the projected image may lose detail, appear improperly cropped, or exhibit a

images smoothly. Unfortunately, the Boxlight 4050 and In Focus LP425 synchronized the resolution by discarding or doubling pixels whenever the Mac's displayed resolution wasn't exactly 800 by 600 pixels—a less desirable approach, since fine details can be lost.

Simple Setup All the projectors feature on-screen menus that guide you through the manual aspects of projector setup, such as switching inputs from Mac to VCR, making color adjustments, and adjusting speaker volume.

We found Epson's menu system the easiest to navigate and make adjustments with. The In Focus and Boxlight menu systems, which are identical, were slow to respond, while the Proxima menus were difficult to navigate.

In their favor, however, the In Focus and Boxlight projectors had the most-robust autoseup calibration procedures of any of the projectors we tested, which means that they offered the closest to a plug-in-and-go experience.

Remotely Controllable All the projectors we tested, except the Boxlight 4050 and the In Focus LP425, come with remote-control devices that let you move your Mac's mouse from a distance. (Remote-control devices are optional for the Boxlight and In Focus projectors and cost between \$99 and \$199, and \$200 and \$399, respectively.)



Small Surprise The lightest projector in our roundup, the In Focus LP425, weighs 6.8 pounds.

strobe effect. Older projectors typically made you use the sync controls to fix problems like these. Conveniently, these new models all sport automatic circuitry that makes the adjustments for you.

All the projectors we tested did a decent job of matching our test Mac's resolutions of 640 by 480, 832 by 624, and 1,024 by 768 pixels. Most resized our test

LIGHTWEIGHT LIGHT: SIX ULTRAPORTABLE PROJECTORS

| Company | Product | Mouse Rating | List Price | Phone | Dimensions (l x w x h, in inches) | Weight (in pounds) | Technology | Resolution (in pixels) | Warranty |
|------------------|-----------------|--------------|------------|--------------|-----------------------------------|--------------------|------------|------------------------|---|
| Boxlight | 4050 | 👍👍👍 1/2 | \$5,999 | 360/779-7901 | 11.8 x 9.0 x 4.0 | 6.9 | DLP | 800 x 600 | two years; parts and labor |
| CTX | EzPro 700 | 👍👍👍 | \$5,995 | 408/541-6060 | 12.2 x 9.3 x 3.9 | 9.7 | DLP | 800 x 600 | two years; limited parts and labor |
| Epson America | PowerLite 5500C | 👍👍👍 | \$7,499 | 310/782-0770 | 13.6 x 9.3 x 3.7 | 9.4 | triple LCD | 800 x 600 | one year; parts and labor |
| In Focus | LP425 | 👍👍👍 | \$5,999 | 503/685-8888 | 12.0 x 9.0 x 3.6 | 6.8 | DLP | 800 x 600 | one year; parts and labor, excluding lamp |
| NEC Technologies | MultiSync LT80 | 👍👍👍 | \$4,955 | 630/467-5000 | 12.8 x 9.8 x 4.8 | 9.9 | DLP | 800 x 600 | two years; parts and labor |
| Proxima | UltraLight LS1 | 👍👍👍 | \$5,999 | 619/457-5500 | 12.4 x 8.5 x 4.3 | 8.4 | triple LCD | 800 x 600 | one year; parts and labor |

* Company's estimated price.

TRAVEL-WORTHY TECHNOLOGIES

Triple-LCD Projector

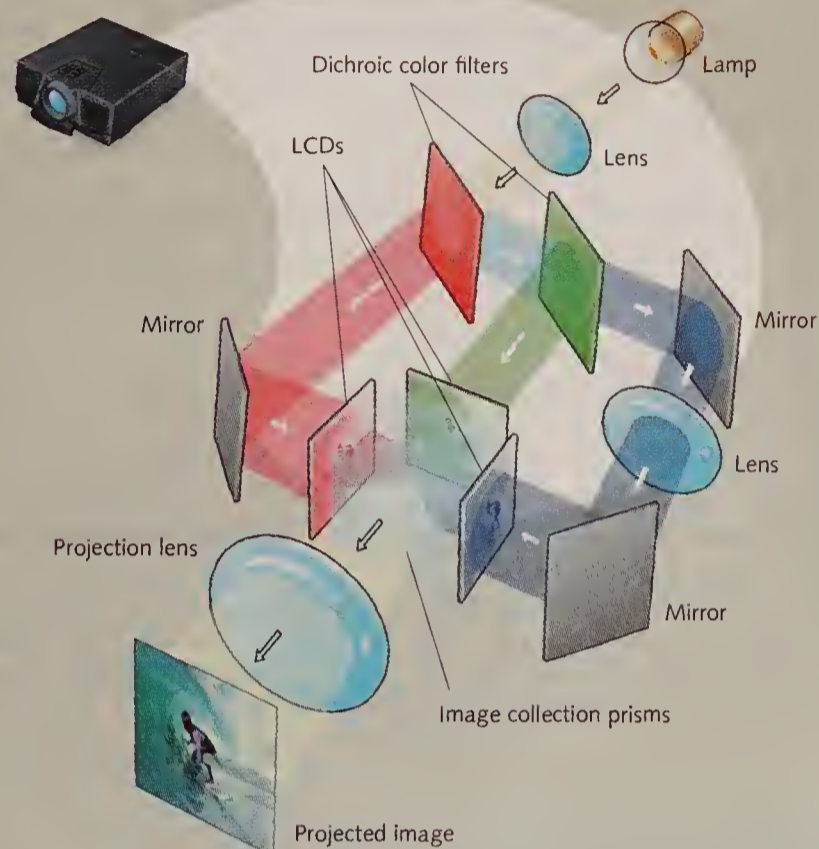

TWO TECHNOLOGIES MADE THIS YEAR'S NEW CLASS of petite projectors possible—Digital Light Processing (DLP) and triple-LCD. Projectors based on either of these engines offer welcome relief to the weighed-down traveler, but each also offers particular advantages and disadvantages.

Their most fundamental difference is how these technologies use light to create projected images. Triple-LCD projectors, as you can see in this illustration, split a steady stream of white light into red, green, and blue light using two dichroic color filters; pass the light through three tiny LCD modules; and finally use prisms to recombine the light into a single color image. DLP projectors use rapid pulses of white light that are filtered through a high-speed, rotating color wheel and reflected off an array of microscopic mirrors mounted on a Digital Micromirror Device, or DMD. These images are recombined by your eye, not the projector.

The most noticeable result of these different approaches is that triple-LCD projectors have better image quality. As DLP projectors create images they flip individual mirrors on and off. Some light can be reflected in the process, which means that darker shades in still and video images often appear to shimmer noticeably.

Be this as it may, since DLP technology *reflects* light rather than *filters* it, as the LCD panels do, very little light is lost and DLP projectors create brighter images. Also, DLP Projectors typically weigh less than triple-LCD projectors because they use fewer and lighter components.

The Epson and Proxima remote-control devices use an infrared receiver on the projector, which requires you to connect the projector to your Mac with a company-supplied ADB cable. We didn't like the CTX and NEC approach—these companies provide a separate infrared

receiver that connects directly to your Mac's ADB port, and that means one more item to carry. You can leave your laser pointer at home if you get either the NEC or Proxima projector, as the remote-control devices for those models have laser pointers built in.

Lamps That Last The halogen lamps of old, which typically lasted less than a hundred hours and burnt out in a flash, are yesterday's news. Every projector we tested features a durable, metal-halide arc lamp instead, which typically should last at least 1,000 hours.

While expensive to replace (\$300 to \$400 each), metal-halide arc lamps don't burn out suddenly and leave you in the lurch. They travel well, since they don't have a filament that's susceptible to vibration. Instead, they dim and take longer to start up as they age, giving you plenty of warning before you need another bulb.

PICTURE-PERFECT

Of course, a lightweight projector that's easy to use may still not fill the bill if it can't project bright, accurate images and

provide decent sound. That's why we took a critical, audience-level pass at these projectors' color, video, and sound capabilities by testing the units with a panel of experts. We confirmed our panel's findings with a series of objective tests (see the benchmark, "Screen Tests").

Color and Clarity Our panel found that in general, the DLP projectors' color quality did not match that of the triple-LCD projectors. In particular, the In Focus LP425 and Boxlight 4050 projected distinctly orange-looking reds.

On the other hand, our experts noted that the DLP projectors created brighter and clearer still images. All the DLP units projected pixels that were larger and closer together than those generated by the triple-LCD projectors. This made images look crisper and more "filled in."

Finally, panel members observed that the Epson PowerLite 5500C and Proxima UltraLight LS1—both triple-LCD projectors—had a few dead pixels, which were visible as tiny red, green, or blue dots in dark areas of projected images.

Comments

Small and light, but has no zoom lens.

Bright projector has a no-frills design.

Excellent quality and easy setup outweigh the expense.

Small and light, but has no zoom lens and no frills.

Same mechanism as CTX projector, but offers better color at the expense of brightness.

Great color; power zoom and focus; somewhat tricky setup; remote includes laser pointer.



Screen Tests

You don't need to compromise on image quality when you opt for one of these small, ultraportable projectors—for the most part. All but two of the projectors we evaluated received at least acceptable scores in all our objective and subjective tests. In general, DLP-based projectors created the brightest images in all our tests, but their image quality suffered when it came to projecting saturated colors and video images. In particular, the Boxlight 4050 and the In Focus LP425 projected images with orange-looking reds and video images with an unacceptably noticeable shimmer. The triple-LCD projectors, on the other hand, produced the most-stable and most-vibrantly colored images and video.

Best results in red.

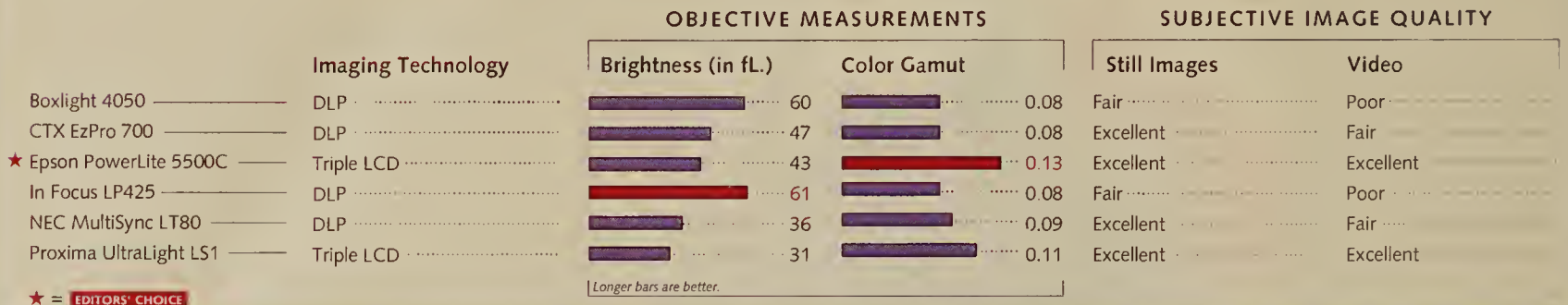

Behind Our Tests

Macworld Lab conducted objective tests with a Minolta CS-100 spot colorimeter. Brightness results are listed in footlamberts and are the average of nine spots on the screen measured at default projector settings. Color-gamut results are stated as a CIE area index and were measured at default projector settings. Subjective image quality was

judged by a panel of three experts. Ratings were given for each projector according to how well it displayed our Adobe Photoshop and Microsoft PowerPoint test images. Subjective video quality was gauged with an S-Video signal from a laser-disc player.—Macworld Lab testing supervised by Jeffy Milstead

Video Quality The triple-LCD projectors were clear winners in video tests. These projectors had the best color and most-stable images. In particular, the Epson PowerLite 5500C performed superbly.

When projecting moving pictures, the DLP projectors produced images that suffered from noticeable shimmering. The reason is that to create shading, these projectors vary the amount of time individual pixels stay on or off.

The shimmering was discernible with the NEC MultiSync LT80 and the CTX EzPro 700 but not nearly as pronounced as that produced by the In Focus LP425 and the Boxlight 4050. This distraction, coupled with unnatural-looking colors, makes these two projectors unacceptable for motion video.

Sound Advice Let's face it: these projectors are tiny, and so are their speakers. While all the projectors our jury evaluated create sound adequate for small-group presentations emphasizing spoken words, not one was acceptable for playing music or presenting to large audiences. If you plan on projecting movies or presentations full of rich sound, buy a set of amplified speakers—or rent a public-address system at your destination.

MACWORLD'S BUYING ADVICE

When you choose one of these projectors, bear in mind that you're also choosing a technology. Pick the one that's best for the material you'll be presenting the most.

If your livelihood depends on killer video presentations, the triple-LCD projectors we tested offer the most-stable video quality and most-vibrant color. If bright, crisp still images are your top priority—for instance, if your presentations primarily use slides—the DLP projectors could fill the bill, although at the expense of less color saturation.

For best overall image quality and ease of use, our Editors' Choice goes to the LCD-based Epson PowerLite 5500C. It offers the most-convenient on-screen menus and controls as well as the most colorful and stable images. Its list price is high, but we expect its *street price* to be more in line with those of the other products we reviewed. The Proxima UltraLight LS1 is a good second choice, but beware: its setup is nowhere as easy as the Epson's.

Still, the DLP projectors are noteworthy for their still-image clarity and high brightness—the highest recorded by our objective tests. Of the DLP models, the nearly identical NEC MultiSync

LT80 and CTX EzPro 700 are the most complete packages. We recommend the MultiSync LT80 above the EzPro 700 because the former's remote includes a built-in laser pointer.

Whichever projector you choose, you'll find yourself traveling light. And that'll leave hands free for all those bouquets tossed on stage after your dazzling, glitch-free presentations. **m**

Macworld Lab Director JEFF PITTELKAU specializes in operating systems and display technology.

EDITORS' CHOICE

★★★★ Epson PowerLite 5500C Easy-to-use menus and controls, plus the best overall image quality on our tests—for still and video images—make this projector worth its price.
Company: Epson America (310/782-0770, www.epson.com). **List price:** \$7,499.

REAL PRODUCTS REAL RATINGS

Reviews you can trust Macworld rates only final shipping products, not prototypes. What we review is what you can actually buy.

Great performance...easy to recognize, hard to duplicate.

21" 110 khz
\$999 ESP

Winning as many awards as we have sets iiyama apart from the competition. And for good reason. All iiyama monitors, including our newest line of 21" CRTs are engineered to meet the highest standards of quality and performance, allowing the user to run the monitor at its highest specified performance and refresh rate.

Consistent quality is maintained because iiyama monitors come from our ISO 9001 certified factories in Japan. We don't outsource or OEM our monitors, so we can always be 100% certain that our high standards are met.

So for high performance at an unbeatable price... get the monitor that can't be duplicated.



| | CRT Monitor Model/ Viewable Area | TCO | Dot Pitch/ CRT Type | Max. Horizontal Scan Rate | Max. Resolution | Est. Street Price |
|-----|-------------------------------------|---------|------------------------|------------------------------|--------------------|----------------------|
| 21" | VisionMaster Pro 502 (19.5" VIS) | TCO '95 | 0.28mm/AG | 110khz | 1800 x 1440@74hz | \$999 |
| | VisionMaster Pro 501 (19.5" VIS) | TCO '95 | 0.28mm/AG | 96khz | 1600 x 1200@75hz | \$939 |
| | VisionMaster 502 (19.5" VIS) | TCO '95 | 0.27mm/dp | 110khz | 1800 x 1440@74hz | \$999 |
| | VisionMaster 501 (19.5" VIS) | TCO '95 | 0.27mm/dp | 96khz | 1600 x 1200@75hz | \$939 |
| 19" | VisionMaster Pro 450 (18.0" VIS) | TCO '95 | 0.25mm/AG | 102khz | 1600 x 1200@80hz | \$699 |
| | VisionMaster 450 (18.0" VIS) | TCO '95 | 0.26mm/dp | 102khz | 1600 x 1200@80hz | \$659 |
| 17" | VisionMaster Pro 400 (16.0" VIS) | TCO '95 | 0.25mm/AG | 96khz | 1600 x 1200@75hz | \$498 |
| | VisionMaster 400 (16.0" VIS) | TCO '95 | 0.26mm/dp | 96khz | 1600 x 1200@75hz | \$459 |
| | S702GT (16.0" VIS) | TCO '95 | 0.28mm/dp | 96khz | 1280 x 1024@85hz | \$369 |
| 15" | VisionMaster 350 (13.7" VIS) | MPR-II | 0.28mm/dp | 69khz | 1280 x 1024@65hz | \$239 |

| | TFT/LCD Monitor Model | TCO | Pixel Pitch | Max. Horizontal Scan Rate | Max. Resolution | Est. Street Price |
|-------|--|---------|-------------|------------------------------|--------------------|----------------------|
| 14.1" | Pro Lite 36a (with OSD) | TCO '95 | 0.279mm | 62.5khz | 1024 x 768@75hz | \$899 |
| | Pro Lite 36b (80° Viewing Angle) | TCO '95 | 0.279mm | 62.5khz | 1024 x 768@75hz | \$1,129 |
| 15" | Pro Lite 38a (with OSD) | TCO '95 | 0.279mm | 62.5khz | 1024 x 768@75hz | \$1,129 |
| | Pro Lite 38b (with OSD, USB & Speaker) | TCO '95 | 0.279mm | 62.5khz | 1024 x 768@75hz | \$1,179 |



1998
VisionMaster 450



January 6, 1998
VisionMaster Pro 17



iiyama

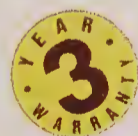

ISO 9001

For the name of your local dealer call: (800) 394-4335 • www.iiyama.com

© 1998 iiyama North America, Inc. All rights reserved. iiyama, the iiyama logo, and the RSVP logo are trademarks of iiyama North America, Inc. All other trademarks are the properties of their respective owners. 8 hours a day/5 days a week/50 weeks a year. MTBF excludes CRT life, which may vary from model to model. Prices and specifications are valid as of 10/01/98. Estimated Street Price is shown, actual price may vary. Prices do not include shipping, handling and any applicable taxes. Specifications are subject to change without notice. As an Energy Star™ Partner, iiyama has determined that this product meets the Energy Star™ Guidelines for energy efficiency. For more information, please write us at 575 Anton Blvd., Suite 590, Costa Mesa, CA 92626. 800/394-4335, 714/437-5111; Fax: 714/437-5982; Home Page: www.iiyama.com



May 1998
VisionMaster 450



Perfect Five-Star Rating
January 1998
VisionMaster 450
VisionMaster Pro 500



Perfect Five-Star Rating
November 1997
VisionMaster Pro 17



Performance & Technical Excellence
March 1997
VisionMaster Pro 21



Six Time Winner
Jan 1997, Feb 1997, March 1997,
April 1997, May 1997, June 1997
VisionMaster Pro 21



October 7, 1997
VisionMaster Pro 17



March 1997
VisionMaster Pro 21



Twelve Time Winner
July 1996, Jan 1997, March 1997, July 1997,
Sept 1997, Jan 1998, March 1998,
May 1998, July 1998, Sept. 1998
VisionMaster Pro 17
April 1998, August 1998
VisionMaster 450

Choose 39 at www.macworld.com/getinfo

Not Every
Useful and
Powerful
Mac Program
Comes in
a Shrink-
Wrapped Box



BY JOHN FU AND PHILIP DYER

SHAREWARE—THOSE SUPERFLUOUS GAMES, NOVELTIES, AND interface enhancers that clutter your hard drive and distract you from your work. If you've ever had a coworker who thought it was a hoot to play round after round of Jared—that little smiley face that sings off-key Guatemalan folk songs—you know that no good can ever come of shareware. There's no telling where this stuff comes from and how much testing it went through before its release. If you have clients who rely on you to provide professional service on a tight deadline, the last thing you need is shareware . . . right? Wrong.

If you're on a tight budget, you can save a lot of money by choosing shareware and freeware over giant commercial software packages. But even if price is no object, shareware can be an excellent complement to the tools you already have.

Serious

Grappling with Graphics

Not every graphics chore requires Adobe Photoshop; even if you're a Photoshop pro, you may find that you can perform many image-editing tasks more efficiently using shareware.

Let's say you need to convert 500 images from some graphics format you've never heard of into GIF and then reduce them all by 25 percent, run a "sharpen edges" filter on them, and combine them all into a slide show. You could load up Photoshop, Equilibrium's DeBabelizer, and Microsoft PowerPoint to get the job done, or you could save yourself some RAM and time by launching Thorsten Lemke's nimble \$35 **GraphicConverter**. This Rosetta stone of graphics utilities can batch-convert to and from almost any image format, offers a wide range of image-editing options, and can organize your images into a slide-show presentation.



Shareware

If you create graphics for use on the Web, some new commercial applications—notably Macromedia's FireWorks and Adobe's ImageReady—can make the job much easier. But for many people, nothing beats Yves Piguet's free **GifBuilder**, the original GIF-animation tool. Simply create the cels in your favorite image-editing program—GraphicConverter, perhaps—and then use GifBuilder to assemble them. Its drag-and-drop interface and simple transition effects are pleasant enough, but the program's price (or lack thereof) is the nicest touch of all.

The Smooth Sounds of Shareware

If your Windows-using friends are in the habit of sending you sound files they've downloaded or recorded on their PCs, you

can hear them on your Mac—just get Norman Franke's free **SoundApp** and listen to your friends' desperate pleas for a real operating system. This mother of all sound utilities can translate files from just about any sound format into something your Mac can play, which makes the utility ideal for prepping sound files for the Web or a multimedia presentation. Although SoundApp doesn't offer as many special effects as its commercial cousins, its abilities are quite impressive—and it's free.

If you use your Mac to make music, you'll want to try **FreeMIDI**, from Mark of the Unicorn. This complete MIDI operating system offers an intuitive interface, recognizes more than 200 MIDI devices, and provides a pop-up list of 100 popular MIDI synthesizers.



Shareware at Work

Sure, shareware can help you generate and edit content such as images and sounds. But several shareware programs have an even more practical bent, helping you work more efficiently and get yourself organized.

Automate Your Life If you send out tons of e-mail every day or have to key countless entries into a database or word processor, you need an application that automates the process. Riccardo Ettore's \$27 **TypeIt4Me**, for example, can save you time by auto-completing frequently used text strings (such as your name and address) whenever you type a simple abbreviation.

If it's task automation you're looking for—word processing or otherwise—check out Binary Software's **KeyQuencer Lite**. For just \$20, this powerful macro engine can perform complex tasks such as opening a document, merging text into it, editing the text via menu commands, and then e-mailing the finished product to a mailing list at the touch of a button.

Get It Together Even if you use all this shareware to cut your software budget in half and double your productivity, it won't do you a bit of good if you miss an important meeting because your schedule is in disarray. Luckily, one of the best personal information managers available anywhere is only a download away. Chronos's \$40 PIM, **Consultant**, offers an intuitive

interface that makes it easy to keep up with even the busiest schedule and the most unruly collection of contact information.

If your needs are simpler, use Panda Systems' free **PandoCalendar** to mark events on a compact desktop calendar. There's also John Covele's free **Right On Time**, a versatile calendar that keeps your to-do list handy and reminds you of upcoming meetings.

Manage Your Money

Once you've started using shareware to streamline your work habits, you may become so efficient that you'll need a way to keep track of all the additional money you're making. One option is **NetBooks**, Symmetry Software's shareware continuation of the popular PeachTree Accounting; it helps you keep your accounts organized, without requiring that you know a lot about accounting.

If you're a FileMaker Pro user, check out **Estimate & Invoice Tracker**. This free set of FileMaker Pro templates from FileMaker Inc. will help you generate bids and track projects from beginning to end. As your fortunes increase, keep an eye on

your investments with Michael Foreman's \$10 **Financial Portfolio**, a HyperCard stack that stores information about your investments and calculates your net worth.

Crash Savers Nothing ruins your day quite like computer troubles, but several shareware programs can help stop prob-

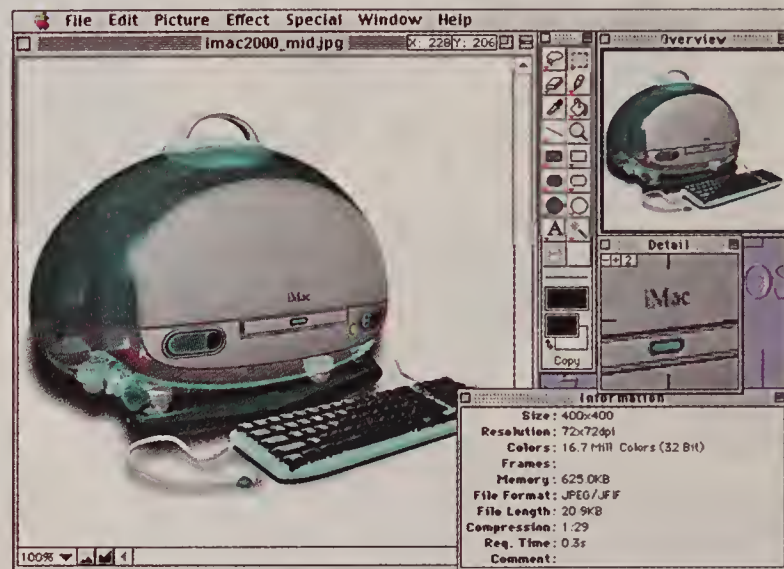

Groovy Graphics GraphicConverter can open images saved in almost any format and even gives you the basic tools you'll need to edit them.

lems *before* they start. You don't necessarily need Norton Utilities to keep troubles to a minimum and fix the ones that do crop up; you can prevent problems by using MicroMat's free **TechTool** to perform the regular maintenance Apple recommends. Although this free version doesn't offer all the analysis and repair tools of its commercial cousin, it can

Whatware? | The fuzzy, twisting line between shareware and commercial software becomes more and more blurred every day. There's no way to fit every product neatly into a single category, but these definitions should help.

COMMERCIAL SOFTWARE

Usually distributed on CDs in shrink-wrapped boxes, commercial software is sold in stores, online, or in a catalog.

Examples: Macromedia Director, Microsoft Office 98

SHAREWARE

Freely distributed by the author on a trial basis, shareware is usually available via an online service or the Web. The author requests that after a certain period of time, often 30 days, you pay a fee for the software if you want to continue using it. Registering shareware often gets you extra features, or at least removes those annoying payment reminders.

Examples: GraphicConverter, Escape Velocity: Override

FREWARE

Freeware is freely distributed software that's available for unlimited use at no cost, though the author retains all rights to the product.

Examples: SoundApp, StuffIt Expander

PUBLIC DOMAIN

Like freeware, public-domain software is freely distributed, except that the author also distributes the source code with permission to modify the product.

Examples: NewsWatcher, Internet Config

WHATEVERWARE

Publishers of whateverware don't want money but do want some kind of recognition or reimbursement. These products range from e-mailware (just send the author an e-mail message if you like the product) to the nonsensical sillywalkware (perform a Monty Python silly walk in public if you like the product).

Examples: OS 8 Views Setter, Iconizer

DEMOS

Scaled-down versions of commercial software products, demos are freely distributed with some features disabled, allowing you to get a feel for the product before purchasing the full version.

Examples: Adobe Illustrator demo, MacSoft's Quake demo

rebuild the desktop from scratch, zap the PRAM, test for damaged System files, and clean up your floppy drive—all while you're fetching your morning coffee.

When SCSI voodoo comes to haunt you and all your external drives seem to have disappeared, use the free **SCSIProbe**, from Newer Technology, to diagnose your SCSI chain and mount volumes with a single command. If what ails you is an extension conflict, use Dan Frakes's \$15 encyclopedic reference, **InformINIT**, to get detailed information about those gremlinesque extensions lurking in the depths of your System Folder.

Even when you've done all you can, sometimes your only option is a clean install of the system software. Alleviate the pain of this procedure by using Marc Moini's **Clean-Install Assistant** (free for personal use) to transfer files from the fallen System Folder to the reborn one.

Bug Zappers Mac viruses have been resurgent as of late, but shareware can help keep your system clean. To eradicate the recent Graphics Accelerator virus, just run John Dalglish's free **AntiGax**. The recent AutoStart virus is no match for Matthias Neeracher's free **WormFood**, which flicks that nasty bug off your hard drive and prevents future infections.

Sadly, John Norstad's free **Disinfectant**, which at one point was able to combat all known Mac viruses, is no longer in production; if you need an all-encompassing antivirus program, you'll have to get a commercial package such as Symantec's Norton AntiVirus or Network Associates' VirusScan or Virex.

Web Wonders

Now that your business is humming along nicely, it's time to put up a Web site to tell the world what you can do. With shareware Internet servers and utilities, you can get your Web site off the ground and ensure that it runs smoothly.

Can You Spell HTML? For most HTML purists, the preferred text editor has long been Bare Bones Software's outstanding BBEdit or its freeware sibling, **BBEdit Lite**. The Lite version offers most of the commercial version's editing tools; both give you a wide array of HTML tools that help you breeze through tedious coding chores.

If you aren't an HTML whiz and need a little more help generating Web pages, turn to Optima System's \$25 **PageSpinner**. While this HTML editor is not



nearly as powerful as the current crop of WYSIWYG products, PageSpinner is more than adequate for anyone who just needs to post a few pages on the Web.

Site-Serving Shareware For serving simple Web sites on your Mac, try Social Engineering's free Web server, **Quid Pro Quo**; it offers most of the abilities of commercial server software and can handle thousands of hits per day. If you want to add FTP services to your site, Stairways Software's \$10 **NetPrez** makes it a snap and even includes Web and Gopher services; if you want to add e-mail service, Stalker Software's free **Stalker Internet Mail Server** is a great choice. Qualcomm also offers an older version of its **Eudora Internet Mail Server** for free.

No matter how meticulously you set them up, servers have a tendency to crash when you least expect it. You could prepare yourself for the inevitable with a \$100 server watchdog or spend just \$20 for Karl Pottie's **AutoBoot**, which restarts your Mac automatically after a freeze. Another Pottie utility, the \$25 **Keep It Up**, attempts to relaunch crashed server applications and can perform regular restarts to help prevent problems.

Crashes aren't the only thing that can bring your Web site to a screeching halt. If an application on your server puts up a dialog box that requires a response, your machine is essentially dead until you click on one of the buttons. Dan Walkowski's free **Okey Dokey Pro** saves the day by checking for dialog boxes as often as you like and automatically clicking on the default button.

More Online Options With Web sites sprouting like tribbles, it's hard to make people aware of your site. Rather than writing the address on a napkin, send potential visitors a shortcut to your site—a file created with the freeware **Internet Launcher**, by Gabriele de Simone. Users simply click on the file to launch their browser and go right to your site. (This works only on Macs; you'll need to keep a napkin handy for PC users.)

If you're not using the Web to publi-

cize your business, chances are you're using it for research. If you're sick of printing 20 pages of images and tables just to get one paragraph of text, download John Moe's brilliant **Net-Print** and print only the text you select.

The Last Word

Big commercial applications will always be around; they simply offer the biggest bang, albeit for the biggest buck. But if you don't want to buy an expensive application just to gain access to a single feature, or if the application you already own doesn't handle certain tasks the way you'd like, don't shy away from shareware. And—this is the best part—if you don't like it, you don't have to pay for it.

Perhaps the best thing about shareware is that so many new products come out every day that this article is probably out of date already. To keep you current, we'll maintain a list of all the shareware mentioned in this article, plus additional shareware items, at www.macworld.com/more/. If you've found other shareware products that help you get your work done better, tell us about them and we'll add them to the list. And if you're looking for a product that doesn't appear on our list, check for it at one of the other sites mentioned in "Bookmarks."

Finally, if you do find a piece of shareware you like, please don't forget to register it. Not only will you be doing the right thing but you'll also be giving shareware authors the incentive to think of more insanely great ways to improve your Mac computing experience. **m**

JOHN FU and PHILIP DYER love shareware because of the powerful features it offers . . . and because they're shameless cheapskates.

Bookmarks

Macworld's Shareware Page
www.macworld.com/more/

Info-Mac HyperArchive
<http://hyperarchive.lcs.mit.edu/HyperArchive/HyperArchive.html>

cnet's Download.com
www.download.com

ZDNet's Macdownload
www.macdownload.com



Authorized Catalog Reseller

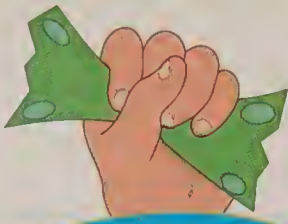

Look for this symbol and **SAVE!**

MacWAREHOUSE

Save over \$1500**

Apple • Iomega • Epson • Hewlett-Packard • MacSoft • Microsoft • Agfa

HP DeskJet 697c Color Printer

Only **\$249!**
BN5686

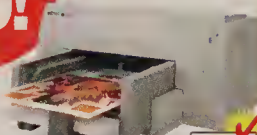

- 5ppm black, 1.7ppm color
- 600dpi black; 600 x 300 dpi color
- Plain paper drop on demand inkjet printing
- Mfr's 1-year warranty



Iomega Zip® USB Drive

Only **\$149^{95!}**
DR9464



- Zip® USB works with both Mac and PC
- Item # DR9464 10-pack 100MB Color Zip Disks, only \$99.95; Ask for item # BN5265.



Epson Stylus Color 740 Printer

Only **\$279^{95!}**
PR14065



- 1440 x 720 dpi w/smaller ink drops
- 6ppm black; 5ppm color
- USB compatible



KEYSPAN 4-port USB Hub

Only **\$49^{95!}***
w/iMac purchase
EX9556



- Provides 4 additional USB ports for expanding your peripherals.



*Apple iMac G3 and Keyspan USB hub must appear on the same invoice. While supplies last. Price for USB Hub without iMac purchase is \$69.95. Ask for item # EX9416.

NEW VERSION! CorelDRAW 8

As low as **\$99^{95!}***
SBN0104



An incredible collection of software for illustration, page layout, photo-editing, and more!

*Offer good when purchased with any Macintosh computer. Macintosh computer and CorelDRAW must appear on same invoice. Shipped in promotional packaging. Cannot be combined with any other promotional offers. Offer good while supplies last.



Equipped with the new **PowerPC G3!**
Furiously-Fast Processor

233MHz

- 233MHz PowerPC G3 processor
- Built-in 15" monitor with integrated stereo speakers and microphone
- 4.0GB hard drive
- 32MB SDRAM (256MB max.)
- 24X CD-ROM drive • 56K modem
- 512K backside level 2 cache
- 6MB VRAM • 10/100Base-T ethernet
- 2 high-speed USB expansion ports



Get an

for only **\$29^{99!}**
PER MONTH!

- ✓ Own an iMac computer for only \$29.99⁺ a month! (plus applicable taxes and shipping)
- ✓ No down payment! No payment due for 90 days!
- ✓ Instant approval within minutes! Call today to fill out a short application over the phone!



Your new Apple iMac G3 comes loaded with great software!

- ✓ AppleWorks
- ✓ Quicken Deluxe 98
- ✓ Microsoft Internet Explorer
- ✓ Netscape Navigator
- ✓ Microsoft Outlook Express
- ✓ Williams-Sonoma Guide to Good Cooking
- ✓ EarthLink Total Access
- ✓ Adobe PageMill
- ✓ Kal's PhotoSoap SE
- ✓ FAXstf
- ✓ Nanosaur
- ✓ MDK by Interplay
- ✓ EdView Internet Safety Kit

✓ Mac OS 8.5 software Included

iMAC GAMES BUNDLE

Get 5 great gaming software titles

FREE!*

when you purchase an Apple iMac G3.
Item # AAA0715

- Includes: You Don't Know Jack 2, Marathon, Solitaire Mania, Abuse and Video Casino



*Retail packaging shown for promotional purposes only. Shipped in promotional packaging on CD-ROM. Games Bundle must appear on the same invoice as iMac. Offer good while supplies last.

iMAC INTERNET BUNDLE

Get 5 great Internet software titles for only

\$49^{95!}*

when you purchase an Apple iMac G3.
Item # AAP0563

- Includes: Photodisc 75 Backgrounds & Objects for the Web, GoLive Personal Edition, Spring Cleaning, Cyber Patrol and Web Explosion



*Retail packaging shown for promotional purposes only. Shipped in promotional packaging on CD-ROM. Internet Bundle must appear on the same invoice as iMac. Offer good while supplies last.

EXTENDED KEYBOARD & MOUSE

Only **\$49^{95!}*** Save over \$50!***
w/iMac purchase
Ask for item # BND2908.



- Keyboard features quiet soft touch w/tactile feedback Keyswitch control
- Mouse features an excellent feel, shape, and 275dpi resolution



***Keyboard/mouse and iMac must appear on the same invoice.

AGFA SNAPSCAN 1212U SCANNER

As low as **\$99^{95!}*** MacWAREHOUSE Exclusive Offer! Save \$30!
Ask for item # IN7534.



- 36-bit color • 600 x 1200 dpi
- Scans up to 8.5" x 11.7"
- USB interface

*Price after \$30 MacWAREHOUSE mail-in rebate. Price before rebate is \$129.95. Ask for coupon # AA1297. Offer expires 12/31/98.

Microsoft MICROSOFT OFFICE 98

Full version **\$349^{95!}*** Save \$100!
as low as w/iMac purchase
Ask for item # BUS1150



*Price after Microsoft \$100 mail-in rebate when purchased with an Apple iMac G3. Price before rebate is \$449.95. Office 98 full version & Apple iMac must be purchased within 60 days of each other, between 8/1/98-12/31/98. Rebate coupon in iMac box.



on iMac add-ons!

• Imation • Farallon • DataViz • Metacreation • Broderbund

iMac G3

The iMac G3 is the all-in-one super-system that features a furiously-fast 233MHz G3 processor, built-in 15" monitor, 24X CD-ROM drive and integrated 56K modem for easy-to-use one-button Internet set-up and access!

The REALLY Fast, Fun, and Easy-to-Use Mac for ALL of us!

The New Apple® iMac™ G3 combines the excitement and challenge of CD-ROM gaming, the amazing sights and sounds of multimedia, and the virtually endless limits of worldwide Internet access – all wrapped in a new stunning all-in-one design! Everything about the iMac says “cool”: from the sleek lines of the translucent Bondi-blue case to its aerodynamic, un-cluttered appearance! Order yours today!

- Apple iMac G3 with FREE 64MB MEMORY Ask for item # CPU1261 \$1299.00
- Apple iMac G3 with FREE 64MB MEMORY INSTALLED Ask for item # CPU1262..... \$1328.95

Visit us at: **buymacgames.warehouse.com** for our full selection of great games for the Mac!



FREE* 64MB UPGRADE!

Instant memory upgrade to a total of 96MB from MacWAREHOUSE when you purchase an iMac today

for only **\$1299!**

HURRY! ACT NOW!

*\$29.95 installation fee applies. Limited time offer!

To learn more about the NEW Apple iMac G3 visit us at **imac.warehouse.com**

IMATION iMac SuperDisk USB Drive

Only **\$149^{95!}** DRI2793

- 120MB capacity
 - USB interface for easy plug and play, hot-swappable storage
 - Reads and writes 3.5" diskettes
- iMac Add-on!

FARALLON EtherMac iPrint Adapter

Only **\$109^{99!}** DEP1734

- Connects your iMac to LocalTalk printers and other Macintosh computers
 - Easy plug-and-play installation
- iMac Add-on!

BRODERBUND MYST

FREE! w/any purchase from MacWAREHOUSE AAA0593

- Challenge your puzzle-solving skills in the Island world that is Myst!

*\$3.95 shipping and handling applies. Shipped in promotional packaging. Hurry! Offer good while supplies last.

Painter 5.5 Web Edition

Only **\$199^{95!}** w/iMac purchase AAP0551 **Save \$100!** New Version!

- Image slicing tool • Dynamic editable text tool • Easy-to-use JavaScript rollovers • Assignable URLs
- *Apple iMac G3 and Painter 5.5 Web Edition must appear on the same invoice. While supplies last. Price for Painter 5.5 Web Edition without iMac purchase is \$299.95. Ask for item # GRA2708.

NEW! DataViz MacLinkPlus Deluxe v.10.0

Only **\$59^{95!}** w/iMac purchase AAP0545 **Save \$40!**

- Open, use, and convert files for the latest applications.
- *Apple iMac G3 and MacLinkPlus Deluxe must appear on the same invoice. While supplies last. Price for MacLinkPlus Deluxe without iMac purchase is \$99.95. Ask for item # COM1040.

Savings based on individual products sold separately as of this magazine printing.

IMAC FAMILY COLLECTION

4 great learning titles the whole family can enjoy for only **\$49^{95!}***

when you purchase an Apple iMac G3. Item # AAP0562

- Includes: Grolier Encyclopedia 98, Mavis Beacon Teaches Typing 5.0, PrintMaster Gold Suite, and Math Blaster Jr.



Retail packaging shown for promotional purposes only. Shipped in promotional packaging on CD-ROM. Family Collection must appear on the same invoice as iMac. Offer good while supplies last.

IMAC BATTLE BUNDLE

Get 5 great games for only **\$49^{95!}***

when you purchase an Apple iMac G3. Item # AAP0523

- Includes: Myth, Civilization II, Dark Forces, Tie Fighter and F/A-18 Hornet 3.0

*Retail packaging shown for promotional purposes only. Shipped in promotional packaging on CD-ROM. Battle Bundle must appear on the same invoice as iMac. Offer good while supplies last.



WHILE SUPPLIES LAST!

1-800-465-4090 ★ www.warehouse.com/md

ORDER TOLL-FREE 24 HOURS A DAY, 7 DAYS A WEEK!

CANADA ORDERS CALL: 1-800-603-5139

MacWAREHOUSE

The largest direct computer reseller in the U.S.!

EXPRESS DELIVERY OVERNIGHT!

In-stock items, call by midnight (E). Choose 150 at www.macworld.com/getinfo



Hi, I'm Sue. Call me for more great deals!

Surviving in a Windows world just got easier.



Upgrade to award-winning MacLinkPlus® Deluxe 10.0.

Being a Mac user in a Windows world can be a pain. But with MacLinkPlus Deluxe 10.0, it couldn't be easier. Just double click on a Windows file or use the sleek, new user interface and your pain is gone.

Translate the latest Windows files into Macintosh formats – or vice versa. Translate one file or a whole folder full of files at once. Files retain their original formatting.

Decompress files created using popular compression formats, including Stuffit, Compact Pro, Zip, Gzip and Z.

Get important information on selected files, such as file format, size, creation & modification dates.

Select a file or group of files to recognize, translate, decompress or view.

View files quickly, without opening the application that created them.



View the text of word processing and spreadsheet files without opening the original applications.

Select a folder for translated documents. Then open this folder and access translated documents with just one click!

Files with incorrect Types & Creators cause problems when double-clicked. Solve problems simply by clicking "Fix" then double-clicking the file to open it in the proper application.

The #1 selling survival kit for Mac users in a Windows world just got better. Isn't it great to know there's a software company as committed to Mac as you are?

For more information and to order, call 1-800-270-0030 ext.133.

Visit our Web site at www.dataviz.com/easier



Also available at fine retailers including:



Compatibility. Instantly.

© 1998 DataViz, Inc. All names are trademarks or registered trademarks of their respective companies.

Choose 102 at www.macworld.com/getinfo

Secrets

Keep Your Office Running Smoothly

WHAT TO DO WHEN OFFICE 98 MISBEHAVES

by Ted Landau

The buzz on Microsoft Office 98 has become a deafening roar of approval: Office 98 is a vast improvement over previous versions. But given the abundance of features, it's not surprising that the suite is still experiencing growing pains. If you're an Office user, or thinking of becoming one, learn how to protect yourself from the bugs you may encounter—before one of them bites you.

Remove Office 98 Goes Too Far

Problem If you want to uninstall Office 98, one of your options is to use a utility called Remove Office 98 (located in the Administration Tools folder). This program does a clean sweep, removing virtually all traces of Office 98 files from your disk. Unfortunately, it can get overzealous and move your entire System Folder to the Trash. According to Microsoft, this can happen only if an MS Library file named Microsoft Office 98 somehow winds up in the System Folder instead of in the Microsoft Office folder. Regardless, numerous users have run this utility and had their System Folders vanish before their eyes.

Solution Fortunately, only version 1.0 of the utility is prone to this disaster. More-recent copies of the Office CD-ROM ship with version 1.1, which fixes the bug. If you have version 1.0, be sure to download the 1.1 upgrade from Microsoft's Web site (see "Bookmarks").



PowerPoint Fails to Convert

Problem If you ever need to convert a PowerPoint 98 file to an earlier version of the program, simply selecting the appropriate translator from the pop-up menu in the Save dialog box should work. If your file is a relatively large one, however, you may get a "Memory full" error message when you try to convert the file.

Solution Surprisingly, increasing PowerPoint's memory (in the Get Info window) won't help. To get the conversion to work, you need to increase the memory of another utility, PP Translator 8-4 (which turns out to be the one that

does the actual conversion). You'll find it in the Translators folder (Microsoft Office 98: Office: Translators).

Word Refuses to Save

Problem Saving a Word 98 document usually works without a hitch. But Word may occasionally refuse to save your document, claiming you have too many files open. Mysteriously, Word 98 will stand by this claim even if the document you're trying to save is the only open file.

Solution Save the file in Word 6 for-

continues

mat. Next, quit Word 98 and reopen the document. You should now be able to save it in Word 98 format. This solution is less than ideal if the document contains formatting unique to Word 98 and that can't be converted, but at least it lets you save the text.

Since the problem seems to be related to the proliferation of work files Word creates when you repeatedly save an open document, turning off Word's Fast Save option should help. To do this, select Preferences from the Tools menu and then clear the Allow Fast Saves check box in the Save tab.

The Red X of Death

Problem Word 98's Insert Picture command lets you embed graphics in a Word document. The problem, particularly if the file contains several graphics, is that the images can suddenly disappear; in their place is a red X, dubbed by its victims "the Red X of Death."

Solution Whatever you do, don't save the file! If you do, all the graphics will be lost and you'll have to reinsert them. Instead, quit Word, select Get Info for the Word application, and increase the Preferred Memory size—give it as much as 30MB if you have enough memory. The X's are unlikely to reappear. (Microsoft is working on a permanent fix.)

Ê's Disappearing Act

Problem In Word 98, typing option-I followed by shift-E should produce a capital E with a circumflex mark over it (Ê, a character not often used in English but common in other languages). If you try

this, however, you'll probably get a space where the letter should be.

Solution Select Preferences from the Tools menu. From the Nonprinting Characters section of the View tab, deselect All (if it's selected), make sure Spaces isn't selected, and click on OK. The Ê should magically appear.

Word 98's Security Leak

Problem Open a Word 98 document in any text editor, such as Bare Bones' BBEdit (select Any File from the pop-up menu in BBEdit's Open dialog box to list Word files). Now scroll through the document. If your experience is typical, you'll find extraneous text that's invisible when you're viewing the document in Word. This text comes from other, usually deleted, files on your hard disk. Why worry about this? Because if you send these files to users who know how to make the extraneous text appear, you could be revealing confidential information.

Solution Microsoft's Office 98 Unwanted Data Patch squashes this bug. By the way, this problem isn't unique to Word; it can occur with any application that uses Microsoft's OLE (Object Linking and Embedding) technology, which allows applications to share data.

Contextual Menus Hide and Seek

Problem In Mac OS 8, you can access contextual menus by holding down the control key when you click the mouse. Office 98 has its own built-in contextual menus that override the Mac OS contextual menus that would otherwise appear. But if you've installed Contextual Menu

Enabler—an extension needed by some contextual-menu software, such as Apple Data Detectors—it trumps Office 98, and you're back to the Mac OS menus.

Bookmarks

Patches To download the Microsoft patches mentioned in this article, go to Microsoft's Known Issues Web page.

www.microsoft.com/macoffice/productinfo/issues.htm

And if you've moved up to the latest OS, you'll also want to download the Office 98 Updater for Mac OS 8.5.

www.microsoft.com/macoffice/85update.htm

Microsoft Support For other information on Office 98 problems, search Microsoft's Knowledge Base.

<http://support.microsoft.com/support/>

Beyond Microsoft if you can't find what you want at Microsoft's site, try one of the numerous independent Web sites, including my own MacFixIt.

www.macfixit.com

Solution If you want the Office 98 contextual menus but want to keep the Enabler installed (for use with other applications), go to the Help menu and select the Turn Off Contextual Menus option for the Office application. This option appears in the Help menu when you install Apple Data Detectors 1.0.2 or later. **m**

Contributing Editor TED LANDAU maintains the MacFixIt Web site (www.macfixit.com), where you'll find still more solutions to Office 98 problems.

Solving Office Extension Conflicts

OFFICE 98 PLACES MANY FILES IN THE SYSTEM Folder's Extensions folder (see "A Full Office"). Like anything else on your disk, these files can become corrupted, or installers for other applications that use some of the same files may replace them with newer or older versions. In either case, the result may be that Office applications no longer launch. If you can identify the likely problem file, you can use this generic fix.

1. Move the file from the Extensions folder in your System Folder to the desktop.
2. Delete the Microsoft Component Library file from the Extensions folder.
3. Start any Microsoft Office 98 program. The First Run install process begins, and the miss-

ing extension file is replaced with the uncorrupted version from Office 98.

A known instance of this problem involves Adobe Photoshop 5: it installs OLE Automation 2.06, which prevents Office 98 applications from working. One solution is to install Photoshop, move the Automation 2.06 file from the Extensions folder to the Photoshop folder, and then install Office 98.

If you've already installed Office 98, remove the OLE Automation and OLE Library files from the Extensions folder and then install Photoshop. Move OLE Automation 2.06 to the Photoshop folder, and launch Word 98 to get the First Run application to reinstall the removed files.

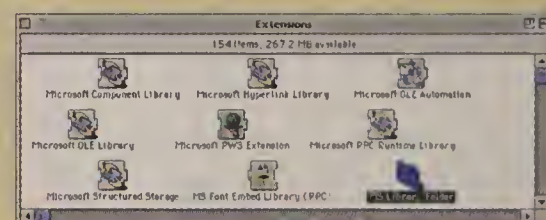
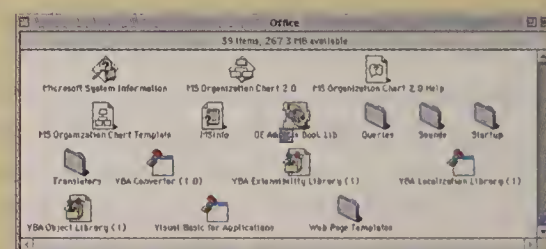

A Full Office Here's a peek at just some of the dozens of files and folders Office 98 installs.

| ANNUAL COVER PRICE | REGULAR SUBSCRIPTION PRICE | YOUR PROFESSIONAL ONE-YEAR RATE | BONUS STATUS |
|--------------------|----------------------------|---------------------------------|--------------------------|
| \$95.88 | \$34.97 | \$19.97 | MACWORLD CLIP ART CD-ROM |

As a Macintosh professional, you're entitled to a reduced rate on Macworld. Return this form now to get complete Mac OS coverage, and save up to 81% off the newsstand price. BONUS: MACWORLD CLIP ART CD-ROM -- FREE with your paid subscription.

Check one: 1 year (12 issues) for \$19.97 — **SAVE 79%** 2 years (24 issues) for \$35.97 — **SAVE 81%**

Name _____ (Please Print) _____ 4NKR4

Company _____

Address _____

City _____ State _____ Zip _____

E-mail _____

REPLY REQUESTED

RETURN THIS FORM TO GUARANTEE SAVINGS.

Payment enclosed. Bill me later.

Annual newsstand price \$95.88. Non US-orders, please add US\$20 postage; Canadian GST included. Your FREE CD-ROM will be shipped upon payment.

Check us out on the Web —
<http://www.macworld.com>



NO POSTAGE
NECESSARY
IF MAILED
IN THE
UNITED STATES

BUSINESS REPLY MAIL

FIRST-CLASS MAIL PERMIT NO. 66 BOULDER, CO

POSTAGE WILL BE PAID BY ADDRESSEE

Macworld[®]

Subscription Department
PO Box 54506
Boulder CO 80323-4506



Tips, Tricks, and Shortcuts

by Lon Poole

Do you want to save QuickTime movies via your Web browser but haven't yet paid for the \$30 QuickTime 3.0 Pro upgrade that makes this possible? If you use Netscape Navigator or Communicator and have QuickTime 3.0's standard Web plug-in, you can use several workarounds. Some readers suggest scrounging for the movie files in the Netscape cache folder, but Tobias Lee of London has a more direct procedure for Navigator 4.0 and Communicator 4.0.

After watching a QuickTime movie in Navigator or Communicator, choose Page Info from the View menu. A split window appears. The top pane lists URLs for all the images and movies on the Web page, and the bottom pane displays details about the listed items one at a time as you click on the URLs. In the top pane, locate the URL for the movie you want to save (it's labeled Embed, not Image) and click the adjacent URL to see details about the movie in the lower pane. In the lower pane, click the URL labeled Netsite to load the movie into the pane, and choose Save As from the File menu. Be sure to set the Format option to Source in the Save As dialog box. With default preference settings, Netscape saves the movie as a MoviePlayer file; you can then double-click the movie's icon in the Finder to open it with MoviePlayer.

If you use Navigator 3.0, you can use a similar procedure sent in by Paul Burney of Framingham, Massachusetts. After watching a QuickTime movie in the browser, choose Document Info from the View menu. In the top of the split window that appears, click the link for the movie and hold down the mouse button until a contextual menu appears. Choose Save

This Link As from the contextual menu, and be sure to set the Format option to Source in the Save dialog box.

Control Too-Speedy Scrolling

Q. My G3 Mac scrolls too fast. When I drag my cursor past the bottom of a ClarisWorks 5.0 spreadsheet window, hoping to scroll to cell A35, my computer flies to cell A134 before I can stop it. This also

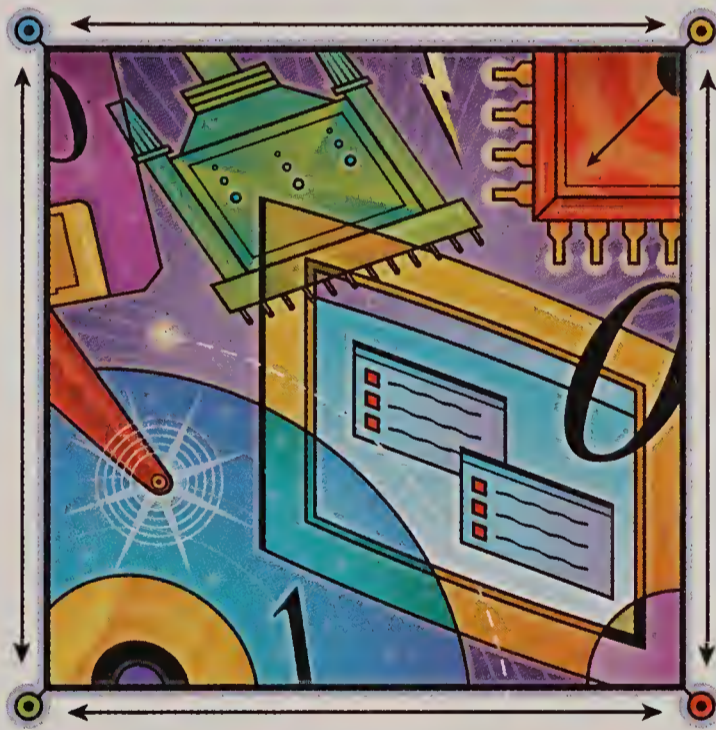

happens when I try to highlight text in a word-processor document. Is there any way to control my G3's scrolling speed?

ROBERT TRIEFF
Massillon, Ohio

A. The free Scrolling control panel by Ken McLeod (found on Ted Landau's MacFixIt Web site at www.macfixit.com/library/tul/scrolling.sit.hqx) lets you adjust how fast windows scroll and how quickly scrolling accelerates to the speed limit. It doesn't seem to affect scrolling in menus, however. Although this control panel has been around since 1991, it worked

fine in my brief tests with Mac OS 8.1. It does not work in Mac OS 8.5, however.

Test Your Phone Line

Q. When my 56-Kbps modem connects to the Internet, the connection speed is only 24 Kbps. I would like to get at least 38.8 Kbps, but I'm not sure whether the problem is my Internet service provider or my telephone line. How can I test my phone line to find out if it's the limiting factor?

MICHAEL O'LAUGHLIN
Breckenridge, Minnesota

A. You can test your telephone line by having a terminal program such as the freeware ZTerm or the communications module of ClarisWorks call 3Com's US Robotics BBS from your computer. You can find instructions for doing this on 3Com's Web site at www.3com.com/56k/need4_56k/linetest.html. If your phone line passes the test, then make sure the correct modem script is selected in your Modem control panel. Or if your Mac uses FreePPP or MacPPP for Internet connections, make sure the FreePPP Setup control panel or ConfigPPP control panel is configured properly for your modem.

Print from an iMac via LocalTalk

Q. I want to connect a 68040 Macintosh to my iMac. Since the iMac has only an Ethernet connection, do I need to buy an Ethernet card for the 68040 Mac? And once I get these

continues

babies connected, can I print from the iMac over my spiffy new network to a laser printer connected to my old Mac?

JIM LAVRAKAS
Anchorage, Alaska

A. You can connect the iMac and your old Mac via Ethernet (see *Quick Tips*, December 1998), but this network is separate from the LocalTalk network connection used by most laser printers. Although the Ethernet and LocalTalk networks both use the AppleTalk protocol, the Mac OS can connect via only one at a time.

Fortunately, you can *interconnect* the two different AppleTalk networks. One way is to install Apple's free LaserWriter Bridge control panel on your old Mac.

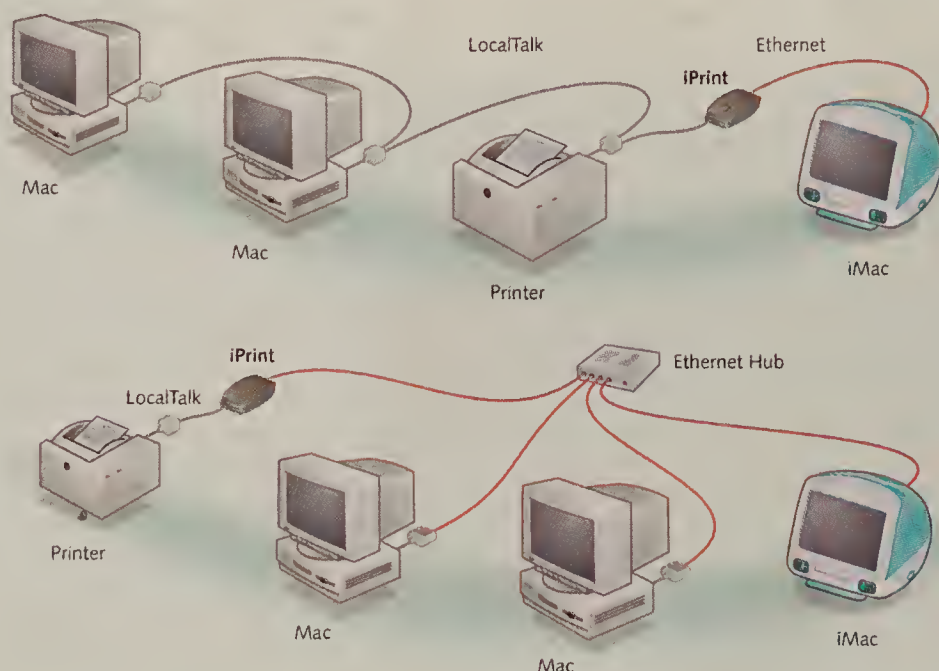

Printing via LocalTalk from an iMac If you use a Farallon EtherMac iPrint Adapter LT to connect an iMac to older Macs and a LocalTalk printer, you can either put all the computers on an Ethernet network (bottom) or put the old computers on a LocalTalk network with the printer (top). Using an Ethernet network gives you better file-sharing performance, but you need to buy a hub and Ethernet transceivers or adapter cards for some old Macs. Printing performance is the same with either option.

This allows the iMac and any other computers you might add to the Ethernet network to use the laser printer on the LocalTalk network, as long as the old Mac is turned on. But LaserWriter Bridge doesn't enable any communication between Macs on the LocalTalk network and computers on the Ethernet network. Apple's LocalTalk Bridge control panel enables computers on the two networks to share files and services, but it tends to sap the performance of the computer it's installed on.

You can avoid all the shortcomings of the bridge software with a device such as Farallon's \$99 EtherMac iPrint Adapter

LT. You simply connect the LocalTalk network and the Ethernet network to the iPrint, and then computers on either network can use printers, files, servers, and other services on the other network. The iPrint actually gives you a couple of network-connection options, as shown in "Printing via LocalTalk from an iMac."

Achieve Orderly Start-Up

TIP In "Work Less, Do More" (*Secrets*, October 1998), Joseph Schorr mentions putting program aliases into your Startup Items folder. To take this a step further, add a z to the beginning of the alias's name for the program

you want to use first after start-up, so it will be the last item to open. For instance, I usually check my e-mail first, so I renamed Eudora's alias zEudora.

DOUGLAS MEHR
Gurnee, Illinois

If the first program you want to use after start-up is one you expect to keep open longer than other start-up programs, put a second alias of it in the Startup Items folder. Name this alias 01, so your preferred program opens before the others. Then after all your start-up items open, the alias with the z should make your preferred program (already open) come to the front. If you leave this

program open and quit others, you're less likely to end up with fragmented memory (several small blocks of unused memory but no one block large enough to open another program).—L.P.

Track Installation with Labels

TIP To track the installation of control panels, extensions, and other items in the System Folder, I use the Finder's Labels feature. First, I assign a label to all items installed in the Control Panels, Extensions, and other special folders as part of the Mac OS installation. Each time I install new software, I know that the unlabeled items in these folders have been added by that software's installation. If no problem arises from the new items, I eventually give them a different label to distinguish them from newer items placed during the next installation.

DIETER KERSCHBAUMER
Olten, Switzerland

Keep Your Lap Cool

TIP Does your PowerBook overheat your lap? Since the day I got my PowerBook 1400, I've used it on a lap desk. Lap desks typically have a ledge to keep pens from rolling into your lap, which helps your PowerBook stay put, and some have a beanbaglike bottom that conforms to your lap. The flat desk surface supports your PowerBook's feet, ensuring an air-space underneath, and the beanbag bottom lets you position the desk comfortably.

JON C. HAVERSTICK
Santa Ana, California

LON POOLE answers readers' questions and selects reader-submitted tips for this monthly column. His latest book is *Macworld Mac OS 8 Bible* (IDG Books Worldwide, 1997).

All shareware and freeware mentioned in *Quick Tips* is available from the Macworld Online software library (www.macdownload.com).

We pay \$25 to \$100 for tips on how to use Macs, peripherals, or software. Please include your full name and address, so that we can send you your payment. Send questions or tips to quicktips@macworld.com or to Macworld Quick Tips, 301 Howard St., 16th Fl., San Francisco, CA 94105. All published submissions become the sole property of Macworld. Due to the high volume of mail received, we cannot provide personal responses. **m**

TOTAL ANNIHILATION™

The New Landscape of War!

The word is spreading across the map. Total Annihilation is poised to redefine real-time strategy games on the Mac.

Total Annihilation is a real-time war game featuring true 3D terrain and run-time generated 3D units. Tanks drive up and overhills, tilting and rocking with each bump in the landscape and impact with enemy weapons. Battle on diverse landscapes from lava worlds to vast island-dotted oceans. Build defenses high in the hills for a better view and a better shot. Planes bank and dive in intense air-to-air combat. Amphibious tanks drive into and dive underwater for surprise attacks.

Total Annihilation's 3D landscape is a revolution that demands deeper strategy and generates more realistic game play. Mobilize your forces and experience the new landscape of war!

Total Annihilation, winner of more than 50 awards worldwide is coming soon to the Macintosh.



Giant 3D environments
Challenging landscapes



Full complement of
land, air and sea units



More than 150 units
and 50 missions



Extensive multiplayer
and Internet support



Available soon at your local retailer, or visit the GT Interactive online store:
<http://www.gtstore.com> or call 800/229-2714

©1997 Humongous Entertainment, Inc. All Rights Reserved. Created by Cavedog Entertainment, a division of Humongous Entertainment, Inc. Distributed and published by MacSoft, an affiliate of GT Interactive Software Corp. Cavedog Entertainment™ and Total Annihilation™ are trademarks of Humongous Entertainment, Inc. All other trademarks are the property of their respective owners.

MacSoft®

An affiliate of GT Interactive Software Corp.
www.works.com/macsoft/

Choose 31 at www.macworld.com/getinfo

MOSCONE CONVENTION CENTER • MARRIOTT HOTEL

SAN FRANCISCO

JANUARY 4-8, 1999

THE HERE AND FUTURE NOW



Sponsored by:

Macworld

Owned & Produced by:

 **IDG**
WORLD EXPO

Managed by:

 **IDG**
EXPO MANAGEMENT
COMPANY

FOR A FULL EXHIBITOR LIST, UP-TO-THE MINUTE INFORMATION,
OR TO REGISTER, CALL **(800) 645-EXPO** OR VISIT:

www.macworldexpo.com

You've seen the reports from Silicon Valley to Wall Street—with increasing support from developers, vendors, and committed third parties.

For millions of computer users, Macintosh is synonymous with increased productivity and innovative technology advances. Come to San Francisco—home to a “think different” community—for the latest technologies and trends that will change the way you work, play, and learn now, and in the future.

At MACWORLD Expo/San Francisco, you'll demo, touch, see, and feel all the hot new products from over 400 leading vendors. Buy right on the show floor and enjoy show specials! Products and services centered around the iMac, PowerBook G3's, PowerMac G3 Desktops, QuickTime™ and much more! Learn time-saving productivity secrets through in-depth workshops and advanced and user-level conference programs. Hear from the brightest stars who are reshaping the future of the Mac universe at the much-anticipated keynote address.

YOU ARE INVITED TO ATTEND THE PREMIER EVENT FOR:

- *the Internet*
- *digital content creation, management, and delivery*
- *multimedia*
- *software development*
- *small business*
- *remote worker programs*
- *connectivity*
- *graphic design*
- *publishing*
- *education, research, and development*
- *home computing*
- *gaming*
- *entertainment*
- *new media professionals*

In today's fast changing “wired world,” it's a fact of life — Macintosh users lead the way into the creative markets, schools and the home while the others follow. Come to MACWORLD Expo/San Francisco to see what technologies, strategies and solutions the rest of the world will soon be using.

MACWORLD Expo/San Francisco is the largest Mac-focused event where you can see all the industry's leading vendors and latest innovations. There is no better opportunity to see, hear and learn so many ways to improve your productivity, business results and home computing experience. Look at all you can do at MACWORLD Expo/San Francisco:

- *The Mac OS is back! See the growing list of vendors supporting the industry's hottest new products and technologies. See, feel, and demo the latest products so you can make informed purchasing decisions about your Mac investments.*
- *With the successful introduction of the iMac and PowerMac G3's, new products are coming to the market at an unprecedented pace. Buy these products right on the show floor — at a discounted price!*
- *Enhance and update your creative skills, concepts and strategies by attending any of the dozens of conferences and workshops developed specifically for the individual needs of both Mac professionals and consumers. Grow your business and enhance your Mac experience!*
- *Hear the very latest news and industry buzz before it hits the streets by attending our keynote sessions and conferences.*
- *Network with other Mac professionals to share ideas and insights on getting the most from the iMac and other high-performance G3 products.*

- **TOWN MEETING:**
January 4, 1999
- **PRE-CONFERENCE WORKSHOPS:**
January 4, 1999
- **KEYNOTE ADDRESS:**
January 5, 1999
- **EXHIBITS:**
January 5-8, 1999
- **Macworld/Pro CONFERENCE:**
January 5-7, 1999
- **MACWORLD EXPO USERS CONFERENCE:**
January 6-8, 1999

REGISTER BY DECEMBER 4 AND SAVE!

SAVE \$100 ON PACKAGE 1:
Full Package (ALL Macworld/Pro and MACWORLD Expo Users Conference Sessions)

SAVE \$100 ON PACKAGE 2:
Pre-Conference Workshop & All Macworld/Pro Conference Sessions

SAVE \$100 ON PACKAGE 3:
All Macworld/Pro Conference Sessions

SAVE \$50 ON PACKAGE 4:
MACWORLD Expo Users Conference Sessions & Pre-Conference Workshop

SAVE \$25 ON PACKAGE 5:
All MACWORLD Expo Users Conference Sessions

SAVE \$50 ON PACKAGE 6:
Pre-Conference Workshop

SAVE \$16 ON PACKAGE 7:
MACWORLD Expo Exhibits

All packages include admission to the exhibit floor. Please refer to the registration page for complete package descriptions.

TAKE ADVANTAGE OF THESE SAVINGS!

**COMPLETE AND RETURN THE
REGISTRATION FORM TODAY!**

Or go to:
www.macworldexpo.com
to register.

more ▶

Industry Leaders Speak Out!

KEYNOTE ADDRESS:

The Macintosh industry is one of the most exciting and fast-moving places to be these days. What are the trends that will shape the industry in the year ahead? What are the technologies to keep an eye on? Hear the insights and predictions of the people who are moving the industry forward at the MACWORLD Expo keynote address. MACWORLD Expo is traditionally the place where the news is made—don't miss this opportunity to hear it first!

Tuesday, January 5, 9:00 a.m. - 10:00 a.m. at the Marriott Hotel

TOWN MEETING:

MACWORLD Expo Conference attendees are invited to attend this opening session of MACWORLD Expo/San Francisco. Hosted by conference chairperson Paul Kent and Mac industry stalwart Bob LeVitus; come and hear experts from all corners of the Mac community speak on a variety of subjects. The MACWORLD Expo Town Meeting features lectures, debates, performance, cool demos and interactive discussions.

Monday, January 4, 9:00 a.m. - 11:30 a.m.



PRE-CONFERENCE WORKSHOPS

**Monday, January 4, 1999:
12:00 p.m. – 7:00 p.m.**

Make the most of your time at MACWORLD Expo/San Francisco. Take advantage of this unique opportunity to spend an entire day getting in-depth training before the conferences and exhibits begin. Full workshop session descriptions are posted on the Web at: www.macworldexpo.com.

- [WA]** Practical Introduction to Mac Networking
- [WB]** Designing Web Pages with Dynamic HTML
- [WC]** Desktop Publishing: The Big Picture
- [WD]** Creation of High Quality Photographic Web Content
- [WE]** Essentials of Web Publishing
- [WF]** Putting Internet Commerce to Work
- [WG]** Optimizing AppleShare IP in the Integrated Network Environment
- [WH]** Macintosh Network Administration with the Apple Network Administrators Toolkit
- [WI]** Introduction to Content Asset Management
- [WJ]** Workflow Automation with AppleScript

Special Interest Environments

ON THE MACWORLD EXPO EXHIBIT FLOOR

January 5-8, 1999

EDUCATION DISTRICT

The newly expanded Education District will showcase software, Internet tools, curriculum building solutions and multimedia for schools, training and home learning. Bursting with new applications, hardware, and real-world solutions from leading developers and solutions providers, the Education District will bring you new ways to enhance classroom learning.

APPLE DEVELOPER CENTRAL

Come see the latest applications, custom solutions, multimedia, scientific and engineering solutions for the Macintosh. Annually Developer Central is one of the very best resource centers where software developers can find the tools and solutions they need to grow their companies and reduce development time and costs.

CONSUMER APPLICATIONS AT HOME

Consumer Applications at Home will be the premier showcase for digital entertainment and consumer applications created for home use. Supported by Apple Computer, this exciting area will deliver hands-on demonstrations, solutions, and real-life business models for consumer applications, appliances and entertainment content.

EXTENSIONS WORKSHOP FOR CREATIVE CONTENT

The Extensions Workshop is the showcase for the most popular desktop publishing, multimedia and pre-press applications. Its bound to be a major attraction at MACWORLD Expo! Join the World-Wide Power Company and XChange NA in demonstrating and reviewing cutting-edge extensions designed to help you create and publish compelling content.

MACINTOSH GAMING CHAMPIONSHIP & EXHIBITIONS

Showcasing the latest gaming titles and environments for the iMac and other Mac products, the Macintosh Gaming Exhibitions is a high-energy interactive area to get your hands-on today's hottest games. Featuring the ultra-successful National Macintosh Gaming Championship and retail store, you will have the opportunity to demonstrate, compete, and buy the latest Mac game titles.

Check out www.macworldexpo.com regularly for updates and announcements about other new special attractions on the MACWORLD Expo show floor, including areas dedicated to QuickTime™, Internet server and application development tools, video streaming and content asset management.

THE CONFERENCE PROGRAM

Macworld/Pro Conference • MACWORLD Expo Users Conference

Macworld/Pro

The Technical Conference for Macintosh Professionals

January 5 - 7, 1999

Get in-depth, advanced technical training at MACWORLD Expo by participating in the Macworld/Pro Conference. Improve your skills, meet other Mac professionals with similar challenges and stay on top of your profession. The Macworld/Pro Conference is designed for:

- Webmasters, Content Creators, Web Entrepreneurs, Web Developers
- Network Managers, Network Administrators
- Support Professionals
- Developers
- Mac Platform Managers from Business, Government and Education
- IS/IT/MIS Managers
- Educators

Participate in these sessions led by a faculty of world-class instructors and lecturers and take your computing efforts to the next level. You'll emerge from this conference with enhanced skills and a wealth of new information. Here's what you can expect.

Macintosh Networking & Communications

This track presents techniques and technologies associated with deploying Macintosh LANs, WANs, Internet/Intranets and remote access. These technical sessions take you inside the protocols and services you will encounter when using Macs on a network.

Sessions Include:

- Open Transport Update – the Macs on TCP/IP Report
- Tuning Open Transport
- On the Trail of Network Problems
- High Speed Connection Alternatives – Which is Best for You?
- Building a Mac-Centric Intranet
- ... and more

Creative Track 1

This track hosts several theme days of education for creative professionals. "PDF Day" goes inside the world of the Portable Document Format and reveals how you can mass distribute documents to users and ensure consistent viewability. "Managing New Media Businesses Day" offers sage advice and practical tips for competing in

the hot new media creative world. "Publishing Automation Day" offers 3 solution filled sessions for optimizing publishing workflow processes to save you time and money.

Sessions Include:

- Introduction to PDF
- PDF in the Real World
- Color Management: Digital Proofing
- Pub Auto: Working in RGB
- Pub Auto: Taking Content In-House
- ... and more!

Creative Track 2

The second Creative Track features full days of courses for professional Webmasters, Digital Video and Broadcast pros, and some fascinating and informative sessions about Content Asset Management. Attend these sessions and you will go inside these hot areas and discover new means to enhance your skills.

Sessions Include:

- Web Day: Understanding and Applying XML
- Web Day: Top 20 Tips for Webmasters
- Video Day: Producing Interactive TV for WebTV
- Video Day: Production for Digital Broadcast
- Content Management: Web-Based Content Management
- ... and more!

Creative Track 3

Creative Track 3 offers a comprehensive curriculum of Color Management courses. Learn how to insure color from source through delivery in these hot, timely and cutting edge sessions. The track is rounded out with a series of practical sessions on Pre-Flighting, Web Audio and QuickTime™ that will provide excellent advice on these ground breaking technologies.

Sessions Include:

- Color Management: ColorSync Workflow
- Color Management: Deploying Color Servers
- Create Biz: Issues in Running a Web Design Agency
- Pre-flighting or How to Save \$400 at the Service Bureau
- Delivering Audio on the WWW
- ... and more!

Managing the Mac Platform

The Macintosh continues to be a platform in transition. Environments that deploy Mac OS and related technologies are being forced to evolve along with the platform. It is now more critical than ever to approach Mac systems management methodically no matter what size your organization.

Sessions Include:

- Managing Your Hardware Assets
- Software License Compliance
- Backup Planning and Disaster Recovery
- Planning the Next Generation Mac
- Technical Overview of USB
- ... and more!

MACWORLD Expo Users Conference

January 6 - 8, 1999

Learn from the professionals about how to use your Mac at work, at home, at school and on the road by participating in this conference program.

Maxing Your Mac

Put your Macintosh in full throttle and squeeze every bit of performance out of it. Whether you're working with an old Mac or the latest fully loaded model, you'll get a lot of sound advice and useful tips from experts.

Sessions Include:

- Connect your New iMac to Your Old Stuff
- Fabulous Powerbook Speedups
- How to Get the Most from Your iMac
- Mysteries of the System Folder Revealed – Part I & II
- Troubleshooting - Unlikely Solutions
- ... and more!

The MACWORLD Expo Gallery

Creative people have always chosen the Macintosh as the best tool for turning their vision into reality. This track features renown artists from around the Mac community demonstrating their dazzling works and explaining how they used Mac-based tools to achieve their stunning success. See why the Macintosh is still the premiere environment for bringing creative ideas to life.

Sessions Include:

- 3D Techniques
- Making Beautiful Music: The Macintosh Musician
- Ho-Hum to WOW in 60 Seconds Flat
- How'd they do that (with Adobe Illustrator!)
- Creative Macintosh Layout Techniques
- ... and more!

Crash Courses

Need to get the scoop on the latest technology? Want to get up to speed with the hottest tools? Attend our Crash Courses for a quick hit of technology explanations to help make you a more informed Macintosh user.

Sessions Include:

- Getting Started with Digital Photography
- Getting Setup for the Internet
- Other Uses on the Mac
- Your First Web Page
- How the Internet Works
- ... and more!



more ►

FOR A COMPLETE EXHIBITOR LIST, UP-TO-THE MINUTE INFORMATION,

OR TO REGISTER, CALL (800) 645-EXPO

OR VISIT:

www.macworldexpo.com

THE CONFERENCE PROGRAM

Macworld/Pro Conference • MACWORLD Expo Users Conference

Top Tools

Extend your mastery of a variety of Mac tools by attending these power-user sessions. Whether you're wondering how to get more out of the tools you use every day or learn what a new tool can do for you, these sessions will unlock the secrets of your favorite programs and get you up to speed quickly with advanced features you didn't know were available.

Sessions Include:

- Advanced Filemaker Techniques
- Just Flash It!
- Better HTML
- Hot Quark Tips and Tricks
- Digital Wizardry with Photoshop
- ... and more!

Apple Technology Tutorials

Inside your Macintosh are some of the most advanced and innovative system technologies available on any computer platform. Gain in-depth understanding of these technologies, learn why they're special.

Sessions Include:

- Introduction to QuickTime™ 3.0
- Understanding ColorSync
- Secrets of AppleScript Wizard
- Mac OS Update
- Setting Up a LAN with AppleShare IP
- ... and more!

Center Stage

We've invited some of the luminaries from the Mac community to share their visions, educate, entertain and enlighten you in these sessions. On Center Stage you'll gain new perspectives from some of the most progressive thinkers in our industry.

Sessions Include:

- How to Be a Mac Power User
- Renegade Publishing
- How to Ruin the Internet
- Delivering on the Promise of the Web: Making Everyone a Desktop Publisher
- ... and more!

Small Office/Home Office (SOHO)

It's never been easier or more fun to use Macintosh technology to launch and operate a small company, home-based business or to telecommute from your home office. Learn from experts how to put technology to work for you painlessly to create a lean, mean business machine.

Sessions Include:

- Putting Your Small Business on the Web
- Be a Mac Office—Even if Your Clients are on Windows!
- Telecommuting Essentials
- Small Business Intranet Instruction Kit: Part I and II
- Macintosh Telephony for Small Business
- ... and more!

For Educators Only

The Macintosh paradigm for computing ease-of-use has made it the platform of choice for educators world-wide. This track showcases innovative applications and techniques that can enhance both learning and teaching opportunities in your school.

Sessions Include:

- A Taste of Apple Staff Development
- Practical uses of QuickTime™ in Education
- ... and more!

Macworld Magazine Presents

Macworld's editors, columnists and featured guest speakers present the hottest topics straight off the pages of the industry's premier publication.

Sessions Include:

- Macworld Magazine's Presents Vision Thing Live
- Macworld Magazine's Presents Newsmakers... A Candid Discussion
- Macworld Magazine's Best of Show
- Ask the Experts
- The Game Hall of Fame
- The Best of Macworld Magazine's Mac Secrets
- ... and more!

Goodies

These light-hearted sessions are just for fun! Come join fellow members of the Macintosh user community as we celebrate technology in this wild, weird and wonderful track.

Sessions Include:

- Better Living Through Home Electronics – Gadgets
- Palm Pilot & Macintosh – A Match Synched in Heaven
- The Game Gurus
- Home Networking for the Two Computer Family
- Sports on the Internet
- ... and more!

Travel Made Easy & Convenient!

Travel to MACWORLD Expo/San Francisco Made Easy and Convenient!

Early booking is strongly advised to ensure best hotel selection. Hotel reservations will be assigned on a first-come first-served basis based on availability. Rates shown are per night, per room, and do not include room tax, currently 14% San Francisco occupancy tax. After December 1, 1998 the convention rate may not apply.

Air Reservations: Exclusive discounted fares are available to San Francisco, San Jose and Oakland airports via United Airlines and Delta. A MACWORLD Expo travel professional can assist you with access to these fares or you may contact the airlines directly utilizing the MACWORLD Expo discount numbers below. Additionally, your travel agent may utilize these discount numbers and receive the same low fares.

UNITED: (800) 521-4041 #525XR

DELTA: (800) 241-6760 #DMN119486A

Responsibility and Liability:

Convention Housing Management (CHM) and IDG Expo Management Company, travel program sponsor, and/or their agents act only in the capacity of agents for customers in all matters pertaining to hotel accommodations and transportation whether railroad, motor car, airplane, or any other means, and as such are not responsible for any damage, expense or change in schedule or condition from any loss, injury or damage to any person or property from any cause whatsoever. Baggage handling throughout the program is entirely at the owner's risk. The customer agrees that IDG Expo Management/CHM shall not be held responsible in the event of any errors or omissions in any promotional material.

Convention
HOUSING
Management

Please contact:

Convention Housing Management

for travel inquiries:

**1700 The Alameda, 2nd Floor,
San Jose, CA 95126.**

**Telephone: (800) 799-9914
within the United States or
(408) 918-4200 outside of
the United States.**

Fax: (408) 918-4250

Email: macworld@chmrooms.com.

www.macworldexpo.com

MACWORLD EXPO / SAN FRANCISCO ADVANCE REGISTRATION FORM

1. REGISTRATION SELECTION AND FEES (SELECT ONE ONLY)

DEADLINE FOR SAVINGS IS DECEMBER 4!

All Conference and Keynote Sessions are on a first-come, first-served basis, with the exception of the Pre-Conference Workshops. Please choose your package and fill out the form completely. Incomplete forms will be returned. Please use one form per person; make photocopies for additional people.

Early Discount Registration
on or before 12/4/98 via phone, www, fax or mail
\$895

Regular Registration
(12/5/98-12/30/98)
via phone, www or on-site
\$995

- Package 1 – SUPER PASS (Jan. 4-8)** **\$895** **\$995**
Includes: Pre-Conference Workshops • Lunch (Mon. only) • Keynote Presentation • Macworld/Pro Conference Sessions • MACWORLD Expo Users Conference Sessions • Exhibits • Town Meeting
W (Write in your Workshop selection code– see list on page 3 of ad. Forms without workshop selection will be returned.)
- Package 2 – Macworld/Pro and Pre-Conference Workshop (Jan. 4-7)** **\$795** **\$895**
Includes: Pre-Conference Workshop • Lunch (Mon. only) • Keynote Presentation • Macworld/Pro Conference Sessions • Exhibits • Town Meeting
W (Write in your Workshop selection code– see list on page 3 of ad. Forms without workshop selection will be returned.)
- Package 3 – Macworld/Pro Conference (Jan. 5-7)** **\$595** **\$695**
Includes: Macworld/Pro Conference Sessions • Keynote Presentation • Exhibits • Town Meeting
- Package 4 – MACWORLD Expo Users Conference and Pre-Conference Workshop (Jan. 4-8)** **\$395** **\$445**
Includes: Pre-Conference Workshop • MACWORLD Expo Users Conference Sessions • Lunch (Mon. only) • Keynote Presentation • Exhibits • Town Meeting
W (Write in your Workshop selection code– see list on page 3 of ad. Forms without workshop selection will be returned.)
- Package 5 – MACWORLD Expo Users Conference (Jan. 6-8)** **\$170** **\$195**
Includes: MACWORLD Expo Users Conference Sessions • Keynote Presentation • Exhibits • Town Meeting
- Package 6 – Full-Day Pre-Conference Workshop (Jan. 4)** **\$295** **\$345**
Includes: Pre-Conference Workshop • Lunch (Mon. only) • Keynote Presentation • Exhibits • Town Meeting
W (Write in your Workshop selection code– see list on page 3 of ad. Forms without workshop selection will be returned.)
- Package 7 – Exhibits ONLY (Jan. 5-8)** **\$29** **\$45**
Includes: Admission to the Exhibits ONLY. Does not include admission to the Keynote Presentation or Town Meeting



**Moscone Convention Center
SAN FRANCISCO**

- Pre-Conference Workshop: Jan. 4
- Town Meeting: Jan. 4
- Keynote: Jan. 5
- Macworld/Pro Conference: Jan. 5-7
- Exhibits: Jan. 5-8
- MACWORLD Expo Users Conference: Jan. 6-8

- Conditions and Policies:**
- Payment must accompany form for registration to be complete.
 - Purchase orders not accepted.
 - Fax and mail registrations received after Dec. 4 will be returned unprocessed.
 - This form cannot be used for on-site registration.
 - All registration fees are non-refundable and credentials are non-transferable.
 - A \$20 fee will be charged for all returned checks.

2. CUSTOMER INFORMATION

First Name _____ M.I. _____ Last Name _____

Title _____

Company _____

Street Address (please include apt. #, suite, mail stop, etc.) _____

P.O. Box (if applicable) _____

City _____ State/Province _____ Zip Code/Postal Code _____

Country _____ Telephone _____ Extension _____

Fax _____ Internet/Email Address _____

DEADLINE!

PLEASE READ!

- The Deadline for all fax and mail registrations is Dec. 4. All fax and mail registration received after this date will be returned.
- You may still register at regular prices via Web or phone from Dec. 5 - Dec. 30.
- If you register between Dec. 5 and Dec. 30, you MUST pick up your badge on-site at the On-Site Badge Pick-Up Counter.
- All international (including Canada) attendees must pick up badge on-site at the On-Site Badge Pick-Up Counter.
- Confirmation of registration will be sent once registration is processed. Pre-registration deadline is December 4, 1998
- U.S. Badges will be mailed after December 22 for registrations received through 12/4/98.
- Workshops and Conference Sessions are subject to change. Check our web site frequently for updates: www.macworldexpo.com
- On-Site Registration Hours:
January 4: 8:00 a.m.- 4:00 p.m.,
January 5-7: 8:00 a.m.- 6:00 p.m.,
January 8: 8:00 a.m.- 4:00 p.m.

3. ATTENDEE PROFILE

MUST BE FILLED OUT TO PROCESS YOUR BADGE.

WHAT IS YOUR INDUSTRY? (CHECK ONE ONLY)

| | | |
|--|---|--|
| <input type="checkbox"/> 1. Accounting/Finance | <input type="checkbox"/> 18. Printing/Publishing | <input type="checkbox"/> 31. Educator |
| <input type="checkbox"/> 2. Aerospace | <input type="checkbox"/> 19. Transportation | <input type="checkbox"/> 32. Engineering/Scientific/R&D |
| <input type="checkbox"/> 3. Architecture/Construction/Process Industries | <input type="checkbox"/> 20. Utilities | <input type="checkbox"/> 33. Human Resources |
| <input type="checkbox"/> 4. Art/Design/Creative Services | <input type="checkbox"/> 21. Other _____ | <input type="checkbox"/> 34. Management/Department Head |
| <input type="checkbox"/> 5. Arts & Entertainment | | <input type="checkbox"/> 35. Marketing/Sales |
| <input type="checkbox"/> 6. Computer Reseller/VAR/VAD/Service | FOR WHAT PURPOSE ARE YOU PURCHASING/ EVALUATING PRODUCTS AND SERVICES? | <input type="checkbox"/> 36. Network Management |
| <input type="checkbox"/> 7. Consulting | <input type="checkbox"/> 22. For My Company/Organization/Department | <input type="checkbox"/> 37. Professional (Lawyer, Doctor, etc.) |
| <input type="checkbox"/> 8. Education: K-12 | <input type="checkbox"/> 23. For Myself as Consultant/Sole Proprietor | <input type="checkbox"/> 38. Programming/Analysis |
| <input type="checkbox"/> 9. Education: Higher Ed | <input type="checkbox"/> 24. For myself as Consumer | <input type="checkbox"/> 39. Purchasing |
| <input type="checkbox"/> 10. Education: Other | WHAT IS YOUR JOB FUNCTION? (Check One Only) | <input type="checkbox"/> 40. Software Developer |
| <input type="checkbox"/> 11. Engineering/R&D | <input type="checkbox"/> 25. Art Director/Graphics | <input type="checkbox"/> 41. Training |
| <input type="checkbox"/> 12. Government/Military | <input type="checkbox"/> 26. Consultant | <input type="checkbox"/> 42. Other _____ |
| <input type="checkbox"/> 13. Health/Medical Services | <input type="checkbox"/> 27. Controller/Treasurer/Accounting/CFD | WHAT IS THE SIZE OF YOUR ORGANIZATION? |
| <input type="checkbox"/> 14. Legal Services | <input type="checkbox"/> 28. Corporate Executive | <input type="checkbox"/> 43. Under 50 |
| <input type="checkbox"/> 15. Manufacturing (Computer Industry) | <input type="checkbox"/> 29. DP/IS Management/CIO | <input type="checkbox"/> 44. 50-99 |
| <input type="checkbox"/> 16. Manufacturing (Non-Computer Industry) | <input type="checkbox"/> 30. Editorial/Writing | <input type="checkbox"/> 45. 100-499 |
| <input type="checkbox"/> 17. Marketing Sales/PR/Communications | | <input type="checkbox"/> 46. 500-999 |
| | | <input type="checkbox"/> 47. 1000 & Over |

WHICH PERSONAL COMPUTERS DO YOU USE?
(Check all that apply)

| |
|---|
| <input type="checkbox"/> 48. Macintosh Powerbook Series |
| <input type="checkbox"/> 49. Macintosh Performa Series |
| <input type="checkbox"/> 50. Macintosh Quadra Series |
| <input type="checkbox"/> 51. Macintosh Workgroup Series |
| <input type="checkbox"/> 52. PowerMac |
| <input type="checkbox"/> 53. iMac |
| <input type="checkbox"/> 54. PowerMac G3 |
| <input type="checkbox"/> 55. PowerBook G3 |
| <input type="checkbox"/> 56. IBM PC or compatible desktop |
| <input type="checkbox"/> 57. IBM Laptop/Notebook |
| <input type="checkbox"/> 58. Other _____ |

ARE THE COMPUTERS AT YOUR ORGANIZATION NETWORKED?
 59. Yes 60. No

PRIORITY CODE

MWJ

4. PAYMENT METHOD

(YOU'LL BE CHARGED FOR ALL REGISTRATIONS RECEIVED INCLUDING DUPLICATES.)

IMPORTANT Payment must accompany form for registration to be complete. **DON'T PAY TWICE FOR THIS EVENT!** You will be charged for all registrations received, and will not be refunded for duplicate registrations. Please use one method of registration only.

- Check enclosed (make payable to MACWORLD Expo). Enclose check and form in an envelope.
- Master Card Visa American Express Amount \$ _____

Account Number _____ Expiration Date _____

If card holder is other than registrant, please print card holder's name below:

First Name _____ M.I. _____

Last Name _____ Card Holder Signature _____

REGISTER NOW!

Use ONE of the following methods to register with this form:

- Phone:** 800-645 EXPO or 781-551-9800 outside of the U.S. (\$5 Service fee does apply) **THROUGH DEC. 30.** Registrations received after 12/4 will be charged at regular pricing.
- Web:** www.macworldexpo.com **THROUGH DEC. 30.** Registrations received after 12/4 will be charged at regular pricing.
- Mail to:** MACWORLD Expo /San Francisco P.O. Box 9103, Norwood, MA 02062-9103. **THROUGH DEC. 4 ONLY.**
- Fax:** 781-440-0359. Faxed registration form must include credit card information **THROUGH DEC. 4 ONLY.**
- (TTY) Service is available for the hearing impaired. **Dial 781.440.0366.**



Publishers/
Communicators

Printers/
Prepress

Web
Producers

Content/
Creative

The publishing revolution returns to Boston.

Hynes Convention
Center • Boston, MA

3 Main Conferences
March 1-5, 1999

Special Interest
Days/Tutorials
March 1-5, 1999

3-Day Exposition
March 2-4, 1999

See print and Web publishing technologies that will give you and your organization new competitive life, creative liberty and the pursuit of increased profit. Seybold Seminars, now back in Boston, offers you three focused conference programs that will give you the edge you need: Publishing Strategies provides senior management the insight to harness today's new technologies for improved business advantage; Best Practices for Publishing Workflows enables both printers and publishers to

master the latest digital technologies; and Web Publishing looks in-depth at the tools, techniques and visions driving the Web. Plus our unparalleled 3-day publishing technology exposition will arm you with the firepower to colonize new territories. For your FREE Expo Pass and Advance Program Guide, call or visit our Web site before 2/18/99.

SEYBOLD SEMINARS BOSTON
PUBLISHING 99

free pass | www.seyboldseminars.com if by Web | 888.800.8922 (+1.781.433.1665) if by phone



A Strong Batch of DeBabelizer

Tips for Automating the Ultimate Image-Manipulation Utility

by Jim Heid

Today's designer wears more hats than a millinery model. In addition to producing printed materials, you might also be involved in Web-site and CD-ROM projects. Where graphics and images are concerned, each medium has its own unique requirements—color catalogs need high-resolution images, for instance, while Web sites need fast-downloading ones. These disparate requirements probably force you to spend more time than you'd like just converting files. Open a high-resolution TIFF file, shrink it down for the Web, save it as a JPEG; rinse and repeat.

But there is a way to automate this grunt work. Designers and multimedia producers have long sworn by Equilibrium's DeBabelizer, the ultimate graphics-manipulation and file-conversion utility. DeBabelizer can open and save every major graphics file format and most of the minor ones. It lets you apply quality-optimized color palettes, tweak brightness and contrast, crop and resize, and much more. Best of all, you can automate these processes and apply them to an entire collection of images.

But before swearing by DeBabelizer, many designers find themselves swearing at it. It's ironic that visually oriented people must rely on a program that can be ugly and awkward, has cluttered dialog boxes, and makes you use the Open command to delete a file.

DeBabelizer's beauty lies beneath its rough exterior, and the best way to break through that exterior is in small steps. What follows is a road map for mastering the product's automation features, with a sidebar ("Put Your File Conversion on Autopilot") showing how to tackle a common conversion scenario.

The DeBabelizer Difference

All image-editing programs can convert between file formats, resize images, and reduce bit depth; many also have batch modes that let you automate these tasks. So why grapple with a program as arcane as DeBabelizer?

For one, DeBabelizer's ability to create custom color palettes is unmatched. Even better, the utility can examine a collection of images and create a single color palette that best reflects their colors. You can then apply this SuperPalette to the images.

DeBabelizer also excels at *dithering*, the process of combining colored dots in patterns to simulate other hues. Dithering is an essential part of the bit-depth-reduction process, and DeBabelizer offers more control over dithering

than any image editor.

What's more, while the batch features in image editors are limited to manipulating the contents of a single folder, DeBabelizer's autopilot can transcend a single folder and even a single computer. You can, for instance, set up a drop folder on a file server, and then tell DeBabelizer to monitor that folder so that whenever anyone tosses an image into it, a batch process executes. This can be a boon to large shops where several designers are working on their own sets of images.

Unlike image editors, DeBabelizer also supports conditional processing: you can specify that a task be performed only if certain conditions are true. The sidebar shows this capability in action; it details

continues



Put Your File Conversion on Autopilot

HERE'S A COMMON SCENARIO THAT SCREAMS FOR DEBABELIZER'S batch-processing talents: You've just finished producing a lavish four-color catalog. Now you need to adapt its images for use on the Web and for your company's sales force to plop into presentations and word processing documents. For the Web, you'll need to convert

your original, high-resolution TIFF images into JPEG format. You'll also need to lighten the images slightly so they display well under Windows, where images appear darker than on Macs.

What's more, you'll want to create a thumbnail version of any image whose horizontal dimension is wider than 300 pixels; on the final Web site, you'll link these thumbnails to their larger counterparts. Finally, you'll need color PICT files. Here's how to make it all happen.

1 Set up your folders.

Create three folders to hold the final, converted images: JPEG Files, Thumbnail JPEG Files, and PICT Files.

2 Set up a batch list.

DeBabelizer's BatchList window lets you set up lists of files to be converted. There are several ways to add files to a batch list, but the easiest is to open the folder containing the files, select the files, and then drag them to the BatchList window.

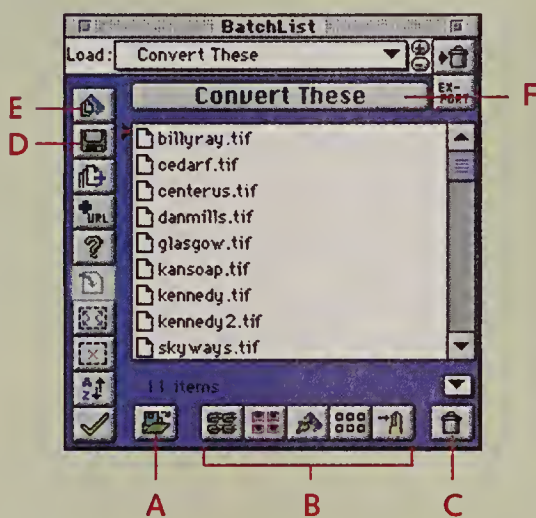

- A Opens the files in this batch list.
- B Performs batch-automation operations on those files.
- C Removes the selected file(s) from the batch list.
- D Saves this batch list.
- E Creates a new batch list.
- F Allows you to rename the batch list.

3 Create an automation script.

The most complex part of any DeBabelizer automation chore is deciding which approach to take and testing that approach.

For this project's rather complex requirements, we'll create a single script named Convert Files. Choose Script from the Window menu, then click on the New Script button (C) to clear the Script window's contents and create a new script. Name the new script Convert Files. (You can apply the Convert Files script to a single image by dragging the image's icon from the Finder to the Script window's target button, the small bull's-eye. This is a handy way to convert and scale just one image.)

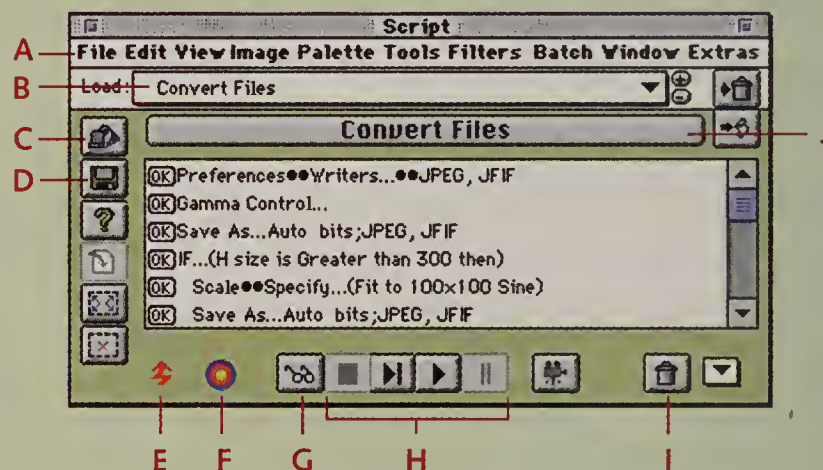

- A Menu of commands you can add to the script.
- B Switches between scripts.
- C Clears the script window.
- D Saves the script.

how to set up the program so it automatically creates a thumbnail version of any image whose horizontal dimension is larger than 300 pixels.

Choosing an Automation Option

Fleshing out a DeBabelizer batch-processing job is a form of programming. You don't actually peck out lines of program code, but you do have to apply the same logical, stepwise thought processes—thinking through what you want to accomplish and then determining the best approach.

DeBabelizer offers several batch-processing options that can be combined

in various ways. One of the challenges behind automating the utility is choosing the right mix of options for the job.

Batch Automation Eight built-in automation routines can handle the most common format-conversion and image-manipulation tasks. If you need to convert between file formats, create custom color palettes, or generate contact sheets containing thumbnail versions of images, the Batch menu's Batch Automation command should be your starting point.

Scripts A *script* is a series of commands that DeBabelizer executes in sequence, much like a set of Actions in Adobe Photoshop. But DeBabelizer

scripts pack far more automation power, including supporting IF-THEN operations that execute only when certain conditions are true.

You can create scripts by using the Script window to insert statements manually via the mini menu bar. But an easier way is to use the voyeuristically named WatchMe feature, which records your actions and saves them as a script. This is a terrific way to create simple scripts and to flesh out the overall structure of complex ones.

ProScripts DeBabelizer ships with a collection of canned scripts that perform common tasks, such as mapping a

- E Action arrow—drag it to the BatchList window's Open button to apply the script to the batch list, or drag to an open image's window to apply the script to the image.
- F Target button—drag an image's icon to this button to apply the script to the image.
- G Turns WatchMe mode on and off.
- H Controls script playback.
- I Deletes the currently selected script line(s).
- J Allows you to rename the script.

4 Add some commands.

To insert the script's commands, use the mini menu bar at the top of the Script window. After inserting a command, you must double-click on its name in the Script window to specify the command's settings. For example, after inserting the Gamma Control command, double-click on it to specify the gamma settings you want to apply.

Here's a guide to each of the script's key areas, along with some details on how to set them up.

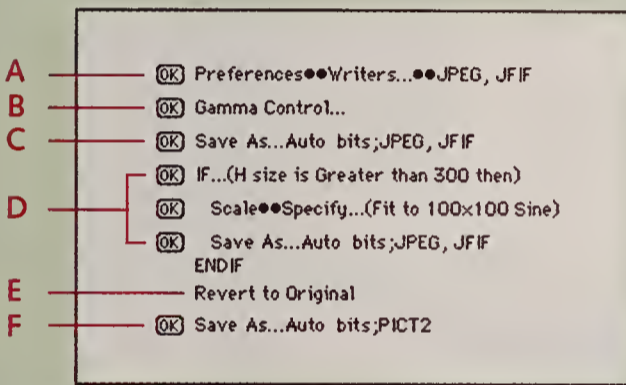

- A Controls the desired quality setting for the JPEG images. To add this command, use the Script window's mini menu bar to choose JPEG, JFIF from the Writers submenu, which is within the Preferences submenu of the File menu (whew!). In the JPEG Save Options dialog box, be sure to click in the Skip Dialog check box so this command's dialog box doesn't appear every time a new image is opened.

collection of images to the Netscape color palette and then saving them as GIF files. These ProScripts live in a folder named DeBabelizer 3 ProScripts; to use them, you must import them into DeBabelizer via the Import command in the File menu's Import/Export DeBabelizer Resources submenu.

AppleScripts DeBabelizer also supports the Mac OS's scripting language, AppleScript. You can save completed DeBabelizer scripts in AppleScript form and modify them to automate not only DeBabelizer, but other programs as well. You might, for example, create a script that converts a series of images for the

Web and then uses Fetch to send them to a service provider.

Developing an Automation Style

As you work with DeBabelizer's batch-processing features, you'll find there are often many paths to the same end. Should you write a script and then execute it within the Batch Automation window? Or should you use a script to execute a particular Batch Automation routine? Or do you forgo Batch Automation entirely and use WatchMe to handle the entire project?

As a general rule, look to the Batch Automation window first. It can handle

- B Specifies the gamma correction you want to apply to the image. I used 1.2, but you'll want to experiment to find the best value for your images.
- C Saves the gamma-corrected images in JPEG format. When double-clicking on this command, use the resulting Save dialog box to specify the JPEG format and the destination folder (in this example, the folder named JPEG Files).
- D Scales the image down if its horizontal dimension is greater than 300 pixels. The indented commands within this IF-THEN statement execute only if the condition is true.

To insert the If statement, choose IF from the Script window's Extras mini menu, then double-click on the If statement and configure its dialog box as shown.

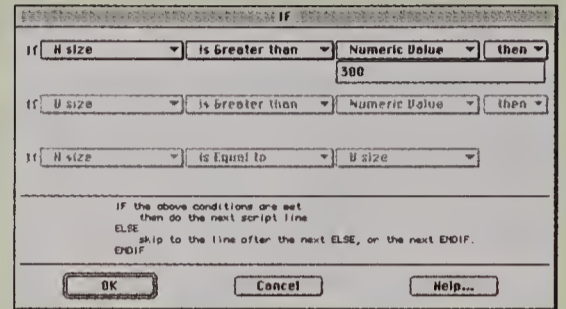

For the Scale command, use the Fit Into Size action to maintain the image's original aspect ratio. For the Save As command, specify the JPEG format and the folder named Thumbnail JPEG Files.

After inserting and tweaking these commands, end the IF-THEN statement by choosing ENDIF from the Script window's Extras mini menu.

- E Reverts to the original image in preparation for the final step.
- F Saves the image as a PICT file. The destination folder is PICT Files.

After you've created the script, click on the Script window's Save icon.

5 Apply the script.

To apply the script to the batch list, drag the action arrow to the BatchList window's Open button, then sit back and relax while DeBabelizer crunches through each image.

the most common conversion and manipulation jobs. If you need an extra measure of batch-processing power—IF-THEN tests, for example—then try writing a script and executing it within a Batch Automation routine.

In the end, there's often no right or wrong way to approach a batch-processing chore. What counts is that you succeed in automating the tasks at hand—and that you get home sooner than if you didn't have DeBabelizer. **m**

A contributor to *Macworld* since 1984, JIM HEID (www.beidsite.com) writes and lectures on Web and multimedia development tools and techniques.



Publishers/
Communicator

Printers/
Prepress

Web
Producers

Content/
Creative

The publishing revolution returns to Boston.

Hynes Convention
Center • Boston, MA

3 Main Conferences
March 1-5, 1999

Special Interest
Days/Tutorials
March 1-5, 1999

3-Day Exposition
March 2-4, 1999

See print and Web publishing technologies that will give you and your organization new competitive life, creative liberty and the pursuit of increased profit. Seybold Seminars, now back in Boston, offers you three focused conference programs that will give you the edge you need: Publishing Strategies provides senior management the insight to harness today's new technologies for improved business advantage; Best Practices for Publishing Workflows enables both printers and publishers to

master the latest digital technologies; and Web Publishing looks in-depth at the tools, techniques and visions driving the Web. Plus our unparalleled 3-day publishing technology exposition will arm you with the firepower to colonize new territories. For your FREE Expo Pass and Advance Program Guide, call or visit our Web site before 2/18/99.

SEYBOLD SEMINARS BOSTON
PUBLISHING 99

free pass | www.seyboldseminars.com if by Web | 888.800.8922 (+1.781.433.1665) if by phone

Bring Buttons to Life in Flash 3

Animate Your Rollover Buttons with Actions and Movie Clips

by Katherine Ulrich

Like rats in a lab, computer users—from gamers to Web surfers—know what to do when they see a button: click on it and wait for something to happen. With Macromedia's Flash 3, a tool for creating vector-based animations, designers can create buttons that give users not just rewards but also real control over multimedia and Web environments.

In the filmmaking metaphor of Flash's interface, you place objects and elements on a stage, make frame-by-frame animations in a timeline, and create scenes. When you're done, you export your work as a movie. Flash buttons let users control the finished film by starting and stopping playback, going to a specific frame, and switching scenes.

But buttons are more than a mechanism for moving viewers from place to place; they can contain their own animations and form the foundation of sophisticated interface elements, such as pull-down menus. If you've already mastered the fundamentals of creating Flash movies, it's time to bring your buttons to life.

Button Basics

To make a button in Flash, you first create an object called a *symbol*, a reusable element stored in a movie's library. You can modify the color, brightness, transparency, and other attributes of a symbol each time you use it, but Flash downloads the basic graphic just once.

Creating a button is similar to creating a regular Flash movie: you work with objects on a stage and frames in a time-

line, and you change the look of those objects by using keyframes (see "Build a Basic Button"). But where regular movies may have hundreds of frames that play sequentially over time, buttons have four frames that play in response to certain mouse actions. The first three correspond to the three possible button states: Up (nothing is going on; the button is just sitting there waiting for someone to notice it), Over (the mouse has moved into the button area), and Down (the user has clicked on the button). The fourth frame, Hit, defines the boundary of the button.

Although it's invisible to the end user, any solid graphic in the Hit frame becomes the active trigger for the button in the final movie. The Hit graphic can be

continues

Build a Basic Button

To get a grip on how buttons work, jump right in and make your own simple button. You'll need to create a new button symbol, then add graphics to its Up, Over, Down, and Hit frames.

- 1 Choose Insert: Create Symbol (F8). In the Symbol Properties dialog box, enter a name, select the Button behavior, and click on OK to enter Edit Symbols mode.

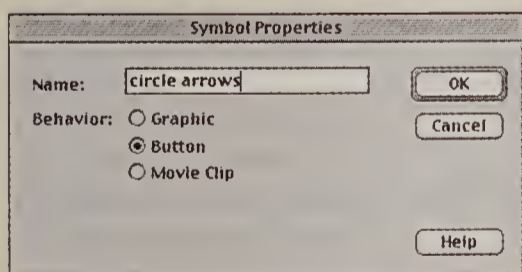

- 3 Use a different graphic in each frame to give users feedback about the button. The Hit-frame graphic should be big enough to cover the graphics in the other button states (turn on onion skinning to check); this Hit-frame graphic needs to be enlarged.



Hit-frame graphic

- 2 The button timeline has just four frames: Up, Over, Down, and Hit. By default, Flash puts a keyframe in the Up frame; you must add keyframes to place graphics in the Over, Down, and Hit frames. Click and hold in a frame to bring up the Frame menu.

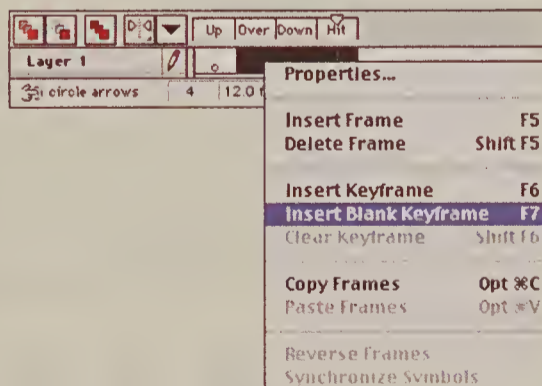

- 4 To see the button in action, choose Edit: Edit Movie, drag a copy from the library to the stage (the visible area of your Flash movie), and select Control: Enable Buttons. The button is now live, changing as you move the mouse over it and click on it.

TIP Another way to preview a button is to select it in the Library window and click on the Play button (the right-pointing arrow at the top of the window).

Animated Buttons Starring Movie Clips

AT THE HEART OF ANIMATED ROLLOVER BUTTONS IN FLASH LIE MOVIE CLIPS. The process of making a movie clip is very similar to that of creating any animation in Flash; the difference is that you start by creating a symbol. Here, we'll create a simple animation that transforms an oval into a starburst.

1 Choose Insert: Create Symbol (F8), enter a name, and select the Movie Clip behavior. Click on OK, and Flash brings up a new timeline and stage.

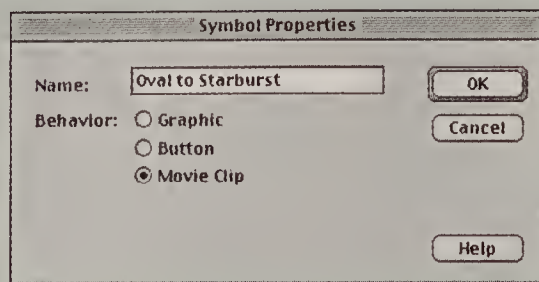

2 The status bar (A) displays the name of the symbol being edited; the filmstrip icon means that this symbol has movie-clip behavior. Select frame 5 in the timeline and choose Insert: Blank Keyframe (F7).



3 Place the oval in frame 1 of layer 1 and the starburst in frame 5. Turn on wireframe onion skinning (B) to help position the objects. Note: Shape tweens require that the beginning and ending objects sit directly on the stage. If you're working with a grouped object or symbol, select it and choose Modify: Break Apart (⌘-B). (You may need to repeat the command several times until all components are at the stage level.)

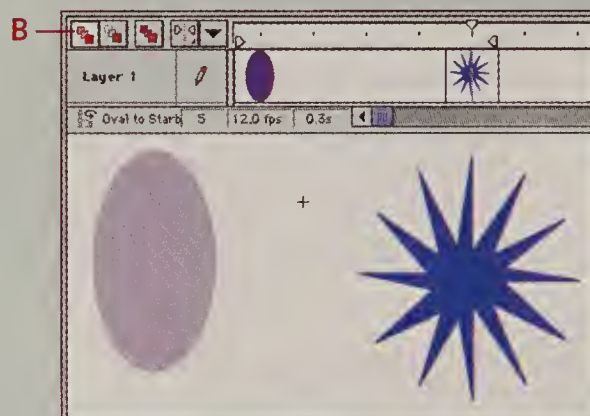

4 Double-click on frame 1 to bring up Frame Properties. In the Tweening tab, select Shape tweening and the blend type Distributive (for rounded shapes) or Angular (for shapes with corners). The default Easing setting keeps the rate at which the shapes transform consistent.

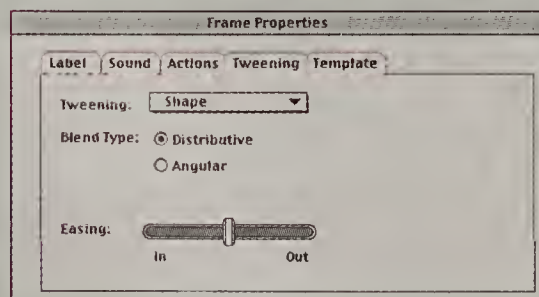

5 Click on OK, and Flash creates the in-between frames necessary to animate this morphing oval. Press return to watch the animation.

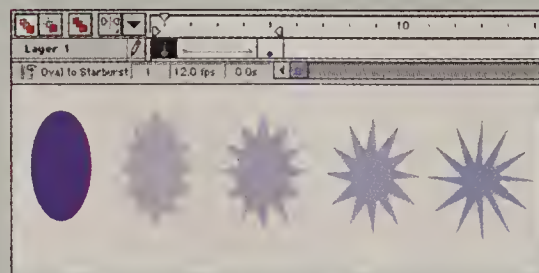

6 Choose Edit: Edit Movie to return to Edit Movie mode. Create two more movie clips. Now follow the steps in "Build a Basic Button," but this time place movie-clip symbols in the first three frames. (Check out www.macworld.com/more/ for a step-by-step tutorial on building a fully animated button.)

a copy of the Up, Over, or Down graphic; you can also draw a shape enclosing all the elements that make up the button and then fill the shape with color. You can even draw a shape that doesn't touch the Up, Over, and Down graphics at all. For example, an invisible square in the lower right corner of the stage could trigger a circular button that appears in the upper left corner.

Button Feedback

We humans are like lab rats in another way: we rely on visual cues to tell us what constitutes a button. In a straightforward informational site, a button might look like something from the real world—say, a light switch or a volume knob. In more-whimsical sites or games, buttons might be camouflaged as part of the scenery. As the mouse moves over such a button, a slight change in appearance or the triggering of a sound might be the only indication of the graphic's dual purpose.

Flash 3's button symbols make it easy to provide visual feedback; you simply use a different graphic for each of the button states. Flash also lets you associate sounds with individual button frames. For buttons that emulate real-world switches or toggles, you can attach a clicking sound to the Down frame to add realism. For more-fanciful buttons, you might add sound to the rollover frame to alert users to the location of an interactive element.

Buttons on the Move

To move beyond static three-frame buttons, you need Flash's movie-clip symbols—looping, self-contained animations that play within a single movie frame. Place a movie clip in the Up frame of a button, and you've got an animation that responds to the user's mouse.

You can vary the animations slightly for each button state or change them completely. For example, a blinking question mark might start to spin when the mouse rolls over it; clicking on the button might make the question mark change color or shape. The trick lies in creating a different movie clip for each frame of the button (see "Animated Buttons Starring Movie Clips").

Movie clips are really mini Flash movies; they can contain all the elements of a regular movie. You can nest movie clips inside other movie clips

and even nest buttons within movie clips. Because they loop continually within a single movie frame, you can use movie clips to create buttons that stay animated even when the movie containing them is paused.

Buttons in Action

Besides looking lively, buttons should do something. To make buttons work, you need to assign them *actions*—embedded commands that control such things as starting and stopping movie playback, going to a specific frame or screen, or linking to a specified URL (see “Actions Put Buttons to Work”).

You can assign actions to frames as well as to buttons. In the case of frames, Flash executes an action as soon as the movie reaches the frame containing the action. Buttons, however, respond to mouse events. That’s why buttons offer one action not available to frames—On MouseEvent—which lets you define the precise mouse movement that triggers the button’s actions. Note that you must attach actions to an instance of your button (a copy used in a movie), not to the frames that make up the button symbol itself.

To override the default On MouseEvent option, Release, select another parameter in the Actions tab of the Modify Instances dialog box. Press responds to the downward part of a click when the mouse is over a button. Release Outside responds when the user clicks the mouse inside the button area but then moves the mouse outside before letting go. Roll Over responds to the cursor’s rolling into the button area; Drag Over responds to the cursor’s moving into the button area while the mouse button is down. Roll Out responds to the cursor’s moving out of the button area; Drag Out responds to the cursor’s moving out while the mouse button is down.

Give Buttons a Whirl

The best way to get a handle on buttons is to build some yourself. Start with a simple, static button that looks different in each state, then add movie clips and actions. With a little practice, you’ll soon be building buttons that amaze even the most jaded multimedia rats. **m**

KATHERINE ULRICH is a freelance writer and editor living in San Francisco.

Actions Put Buttons to Work

HOW DO YOU GIVE USERS MOUSE CONTROL OVER A FLASH MOVIE? ADD ACTIONS to your buttons. By definition, buttons always respond to certain mouse events: move the mouse into the button area and Flash displays the Over frame; click on the button and Flash displays the Down frame. You can make buttons respond to other mouse events by adding actions and setting the parameters of your choice.

- 1 Select an instance of the button on the stage and choose Modify: Instance (⌘-I). In the Actions tab of the Instance Properties dialog box, click on the plus sign and select On MouseEvent from the pop-up menu.

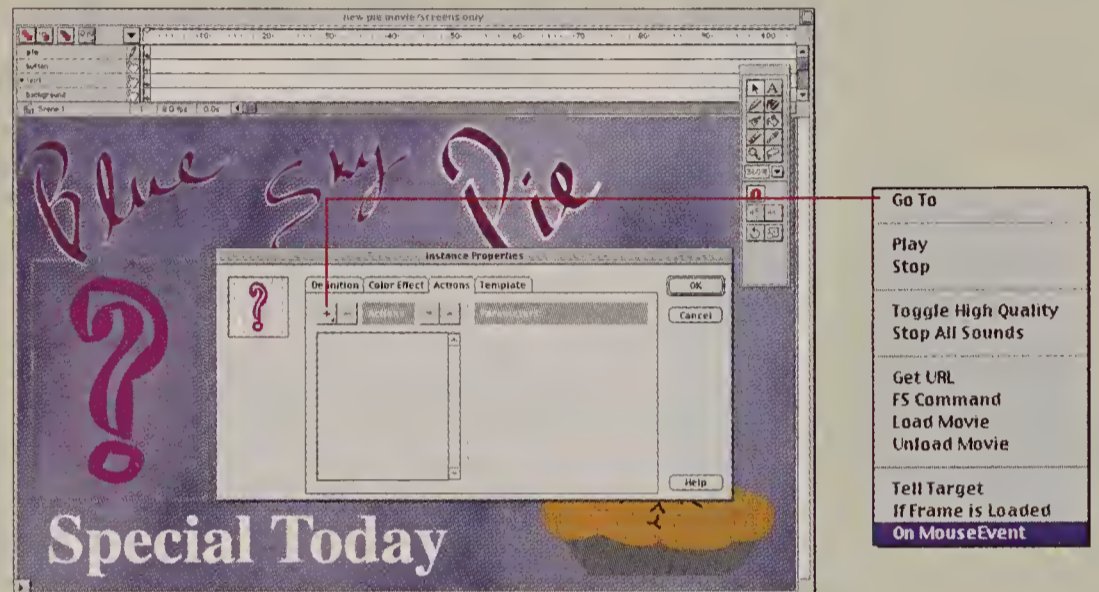

- 2 Select a mouse event under Parameters. You can set multiple parameters for a mouse event—for example, to make the button respond to rollover as well as drag over.

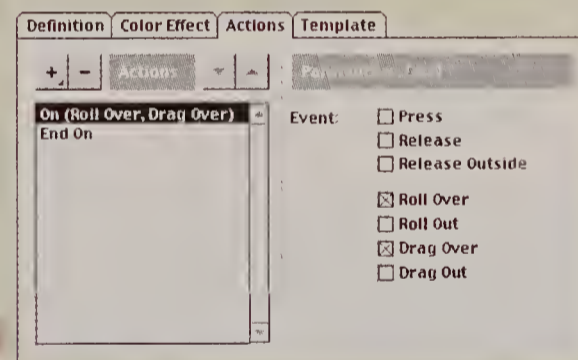

- 3 Once you’ve set up the On MouseEvent parameters, click on the plus sign again to choose the action the button will carry out. Stringing actions together allows the button to respond differently to different mouse events. For example, On (Release) might take you to the next scene in the movie, whereas On (Drag Out) loads a movie that displays a help window. A single mouse event can also trigger several actions—for example, moving to another frame or scene in the current movie and then loading a second movie.

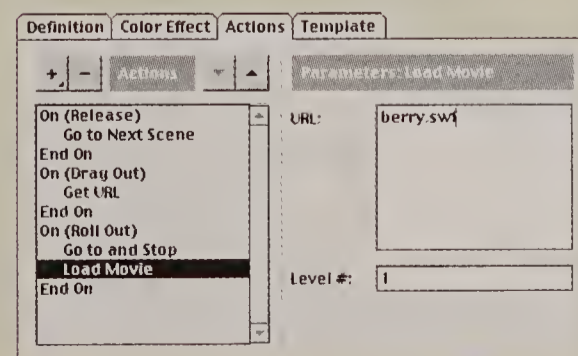

©1998 Iomega Corporation. Iomega, iomega, and Jaz are registered trademarks of Iomega Corporation. Photoshop is a registered trademark of Adobe Systems, Inc. Prices listed are estimated street prices. Actual prices may vary.

LOST

IMPORTANT PHOTOSHOP FILES 1.6 GB

Project goes by the name "Atlas"

MUST FIND BY 11/18/98

Any information, call
Chuck "Dead Meat" Martin

415-781-3400



It's not just your work. It's your life.

Keep it safe on the Jaz[®] 2GB drive and disks. It's the fastest performing Jaz drive with twice the capacity as the original. And it works with the millions of Jaz 1GB disks already out there. 2GB drives now priced as low as \$349. Disks as low as \$99. Find a dealer near you or buy online at: www.iomega.com



iomega.

Choose 103 at www.macworld.com/getinfo

Mastering Adobe Premiere 5

Expert Tips and Techniques for Commanding a Video-Editing Powerhouse

by Jim Heid

Some premieres are more successful than others. Just ask the producers of *Waterworld*—and of Adobe Premiere 5.0. The long-awaited upgrade of this veteran video-editing program packs professional-level features and a greatly enhanced interface (see *Reviews*, September 1998). But in a world of innumerable system configurations and dozens of different video-capture cards, Premiere 5.0 didn't always play to rave reviews. The program's debut was marred by some bugs and performance problems—and by incompatibilities with many third-party video-capture cards (see “Surviving Premiere's Flaws”). Adobe addressed some of Premiere 5.0's problems with the 5.1 update (www.adobe.com), but we'll help you navigate through the sticky points that remain.

Despite its flaws, Premiere is still a video-editing powerhouse. To take full advantage of its considerable capabilities, make it a point to learn and apply Premiere's shortcuts and timesaving features. Version 5.0 sports more of these goodies than did earlier versions, and you'll find guides to the best of them in “Taking Charge of the Monitor Window” and “Timeline Tricks.” Unless otherwise noted, all processes apply to both the Mac and Windows versions of Premiere. Speaking of which . . .

Crossing the Platform Divide

Now that Premiere 5.1 and QuickTime 3 are available for the Macintosh OS and Windows alike, it's easier than ever to set up a multiplatform editing shop. You can move Premiere 5.1 projects between platforms, but to ensure a smooth journey, keep the following tips in mind.

File Carefully It's a good idea to stash all the files a given project requires in a single folder. This makes it easier to move the project's assets between platforms. When you open the project on the destination platform, Premiere will dis-

play an Open dialog box and ask where the project's assets are located. Navigate your way to the folder containing the first file that Premiere is looking for, and then click on OK. Because you put all the files in the same place, Premiere will automatically locate the rest.

It's also a good idea to name files with cross-platform compatibility in mind. Specifically, be sure your Mac projects end with the .ppj file extension—that's how the Windows version of Premiere identifies project files. And if your network software truncates long file names, you might want to stick with the old-fashioned eight-by-three naming convention: a maximum of eight characters in a file name, with a three-character extension.

Kill the Previews Remove preview files before transferring a project from one platform to another. To delete all preview files, press and hold ⌘-option-shift (Ctrl-Alt-Shift on PC keyboards). Next, move your pointer to the work-

area bar on the Timeline window. When the mouse pointer turns into a small trash icon, click the mouse. Then save your project and send it packing to the other platform.

Use the Right Codec For both your source clips and your project, be sure to choose a compression scheme that's available on both platforms. Cross-platform codecs include Component Video, Sorenson Video, and Cinepak, all of which are available in QuickTime 3 Pro.

It's too bad that Premiere 5.0 shipped with some bugs and that some third-party capture-card vendors have dragged their feet in releasing Premiere 5-compatible drivers. But while Premiere 5.0 may have been heckled at its debut, it's still a powerful player with a bright future. And that's more than the producers of *Waterworld* can say. **m**

JIM HEID (www.heidsite.com) has been working with Adobe Premiere since version 1.0 shipped.

continues



Taking Charge of the Monitor Window

THE MONITOR WINDOW IS A CORNERSTONE OF PREMIERE 5'S enhanced user interface. Premiere's new look-and-feel mimics that of high-end video-editing workstations, thanks in large part to the program's side-by-side Source and Program views; the former harbors individual clips, while the latter houses your whole project. You can now quickly assemble projects, using primarily the Monitor window and its battery of buttons.

Instant Inserts

In previous versions, inserting one clip in the middle of another was a multistep process. In Premiere 5, it takes just a couple of clicks: with the new clip visible in the Source view (A) of the Monitor window, position the Timeline window's edit line (see A in "Timeline Tricks") where you want the insertion and then click on the Monitor window's Insert button (F). Premiere 5 splits the clip that the edit line bisects and inserts the new clip at that location.

Quick Cutaways

When you use the Insert button, Premiere 5 pushes anything to the right of the edit line forward in time, extending the length of your project. But if the clip you're inserting is a two-second cutaway—say, a shot of an interviewer nodding her head in agreement to an answer—you'd want the cutaway to *replace* two seconds' worth of the clip to the right of the edit line. In cases like this, add the new clip by clicking on the Overlay button (E) instead of the Insert button.

All the Trimmings

When you need an extra measure of editing precision, switch the Monitor window into trimming mode by pressing ⌘-T

(Ctrl-T on PC keyboards). In trimming mode you can fine-tune cuts down to the single-frame level.

Quick Editing

The Monitor window makes fast edits easy. Rather than drag a clip to the Timeline window, simply use the buttons for setting the clip's in and out points (H and G, respectively) and then drag the clip from the Source view (A) to the Program view (B).

Opening Clips in Separate Windows

If you prefer to open a clip in its own window as you could in earlier versions of Premiere, press option (Mac) or Alt (PC) while double-clicking on a clip in the Project or Timeline window. Clicking on the collapse button (C) separates the controllers from the playback windows, enabling you to position each separately.

TIP If you have an NTSC monitor connected to your computer, you can instantly move the Source and Program images to the NTSC monitor by pressing ⌘ (Mac) or Ctrl (PC) while clicking on either image.

TIP If you collapse the Monitor window, you can quickly resize the Source and Program images by shift-clicking on either image.

Taking Shortcuts

Each of the Monitor window's buttons has a handy keyboard shortcut: (E) Overlay, comma; (F) Insert, period; (G) Set clip's out point, O; (H) Set clip's in point, I.

TIP Here are some undocumented keyboard shortcuts for the Monitor window's transport controls (D): press L to play a clip, K to stop playback, and J to play in reverse.

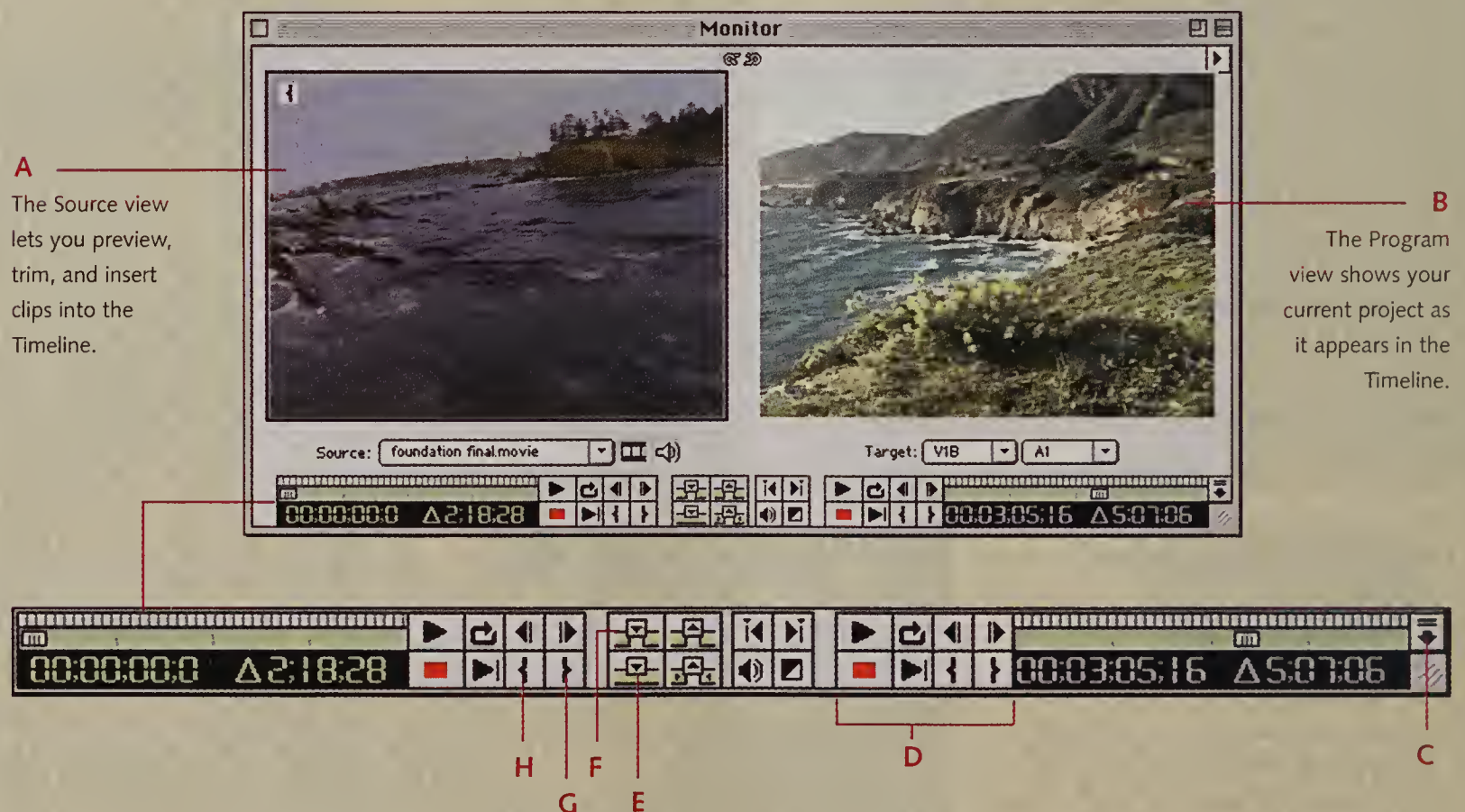

Surviving Premiere's Flaws

IF YOU'RE USING PREMIERE 5, YOU MAY FALL VICTIM TO one or more of the following "issues." Here are some ways to get around them.

Frequent Crashes upon Launch

This could be caused by a corrupted font; try removing fonts until you isolate the flawed one.

Frequent Crashes as You Work

There's a good chance that your video-capture card isn't compatible with Premiere 5. Adobe changed Premiere's underlying architecture in ways that require capture-card developers to create new versions of their drivers. The rule is simple: if Adobe hasn't certified your capture hardware as being Premiere 5-compatible, don't upgrade to Premiere 5. How do you determine whether your capture hardware is Premiere 5-compatible? Check with its developer or check the compatibility matrices on Adobe's Web site at www.adobe.com/prodindex/premiere/resources.html#matrices.

Frames Dropped during Capture

To avoid dropping video frames during captures, ensure that your Mac's CPU is devoting all its attention to Premiere. Disable AppleTalk, choose LocalTalk in the Network control panel, and insert media (floppies, CD-ROMs, Zip cartridges) in all of your removable-media drives. Also, disable any extensions that talk to the CPU extensively; examples are screen savers and calendar or timer extensions. And follow the usual rules of video capturing: capture to your fastest hard drive, and defragment that drive before capturing.

Performance Is Slow as Molasses

Premiere 5, particularly the Mac version, is no speed demon. Some operations, such as performing a ripple delete or inserting a clip near the beginning of a large project, are downright plodding. The 5.1 update addressed a few performance problems, but you can further ensure that Premiere 5 is running at top speed by using the Finder's Get Info command to allocate at least 30MB to 40MB of memory to Premiere. And that's real RAM—always turn off virtual memory before running the Mac version of Premiere. You can allocate more than 40MB if you like, but be sure that at least 3MB remain free for the Mac OS and QuickTime.

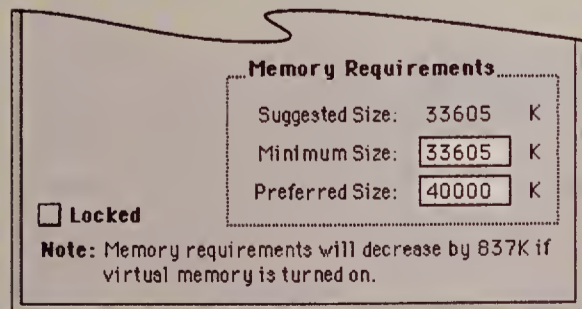

Premiere is happiest with virtual memory off and lots of real RAM allocated.

Timeline Tricks

THE TIMELINE WINDOW IS THE BEST PLACE TO GET A BIG-picture overview of a project and to apply filters, transitions, and other effects. Here are some timeline tips.

Fast Filter Copy and Paste

Say you've applied a few filters and special clip settings to one clip and you'd like to apply them to others. In the Timeline window, select the clip containing the effects and choose Copy. Then select the clip to which you want to apply the settings and choose

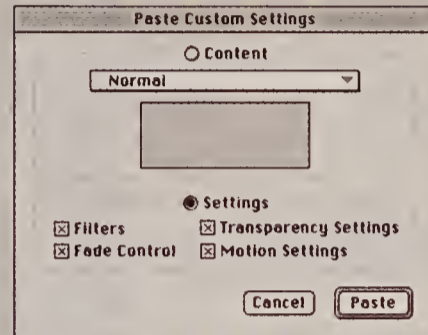

Paste Custom Settings Dialog Box

Paste Custom from the Edit menu. In the Paste Custom Settings dialog box (at left), click on the Settings button and then check or uncheck attributes as appropriate.

Quick Timeline Navigation

Use Premiere 5's Navigator palette to quickly move around within the Timeline window and to change the window's time scale. The edit line (A) is Premiere's equivalent of a blinking cursor in a word-processing program. To move the edit line, press shift and then drag

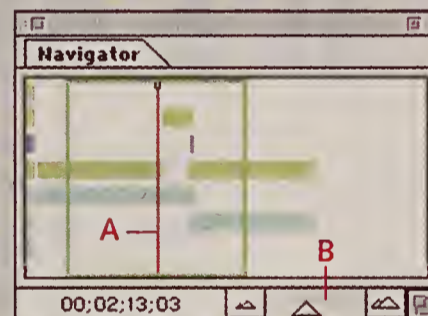

Navigator Palette

it. To change the time scale, use this slider (B). Drag it to the left to reduce the timeline and see a more bird's eye view, and drag it right to zoom in and view finer increments of time.

Toggling Snap to Edges

The Timeline window's snap-to-edges feature makes positioning clips easier by automatically snapping the clip you're dragging to the nearest clip, transition, or marker—much like the snap-to-guides feature that publishing programs provide. If you'd prefer to disengage the snap-to feature when moving a given clip, hold down the shift key while dragging the clip.

Faster Timeline Displays

For faster scrolling, configure the Timeline window to display only clips' file names rather than thumbnail frames, and turn off the display of audio waveforms. To do both, use the Timeline Window Options dialog box, which you can display by control-clicking within the Timeline window. In the Track Format section, click on the lowest radio button, next to Filename, and uncheck Show Audio Waveforms.

"Thank you for such a wonderful magazine. I only wish that it were daily because I'm always so anxious to get the next issue."

"I usually read it ahead of the stack of magazines I receive each month."

"I appreciate the broad range of topics and the fact that multiple platforms are covered."

"The articles really zero in on what 'I need to know.' I feel as though if I've read this magazine, I am 'informed.'"

"Good source of info I can't get elsewhere."

"It covers such a broad range of information in a field that requires consistent and frequent coverage."

"I have based several purchases on information from eMediaweekly in the past, and have been rarely disappointed."

"Like the up-to-date info on Mac and other PCs. Helps in decision making."

"I like the fact that you now go more in depth with the other platforms in use in the real world."

"It is the only pub that I now read for the graphics industry."

"It's excellent."

"Beautiful prepress and presswork. Smart editing, very informative and useful as a tool around here."

"My time is at a premium. I get the most current information without wading through the other five monthly pubs I receive."

"...it still seems to be the best overall view of the industries touched by graphic design."

"...It is by far the de facto source that often determines the direction our business changes."

"Only publication of its sort...great guys!"

The Reviews Are In!

We recently asked subscribers what they thought of eMediaweekly. In addition to their comments, nearly 90% of all respondents expressed satisfaction with eMediaweekly!

Of course we weren't that surprised by the comments, since eMediaweekly is expressly designed for the unique information needs of digital media managers involved in purchasing high-end content creation tools. Whether they're publishing on paper or in pixels, digital media managers need to keep

abreast of changing technology with the latest news and reviews. That's why they turn to eMediaweekly—the ONLY newsweekly covering the *entire* content creation market for print, Web and multimedia—*regardless of platform.*

FREE Subscription!

Subscribe today so you'll have ALL the answers you'll need tomorrow. Go to www.subscribe.emediaweekly.com to get your FREE subscription!

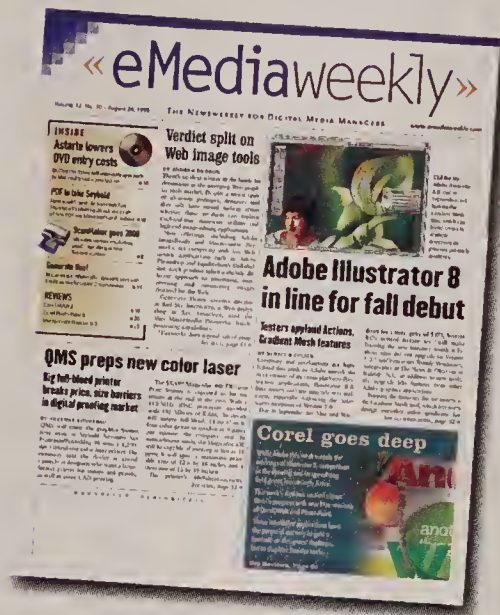

Published by Mac Publishing, L.L.C., a joint venture between Ziff-Davis Publishing Co. and IDG Corp.

« eMediaweekly »

THE NEWSWEEKLY FOR DIGITAL MEDIA MANAGERS

Say you saw it in Macworld. To purchase products advertised in this issue call the phone numbers below or log onto Macworld GetInfo at www.macworld.com/getinfo for FREE product information.

| Page No. | Advertiser | getinfo | Phone | Page No. | Advertiser | getinfo | Phone | Page No. | Advertiser | getinfo | Phone |
|----------|--------------------------------------|---------|---------------|----------|------------------------------|---------|--------------|----------|--------------------------------------|---------|--------------|
| 72 | 3Com | — | — | | | | | 34 | MicroMat | 67 | 800/829-6227 |
| 51 | Adaptec | — | — | 64 | Hire Knowledge | 207 | 800/937-3622 | 40,41 | Minolta Corporation | 104 | — |
| 10 | AEC Software | 203 | 800/450-1982 | 87 | Iiyama North America | — | 800/394-4335 | 53 | Mitsubishi Electronics America, Inc. | 261 | 800/843-2515 |
| 12 | Agio Designs | 265 | 800/688-2446 | 66 | Interland, Inc | 10 | 800/599-0547 | 19 | National Association of Photoshop | 94 | 800/738-8513 |
| 60 | ALSOFT | 140 | 800/257-6381 | 114 | Iomega | 103 | — | IBC | Newer Technology | 55 | 316/943-0222 |
| 49 | American Power Conversion | 72 | 888/289-APCC | 63 | ISO Productions | — | — | 13 | Orange Micro | 60 | 714/779-2772 |
| 8 | Anthro | — | 800/325-3841 | 11 | IXMICRO | 53 | 888/467-8282 | 55 | Palm Computing | — | — |
| IFC-3 | Apple Computer | — | — | 152 | J&R Computerworld | 282 | 800/221-8180 | 145 | ProDirect | 135 | 800/524-9952 |
| 150 | APS Technologies | 62 | 800/285-0638 | BC | Kensington | 1 | 800/535-4242 | 30,31 | Quark | 77 | 800/995-4343 |
| 184 | Aspyr Media | 90 | 888/212-7797 | 14,15 | La Cie | — | — | 58 | RealSoftware | 93 | 512/292-9988 |
| 47 | ATI Technologies, Inc. | 256 | — | 180 | Linux World | — | 800/657-1474 | 9 | RICOH | 4 | — |
| 148 | Bottom Line Distribution | 221 | 800/990-5693 | 128-135 | MacMall / Creative Computers | 131 | 800/222-2808 | 106 | Seybold | — | 888/800-8922 |
| 32,33 | Canon USA Video | 23 | 800/OK-Canon | 20-27 | MacConnection | 145 | 800/600-9417 | 110 | Seybold | — | 888/800-8922 |
| 144 | CDW Computer Centers, Inc. | 2 | 800/509-4239 | 57 | MacSoft | 30 | 800/229-2714 | 149 | The LLB Company | 220 | 800/848-8967 |
| 146, 147 | ClubMac | 96 | 800/CLUB MAC | 99 | MacSoft | 31 | 800/229-2714 | 136-143 | The Mac Zone | 71 | 800/436-0606 |
| 68,69 | Connectix | 105 | 800/950-5880 | 182 | MacSoft | 28 | 800/229-2714 | 65 | ViewSonic | 59 | 800/888-8583 |
| 94 | Dataviz | 151 | 800/270-0030 | 92,93 | MacWarehouse | 150 | 800/434-3035 | 39 | Vimage | 44 | 877/4VIMAGE |
| 28 | Diehl Graphsoft | 46 | 410/290-5114 | 121-127 | MacWarehouse | 150 | 800/434-3035 | 12 | VST Technologies, Inc. | 73 | 978/263-9700 |
| 16 | Epson America | 61 | 800/BUY-EPSON | 153 | Macworld Expo | — | 800/645-EXPO | 59 | Wacom Technology Corp. | 84 | 800/922-2585 |
| 67 | Fujitsu Computer Products of America | — | 800/626-4686 | 100-105 | Macworld EXpo | — | 800/645-EXPO | | | | |
| 6,7 | GCC Technologies | 43 | 800/422-7777 | 151 | MegaHaus | 229 | 800/786-1184 | | | | |
| 187 | Graphic Simulations | 91 | — | 82 | Metropolitan Life | 92 | — | | | | |

Macworld **Product Index**

A quick and easy product index from Macworld. Simply use this index to find the page or advertiser of the products which interest you. Then log onto GetInfo at www.macworld.com/getinfo to request more information. You can choose to have the information delivered to you by e-mail, postal mail or telephone.

| Page No. | Advertiser | getinfo | Page No. | Advertiser | getinfo | Page No. | Advertiser | getinfo | Page No. | Advertiser | getinfo |
|----------------------|------------------------|---------|----------------------------|--------------------------------------|---------|----------------------|------------------------------|---------|-------------------------------|-----------------------------------|---------|
| SOFTWARE | | | 13 | Orange Micro | 60 | MISCELLANEOUS | | | 20-27 | MacConnection | 145 |
| BUSINESS | | | 39 | Vimage | 44 | 49 | American Power Conversion | 72 | 92,93 | MacWarehouse | 150 |
| 10 | AEC Software | 203 | COMPUTER SYSTEMS | | | 55 | Palm Computing | — | 121-127 | MacWarehouse | 150 |
| CAD/CAM | | | 150 | APS Technologies | 62 | 9 | RICOH | 4 | 151 | MegaHaus | 229 |
| 28 | Diehl Graphsoft | 46 | 146, 147 | ClubMac | 96 | 59 | Wacom Technology Corp. | 84 | 145 | ProDirect | 135 |
| COMMUNICATION | | | DIGITAL CAMERAS | | | MODEMS | | | 149 | The LLB Company | 220 |
| 94 | Dataviz | 151 | 40,41 | Minolta Corporation | 104 | 72 | 3Com | — | 136-143 | The Mac Zone | 71 |
| ENTERTAINMENT | | | DISPLAY | | | POWERBOOK | | | ACCESSORIES | | |
| 184 | Aspyr Media | 90 | 32,33 | Canon USA Video | 23 | 12 | VST Technologies, Inc. | 73 | FURNITURE | | |
| 187 | Graphic Simulations | 91 | 87 | Iiyama North America | — | PRINTERS | | | 12 | Agio Designs | 265 |
| 57 | MacSoft | 30 | 53 | Mitsubishi Electronics America, Inc. | 261 | 16 | Epson America | 61 | 8 | Anthro | — |
| 99 | MacSoft | 31 | 65 | ViewSonic | 59 | 6,7 | GCC Technologies | 43 | SERVICES | | |
| 182 | MacSoft | 28 | ENTERTAINMENT | | | 9 | RICOH | 4 | MISCELLANEOUS | | |
| GRAPHICS/DTP | | | 13 | Orange Micro | 60 | SECURITY | | | 82 | Metropolitan Life | 92 |
| 30,31 | Quark | 77 | EXPANSIONS/UPGRADES | | | 49 | American Power Conversion | 72 | 19 | National Association of Photoshop | 94 |
| UTILITIES | | | 39 | Vimage | 44 | SYSTEMS | | | ON LINE | | |
| 60 | ALSOFT | 140 | HARD DISKS/STORAGE | | | IFC-3 | Apple Computer | — | 66 | Interland, Inc | 10 |
| 68,69 | Connectix | 105 | 148 | Bottom Line Distribution | 221 | MAIL ORDER | | | TRADESHOWS/CONFERENCES | | |
| 34 | MicroMat | 67 | 67 | Fujitsu Computer Products of America | — | 150 | APS Technologies | 62 | 180 | Linux World | — |
| 58 | RealSoftware | 93 | 114 | — | 103 | 148 | Bottom Line Distribution | 221 | 153 | Macworld Expo | — |
| HARDWARE | | | 14,15 | La Cie | — | 144 | CDW Computer Centers, Inc. | 2 | 100-105 | Macworld EXpo | — |
| BOARDS | | | 145 | ProDirect | 135 | 146, 147 | ClubMac | 96 | 106 | Seybold | — |
| 51 | Adaptec | — | INPUT DEVICES | | | 152 | J&R Computerworld | 282 | 110 | Seybold | — |
| 47 | ATI Technologies, Inc. | 256 | BC | Kensington | 1 | 128-135 | MacMall / Creative Computers | 131 | DIRECTORY | | |
| 11 | IXMICRO | 53 | | | | | | | | | |
| IBC | Newer Technology | 55 | | | | | | | | | |

MacWAREHOUSE®

Your #1 Source for Mac™ Systems and Products—since 1987!

SEE OUR 7 PAGES OF GREAT DEALS!

Get an iMac G3

for as low as

\$29.99!†
PER MONTH



PLUS...

FREE! 64MB RAM UPGRADE!
*\$29.95 installation fee applies. Limited time offer. Call today!

Instant memory upgrade to a total of: **96MB RAM** in iMac!

- Own an iMac computer for \$29.99† a month!
- No down payment! No payments due for 90 days!
- Instant approval within minutes! Call today to fill out a short application over the phone!

CPU1261: iMac G3 with **FREE 64MB MEMORY** \$1299.00
CPU1262: iMac G3 with **FREE 64MB MEMORY INSTALLED** \$1328.95

†67 monthly payments of \$29.74. 14.89% Annual Percentage Rate subject to increase or decrease. Payments deferred for the first 120 days subject to loan origination fee of \$54.13 and interest of \$35.44 charged on day 91. No prepayment penalty. Subject to approval of credit. Based on Estimated Retail Price of \$1299. Tax and shipping not included.



PowerPC G3!
Furiously Fast Processor

- 233MHz PowerPC G3 processor
- Built-in 15" monitor
- 4.0GB hard drive
- 32MB SDRAM (128MB max.)
- 24X CD • 56K modem
- 512K Backside Level 2 cache
- 2MB VRAM • 10/100Base-T Ethernet

MacWAREHOUSE CARRIES OVER...
30,000 PRODUCTS!

Order by phone, fax or through our website:

www.warehouse.com/md

24 hours a day,
7 days a week!



POWER MAC G3/300MHZ

- 300MHz PowerPC G3 processor • 64MB SDRAM (768MB max.)
- 6.0GB hard drive • 24X CD-ROM
- 100MB Iomega Zip drive
- 1MB backside level 2 cache
- 2MB SGRAM • 10Base-T Ethernet

Only **\$1999!**

Item # CPU1205

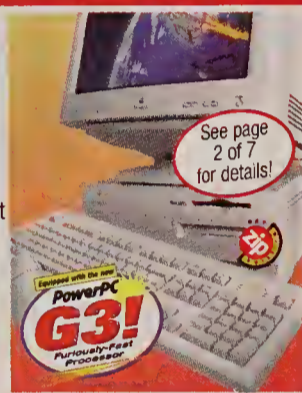

See page 2 of 7 for details!

APPLE IMAC G3s

Only **\$1199!***

Item # RCPU1260

- 233MHz PowerPC G3 processor
- 32MB RAM (128MB max.)
- 4.0GB hard drive • 24X CD-ROM drive
- 56K modem • 15" color monitor



See page 4 of 7 for details!

*Reconditioned system. Reconditioned computers may not include original application software. 90 days parts and labor warranty. All sales final. While supplies last.

Many other reconditioned Apple systems available. Call for details.

NEW VERSION! MAC OS 8.5

Only **\$89.95!***

SYS0292 after Internet shopping spree mail-in rebate

FREE Cyber Patrol, Solitaire Mania, Art Mania 10,000, Virex, & Compton's Interactive Encyclopedia when you purchase Mac OS 8.5! Ask for item # AAA0735.**

- New Sherlock "Find"—easily search the Web with multiple search engines and instantly get results!
- New PowerPC native AppleScript — runs five times faster than previous versions!

*Price after MacWAREHOUSE \$10 Internet shopping spree mail-in rebate. Price before rebate is \$99.95. Offer expires 1/15/99. Limit one rebate per customer (or total of 5 rebates per customer site). Rebate coupon and full details available at www.appleos85.warehouse.com or call customer service at 1-800-390-0706. **\$3.95 shipping & handling applies. Shipped in promotional packaging.

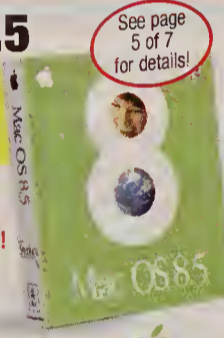

See page 5 of 7 for details!

POWERBOOK G3/233MHZ

- 233MHz PowerPC G3 processor
- 32MB SDRAM (192MB max.)
- 2.0GB hard drive
- 20X CD-ROM drive • 56K modem
- 12.1" active-matrix color display
- 10Base-T Ethernet

Only **\$2299!**

Item # CPU1249



See page 3 of 7 for details!

NEW! STYLUS 740 PRINTER

Only **\$279.95!**

Item # PR14065

- 1440 x 720 dpi
- USB compatible
- 6ppm black/5ppm color
- Smaller ink drops for amazing detail



See page 6 of 7 for details!

SONY DIGITAL CAMERAS

As low as **\$499.95!**

Price for Sony FD51 Digital Camera:

- High speed 2x disk drive

Item # IN7214

- Sony FD71 Digital Camera (shown):
 - 10X zoom lens • Whole disk copy
 - 2.5" color LCD w/Solar Window™ Panel
 - E-mail mode
- Only \$699.95; ask for item # IN7215.



See page 5 of 7 for details!

NEW VERSION! ADOBE ILLUSTRATOR 8.0

Upgrade only

\$119.95!

Item # UPG0887

FREE! Extensis COLLECT PRO 2.0 & Hot Door Transparency when you buy Adobe ILLUSTRATOR 8.0. Ask for Item # AAA0718.

*\$3.95 shipping and handling applies. Shipped in promotional packaging on one CD-ROM. Hurry! While supplies last!

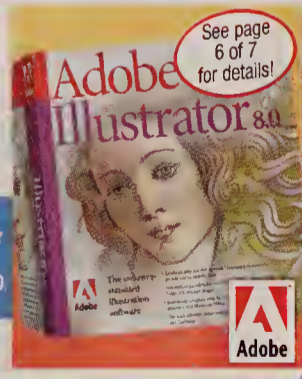

See page 6 of 7 for details!

1-800-434-3036 ★ www.warehouse.com/md

ORDER TOLL-FREE 24 HOURS A DAY, 7 DAYS A WEEK!

CANADA ORDERS CALL: 1-800-603-5139

MacWAREHOUSE
The largest direct computer reseller in the U.S.!

EXPRESS DELIVERY OVERNIGHT!
In-stock items, call by midnight (E).



Hi, I'm Michael. Call me for more great deals!

PAGE 1 OF 7



Authorized Catalog Reseller

MacWAREHOUSE

Screamin'-Fast Apple

Apple • Global Village • Iomega • Olympus • Microtek

Global Village 56K V.90 Modem

As low as **\$99.99*** when purchased at the same time as an Apple Power Mac G3 system! **AAPO491**

Save **\$40! ****

*Price without Power Mac G3 purchase is \$139.99. Ask for Item OMO3467. **Savings based on regular MacWAREHOUSE pricing as of this magazine printing.

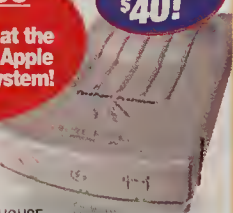

Iomega 100MB Zip Drive

Only **\$119.95!** **DR9279**



ZipPlus

works with both Parallel and SCSI Ports

Item # DRI2274 ONLY \$169.95

Iomega 100MB Zip Disks

As low as **\$9.99!** each, in 10-pack



Gray 100MB Zip Disk 10-pack Item # ME7756 ONLY \$99.95
Multi-color 100MB Zip Disk 10-pack Item # BN5265 ONLY \$99.95

Olympus D-600L Camera

Only **\$899.95!** **IN6660**



• 1280 x 1024 ppi resolution
• 3X zoom with TTL SLR viewfinder
• 4MB SmartMedia included
OLYMPUS
Accessories Kit: Includes leather camera case, 4MB SmartMedia Card, rechargeable batteries and recharger, AC adapter and software.
Item # AC23606 ONLY \$199.95!

16MB SmartMedia Cards

Only **\$99.95!** **MY10247**



• Digital film for digital cameras
• Compatible with most new digital cameras

PAGE 2 OF 7



APPLE 720 17" MONITOR Only **\$499!** Item # MON0602

Power Mac G3 266MHz Desktop

Only

\$1599!

ASK FOR ITEM # CPU1204.

- 266MHz PowerPC G3 Processor • 32MB SDRAM (768MB max.)
- 4.0GB HD • 24X Built-In CD-ROM • 512K backside level 2 Cache
- 2MB SGRAM • Built-in 10Base-T Ethernet

POWER MAC G3/266MHZ CPU1248: 64MB SDRAM, 4.0GB hard drive, DVD-ROM, 56K modem **\$1749**
While supplies last.

TOP OFF YOUR G3 WITH ONE OF THESE APPLE MONITORS:

- MON0658: ColorSync 750 17" **\$699**
- MON0657: ColorSync 850 20" .. **\$1499**

G3 SDRAM MEMORY UPGRADES:

- CHP0541: 32MB **\$99.95**
- CHP0542: 64MB **\$199.95**

POWER MAC G3/300MHZ DESKTOP

- 300MHz PowerPC G3 processor
- 64MB SDRAM (768MB max.)
- 6.0GB hard drive • 24X CD-ROM
- 100MB Iomega Zip drive
- 1MB backside level 2 cache
- 2MB SGRAM
- Built-in 10Base-T Ethernet

Only **\$1999!** Item # CPU1205



POWER MAC G3/300MHZ MINITOWER

- 300MHz PowerPC G3 processor
- 64MB SDRAM (768MB max.)
- 8.0GB hard drive • 24X CD-ROM
- 100MB Iomega Zip drive
- 1MB backside level 2 cache
- 6MB SGRAM
- Built-in 10Base-T Ethernet

Only **\$2399!** Item # CPU1233



POWER MAC G3/333MHZ MINITOWER

- 333MHz PowerPC G3 processor
- 128MB SDRAM (768MB max.)
- 9.0GB ultra-wide SCSI hard drive
- 24X CD-ROM drive • 6MB SGRAM
- 1MB backside level 2 cache
- Built-in 10Base-T Ethernet

Only **\$2999!** Item # CPU1234



APPLE MACINTOSH G3 SERVERS

- 300MHz G3 PowerPC processor
- 64MB SDRAM (768MB max.)
- 4.0GB ultra-wide SCSI HD • 24X CD
- Built-in 100Base-T Ethernet
- AppleShare IP 6.0 server software

As low as **\$2999!** Item # CPU1202

Macintosh Server G3/333MHz: 128MB RAM/Two 9.0GB ultra-wide SCSI HDs/24X CD/100 Base-T Ethernet/AppleShare IP 6.0 server software Item # CPU1203 only \$4599!



• Our sales staff is ready to take your order 24 hours a day, 7 days a week. We accept the following major credit cards: Visa, MasterCard, Discover Card/NOVUS, AmEx. Your credit card will not be charged until each item is shipped (no surcharge). CT, IL, NJ, OH, VA and WA residents add applicable sales tax.

• Overnight delivery just \$4.95 per order up to 3 pounds. For all orders over 3 pounds, shipping is \$4.95 plus an additional \$1.50 per pound or fraction thereof. (Example: shipping for a 4 pound order is \$6.45). Please add an additional handling charge of \$3.00 for all orders \$50.00 and under.

• Orders for "in-stock" items placed on weekdays up until 12:00 midnight (E), 10:00 pm (E) for Internet orders, ship same day for overnight delivery (barring system failure, etc.). We anticipate being able to ship "out-of-stock" items within 30 days.

• All items we sell come with the MacWAREHOUSE 30-Day Guarantee Against Defects. Call our Customer Service Department at 1-800-925-6227 for a Return Merchandise Authorization (RMA) number within 30 days of the original invoice date. All returns are subject to the following: 1. All products must be returned in original packaging. 2. Shipping and handling charges are not refundable. 3. Software and consumables are

not refundable unless returned unopened in original packaging with documentation. 4. Custom orders and cables are not refundable. 5. Products designated as "all sales final" are not refundable. If your Apple hardware is defective you must call Apple Computer, Inc. directly at 1-800-SDS-APPLE (1-800-767-2775). Apple Computer, Inc. will repair or replace products at its sole discretion. If you do return Apple hardware to MacWAREHOUSE, you will be assessed a 15% restocking fee which will be charged to your account.

Copyright© 1998 Micro Warehouse, Inc. MacWAREHOUSE® is a division of Micro Warehouse, Inc. Item availability and price subject to

change without notice. We regret that we cannot be responsible for typographical errors. All prices shown in U.S. dollars. Since we are not the manufacturer or publisher of any of the products we sell, Micro Warehouse makes no representations or warranties of any kind and assumes no liability concerning whether any of the products or services sold by us are Year 2000 Compliant. Year to our customers by the manufacturers or publishers of certain products.



We accept these major credit cards.



Power Mac G3s as low as \$1599!

Power Mac G3/266MHz desktop. See left page for details.

Apple • Global Village • Curtis • VST Technologies

Apple PowerBook G3

Only

\$2299!

- 233MHz PowerPC G3 processor
- 32MB SDRAM
- 2.0GB hard drive
- 20X CD-ROM drive
- 56K modem
- 512K backside level 2 cache
- 10Base-T Ethernet
- 12.1" Active-matrix color display

ASK FOR ITEM # CPU1249.

Floppy drive sold separately.
Ask for item # DRI2661.



Equipped with the new
PowerPC G3!
Furiously-Fast Processor

FREE† Curtis Carrying Case!

when you order an Apple PowerBook G3 today!
Ask for item # AAA0725. Offer good while supplies last.

†\$3.95 shipping and handling charge applies.

CURTIS

PowerBook G3 Accessories

NEW! VST Zip 100 Drive

Internal
as low as
\$219^{95!}
AAP0552



For PowerBook G3 Series

- Bootable (Mac OS 8 boot disk provided)
- *With the purchase of a six pack of Iomega Zip cartridges. Must appear on the same invoice.
- Iomega Zip cartridges; 6-PK, item # MED0394 ONLY \$79.95

56K V.90 Fax/modem PC Card

Only
\$189^{99!}
DMD3824



- K56 Flex and V.90 technology cuts Web page downloading time almost in half!



Microtek ScanMaker X6EL

As low as
\$249^{95!}
IN7420

MICROTEK



- 36-bit color images
- 600 x 1200 dpi optical resolution
- 8.5" x 14" legal size
- SCSI interface

Apple PowerBook G3 Floppy Drive

Only
\$109^{95!}
DRI2661



NEW! PowerBook G3 Battery

Only
\$219^{95!}
ACC3307

- Works with 1998 model G3 PowerBooks
- Lithium-Ion

PAGE 3 OF 7

APPLE POWERBOOK G3/233MHZ

- 233MHz PowerPC G3 processor
- 32MB SDRAM • 2.0GB hard drive
- 20X CD-ROM drive • 56K modem
- 10Base-T Ethernet
- 512K backside level 2 cache
- 14.1" active-matrix color display

Only
\$2799!

Item # CPU1238

Floppy drive sold separately.



APPLE POWERBOOK G3/266MHZ

- 266MHz PowerPC G3 processor
- 64MB SDRAM • 4.0GB hard drive
- 20X CD-ROM drive • 56K modem
- 10Base-T Ethernet
- 1MB backside level 2 cache
- 14.1" active-matrix color display

Only
\$3499!

Item # CPU1239

Floppy drive sold separately.



NEW! APPLE POWERBOOK G3/300MHZ

- 300MHz PowerPC G3 processor
- 64MB SDRAM • 8.0GB hard drive
- 20X CD-ROM drive • 56K modem
- 10Base-T Ethernet
- 1MB backside level 2 cache
- 14.1" active-matrix color display

Only
\$4499!

Item # CPU1259

Floppy drive sold separately.



APPLE POWERBOOK G3/300MHZ

- 300MHz PowerPC G3 processor
- 64MB SDRAM
- 8.0GB hard drive
- DVD-ROM drive • 56K modem
- 10Base-T Ethernet
- 1MB backside level 2 cache
- 14.1" active-matrix color display

Only
\$4999!

Item # CPU1240

Floppy drive sold separately.

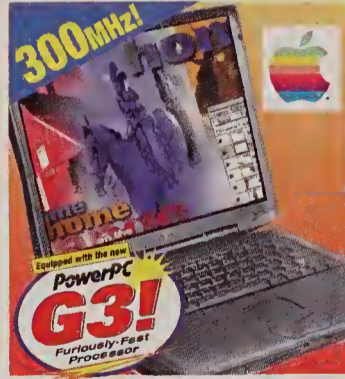

1-800-434-3036 ★ www.warehouse.com/md

ORDER TOLL-FREE 24 HOURS A DAY, 7 DAYS A WEEK!

CANADA ORDERS CALL: 1-800-603-5139

MacWAREHOUSE
The largest direct computer reseller in the U.S.!

EXPRESS DELIVERY OVERNIGHT!
In-stock items, call by midnight (E).



Hi, I'm Danielle. Call me for more great deals!



Authorized Catalog Reseller

MacWAREHOUSE

Powerful New Version

Apple • 3Com • Hitachi • Global Village • Sony • Macromedia

Macromedia Fireworks

Only **\$289^{95!}**
COM0996

FREE* PhotoDisc's 75 Backgrounds & Objects for the Web when you buy Fireworks! Ask for item # AAA0681.

*\$3.95 shipping and handling charge applies. While supplies last.



PowerBook Memory Upgrades

Call For Our Latest Low Prices!

- Installation available
- SDRAM

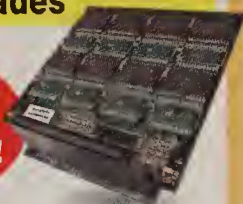

Palm III Organizer

Only **\$349!**
BN5506

- Includes MacPac translation software
- Flash upgradable memory
- Easy-to-read screen



8MB Flash Storage Cards

Only **\$49^{95!}**
MY7648

- 8MB compact flash
- Digital film for brand name digital cameras including:



Nikon Kodak Konica

Global Village 56K V.90 Modem



Only **\$139^{99!}**
DMD3467

- Compliant with both V.90 and K56Flex technology
- Flash ROM upgradable



PAGE 4 OF 7



Equipped with the new PowerPC G3! Furiously-Fast Processor

- 233MHz PowerPC G3 processor
- 32MB RAM (128MB max.)
- 4.0GB hard drive
- 24X CD-ROM drive
- 56K modem • 15" color monitor

(Free 64MB Memory Upgrade offer not valid with purchase of reconditioned iMacs)

*Reconditioned system. Reconditioned computers may not include original application software. 90 days parts and labor warranty. All sales final. While supplies last.

Many other reconditioned Power Mac G3 models available. Call for details.

Apple iMac G3

Only \$1199!*

Ask for item # RCP1260.

APPLE POWER MAC G3 DESKTOP
RCP10956: 233MHz PowerPC G3 processor • 32MB RAM (192MB max.) • 4.0GB hard drive • 24X CD-ROM • 10Base-T Ethernet
was \$1499 NOW ONLY **\$1249**

Monitors sold separately.

APPLE COLORSYNC 850 20" MONITOR
Only **\$1499!**
Item # MON0657

APPLE POWERBOOK DUO 230

- 33MHz 68030 processor • 12MB RAM
- 120MB HD • 14.4Kbps modem
- 9" grayscale Supertwist display
- ClarisWorks 3.0

Only **\$299!***
Item # RCP1188

RCP1195: PowerBook 180: 33MHz 68030 processor, 8MB RAM, 120MB HD, 14.4Kbps modem, 10" black & white active-matrix display, ClarisWorks 3.0:only \$499*

*Reconditioned system. Reconditioned computers may not include original application software. 90 days parts and labor warranty. All sales final. While supplies last.



APPLE POWERBOOK 520C

- 25MHz 68LC040 processor • 20MB RAM
- 240MB HD • 19.2Kbps modem
- 9.5" passive-matrix color display
- ClarisWorks 3.0

Only **\$699!***
Item # RCP1107

RCP1196: PowerBook 540c: 33MHz 68LC040 processor, 20MB RAM, 240MB HD, 19.2Kbps modem, 9.5" active-matrix color display, ClarisWorks 3.0:only \$799*

*Reconditioned system. Reconditioned computers may not include original application software. 90 days parts and labor warranty. All sales final. While supplies last.



HITACHI 17" MONITOR

HITACHI

- 17" monitor (15.9" viewable)
- Resolutions up to 1152 x 870 @ 75Hz
- 28mm dot pitch
- Manufacturer's 3-year warranty

Only **\$399^{95!}**
Item # MON0548



SONY 400PS 19" MONITOR

SONY

- 19" monitor (18" viewable)
- 25mm aperture grille
- 1600 x 1200 resolution @ 75Hz
- Short-neck design takes up less space
- Manufacturer's 3-year warranty

Only **\$869^{95!}**
Item # MON0630

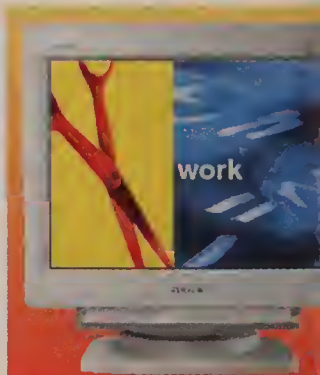

Jaz 2.0GB Cartridges

As low as **\$99^{95!}** each, in 5+ quantity
Ask for item # MED0508.

Quantity: 1-2 3-4 5+
Price: \$124.95 ea. \$109.95 ea. \$99.95 ea.



APC 200VA UPS

Only **\$89^{99!}**
Ask for item # DUP2098.

Full-time surge protection and instantaneous battery back-up to protect your equipment against brownouts, overvoltages, and blackouts.



Power Mac G3 Memory Upgrade

Only **\$99^{95!}** 32MB SDRAM
Ask for item # CHP0541.

- SDRAM DIMM
- Full selection available





Mac OS 8.5 only \$89^{95!} after rebate

See below for details.

Nikon • Epson • Iomega • Symantec • UMAX • Microsoft • Sony

New Version! Mac OS 8.5

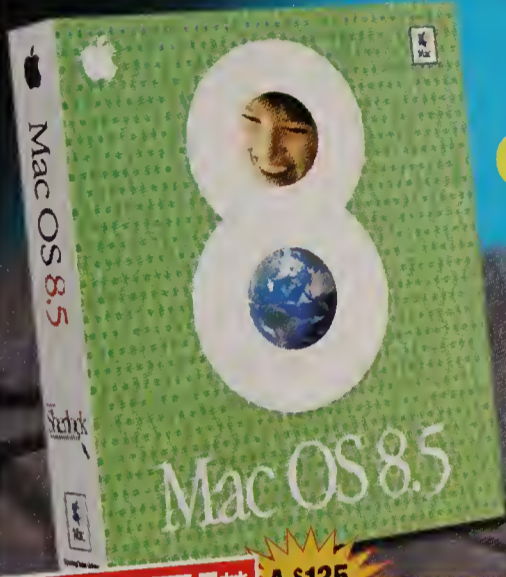

Only **\$89^{95!}*** after \$10 Internet shopping spree mail-in rebate



MAC OS 8.5 FEATURES:

- New PowerPC native AppleScript — runs five times faster than previous versions!
- New Sherlock "Find" — easily search the Web with multiple search engines and instantly get results!
- Improved Network Performance — integrated network browser makes navigating your network simple!
- New Smart Scrolling — makes navigating through your documents and Web sites more efficient than ever!

Ask for item # SYS0292.

FREE! A \$135 VALUE!

You get all these software titles

FREE** with your Mac OS 8.5 purchase!

- Cyber Patrol • Solitaire Mania • Art Mania 10,000
- Compton's Interactive Encyclopedia • Virex



Ask for item # AAA0735

**\$3.95 shipping and handling applies. Shipped in promotional packaging. †Value based on products sold separately as of this magazine printing.

*Price after MacWAREHOUSE \$10 Internet shopping spree mail-in rebate. Price before rebate is \$99.95. Offer expires 1/15/99. Limit one rebate per customer (or total of 5 rebates per customer site). Rebate coupon and full details available at appleos85.warehouse.com or call customer service at 1-800-300-0705.

NEW! NORTON UTILITIES 4.0

- HFS Plus compatibility
- Power PC native
- Enhanced SCSI/IDE support

Upgrade only

\$49^{95!}* after rebate

Item # UT11383



\$50 rebate!

After publisher's \$50 mail-in upgrade rebate. Price before rebate is \$99.95. Proof of ownership of previous version of Norton Utilities for Mac required. Limit one per customer. Rebate expires 30 days after purchase date. Copy of invoice required.

MICROSOFT OFFICE 98

Microsoft

- Includes: Word 98, PowerPoint 98, Excel 98 and Outlook Express

Upgrade only

\$259^{95!}

Item # UPG0778

BUS1150: Microsoft Office 98 Full Version only \$449.95



NIKON COOLPIX 900S DIGITAL CAMERA

Nikon



New!

- 1.3 mega pixel
- 2.0" color LCD display
- FREE! 8MB Compact Flash™ card and Duke Nukem 3D CD-ROM

Only **\$799^{95!}**

was \$899.95

Item # IN7439

Get a FREE* gift when you order online.

Every time you order from our full line of Mac products on the Web, you can get one of these FREE*: Marathon Infinity, Vertigo 3D Dizzy, Newpoint Surge SAFE Protector, and more!

*\$3.95 shipping and handling applies. Limit one per customer per order. Shipped in promotional packaging. While supplies last.



See our BLOWOUT SPECIALS and SUPER OFFERS — every day! Place your order online by 10:00 pm, (E) and get it the next day!

WAREHOUSE.COM

Epson Stylus Color 850 Printer

Only **\$349^{95!}** PR13559

EPSON

- 1440 x 720 dpi
- 9ppm black/ 5.5ppm color
- Optional Networking



Small ink droplets for amazing detail!

NEW! Sony Digital Cameras

As low as **\$499^{95!}** IN7214

- Sony FD51
- High speed 2x disk drive



Sony FD71 Digital Camera (shown). 1DX zoom lens • Whole disk copy • E-mail mode • 2.5" color LCD w/Solar Window™ Panel Only \$699.95, ask for item # IN7215.

DataDesk SmartBoard Keyboard

Only **\$99^{95!}** INP1466

- Designed to assist in the lessening of repetitive-stress injuries
- Helps you type with your hands, wrists, and forearms in a more natural position.

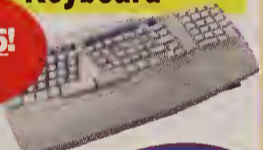

Easily fits in a standard-sized keyboard drawer!

1.0GB Jaz Cartridges

As low as **\$89^{95!}** each in 5+ quantity



Jaz 1.0GB 3.5" cartridges: Item # MED0177

| | | |
|----------------|----------------|---------------|
| 1-2 Cartridges | 3-4 Cartridges | 5+ Cartridges |
| \$99.95 ea. | \$94.95 ea. | \$89.95 ea. |

UMAX 1200S 30-bit Scanner

As low as **\$179^{95!}*** IN6249

UMAX

- 600 x 1200 dpi resolution
- 9600 x 9600 dpi enhanced
- Scans legal size 8.5" x 14"



*Price after mtr's \$50 mail-in rebate. Price before rebate is \$229.95. Ask for coupon # AA1131. Hurry, offer expires 12/31/98.

1-800-434-3036 ★ www.warehouse.com/md

ORDER TOLL-FREE 24 HOURS A DAY, 7 DAYS A WEEK!

CANADA ORDERS CALL: 1-800-603-5139

MacWAREHOUSE

The largest direct computer reseller in the U.S.!

EXPRESS DELIVERY OVERNIGHT!

In-stock items, call by midnight (E).



Hi, I'm Terri. Call me for more great deals!



Authorized Catalog Reseller

NEW VERSION!

MacWAREHOUSE

Upgrade to Adobe

Apple • Adobe • ATI • Epson • Kodak • Olympus

DC210 Plus Digital Camera

Only **\$499^{95!}**
IN7315

Kodak



was: \$699.95

- 2X zoom lens
- 1152 x 864 max. resolution
- 1.8" color LCD display

AC adapter and 8MB card now included!

DC210 Mac Connection Kit, only \$24.95! Item # ACC3243

Adobe Photoshop 5.0

Upgrade only **\$189^{95!}**
UPG0836



- Quickly undo or redo seven steps so you're free to experiment

Adobe Photoshop 5.0 upgrade for PC. Ask for item # UP4060.



Asante Fast 10/100 PCI Adapter

Only **\$49^{99!}**
DEC3343



- 10/100 PCI adapter (Mac/PC)
- Auto negotiation

10/100 PCI Adapter 5 pack (Mac/PC) only \$239.99! Ask for item # DEC3344.

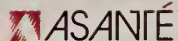

Extended On-Site Service



Six great reasons to get complete system coverage:

- 1 Toll-Free Technical Help available 24 hours a day!
- 2 Fast On-Site Support with next business day response in most areas for most items!
- 3 Free Replacement if unit cannot be repaired!
- 4 No Deductible — 100% coverage on parts and labor!
- 5 24- and 48-Month Coverage available from date of purchase!
- 6 Fully Insured — underwritten by A.M. Best!

Service you can depend on! Support and repairs are provided by DFS, which has been providing superior, price-competitive programs for over 20 years!

Consult the chart below to see which warranty best fits your needs:

| Cost of Computer and/or Peripherals | Warranty Price (48 months) | Ask for item # |
|-------------------------------------|----------------------------|----------------|
| \$701 - \$1,200 | \$99 | WAR0001 |
| \$1,201 - \$2,000 | \$149 | WAR0002 |
| \$2,001 - \$3,000 | \$189 | WAR0003 |

Call your Account Manager for details on orders over \$3,000.

Call your sales representative today!

*Note: This promotion is not a service agreement, but an outline of coverage available through DFS. Please call Micro Warehouse, Inc. for information and read the complete Service Agreement from DFS for exact coverages, terms, and conditions. On-site service begins after manufacturer's warranty expires. Plan not available on international or Florida orders. All Returns not covered under the standard MicroWAREHOUSE RETURN POLICY are subject to a \$25 Return Fee assessment.

PAGE 6 OF 7



NEW! Adobe Illustrator 8.0

Upgrade only **\$119^{95!}**

Ask for item # UPG0887.

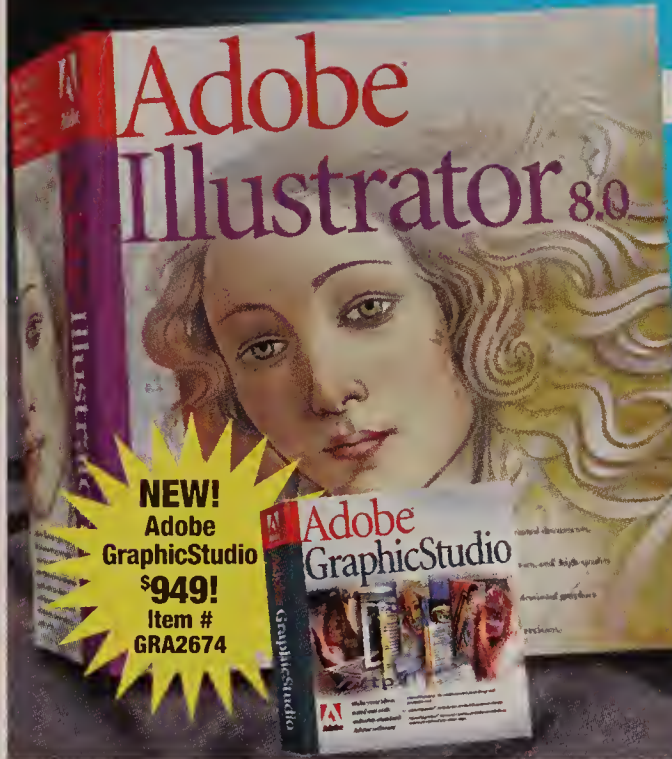

NEW! Adobe GraphicStudio **\$949!**
Item # GRA2674

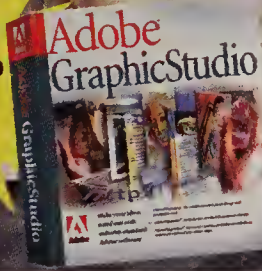

8 Great Reasons to Upgrade!

- 1 Art Brush: Save objects as Art brushes and apply to any path.
- 2 Photo Crosshatch Filter: Turn scanned photos into textured or crosshatched sketches.
- 3 New Pencil Tool: Tweak shapes easily and automatically.
- 4 Smooth and Erase Tools: Quickly smooth out crooked paths; smoothly erase parts of paths.
- 5 Actions Palette: Record and play back a series of steps to automate commonly illustrated tasks.
- 6 Smart Guides: Move, align, transform, and create shapes and paths with exactness.
- 7 Live Blends: Blends are now live so you can edit them freely.
- 8 Free Transform Tool: Consolidate scaling, skewing, rotating, and functionality in one tool.

Full version item # GRA2649, only \$359.95!

FREE! Extensis Collect Pro 2.0 & Hot Door Transparency

when you order Adobe Illustrator 8.0. Item # AAA0718. *\$3.95 shipping and handling applies. While supplies last. **Value based on individual products sold separately as of this magazine printing.

A \$149 VALUE!



EPSON STYLUS COLOR 740 PRINTER

EPSON

- 1440 x 720 dpi • USB compatible
- 6ppm black/5ppm color
- Smaller ink drops for amazing detail

Only **\$279^{95!}**

Item # PR14065

Stylus Color 850 (network) Ask for item # PR13559: \$349.95
Epson Black Ink Cartridge for Stylus Color 740 Ask for item # PA1581: \$29.99



FREE* F/A-18 HORNET 3.0



with purchase of 16X, 24X, or 32X CD-ROM Drive. Ask for item # AAA0520.

WHILE SUPPLIES LAST!

16X external CD-ROM drive only **\$129^{95!}**

Item # DRI2663

*\$3.95 shipping and handling applies. Shipped in promotional packaging on CD-ROM.



NEWER TECHNOLOGY G3 UPGRADE

newer technology!

- 220MHz G3 Processor
- 512K cache @ 110MHz

Only **\$479!**

Item # DRI2529

333MHz G3/1MB cache @ 166MHz Ask for item # DRI2864: \$1349
366MHz G3/1MB cache @ 183MHz Ask for item # DRI2868: \$1599
400MHz G3/1MB cache @ 200MHz Ask for item # DRI2869: \$2149



Up to 400MHz!

QUARKXPRESS 4.0

- Use style sheets for individual words, not just paragraphs!
- Zoom up to 800% magnification!
- Draw curved lines with Bézier tool and place text along curved lines!
- Eight different measurement systems to choose from!

Only **\$699^{95!}**

Item # DTP0557



\$10 Rebate!
New low price!

Fuji Zip Media

As **\$8^{99!}*** was \$9.99
low as **\$8** each, Mac Format.

Ask for item # ME7975

*Price after manufacturer's \$10 mail-in rebate for 10-pack. Price for 10-pack before rebate is \$99.99. Limit 2 per address. Also available in color # ME7977.

USR V.90 56K FaxModem

Only **\$147^{99!}**

Ask for item # DMD3448

*\$3.95 shipping and handling applies. Includes Earthlink Total Access, and Netscape Communicator. Shipped in promotional packaging. Ask for item # AAA0639.

FREE Modem Software with any US Robotics modem purchase.

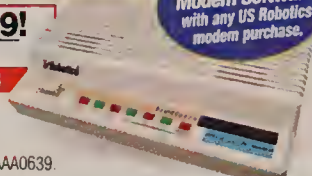

Amazon Inkjet Supplies

As **\$14^{99!}*** each, low as **\$14** in 2-pack

Ask for item # BN5560.

Color Ink Cartridge for Epson Stylus Color 850. Ask for item # BN5561, 2-pack only \$35.99. *\$3.95 shipping and handling applies. Shipped in promotional packaging. While supplies last.

FREE Amazon Inkjet Media with the purchase of 2 Inkjet cartridges.





Illustrator 8.0 for only \$119⁹⁵!

See left page for details.

Hewlett-Packard • Mitsubishi • Caere • Iomega • Asante • Farallon

HP LaserJet Printers

HP LASERJET 8000N
Only \$2629⁹⁵!

Ask for item # PR13724.

- Prints 24ppm • 1200dpi maximum resolution
- 133MHz RISC processor

NEW!



HP LaserJet 4000N
\$1449!

Item # PR12975

- Prints 17ppm
- 1200dpi maximum resolution
- 100MHz RISC processor
- Ethernet 10BaseT/10Base2 + LocalTalk

HP LASERJET 8000N BLACK TONER CARTRIDGE
As low as \$179⁹⁵ ea.
Item # 63223.
Call for details.



HP LASERJET 6MP
Only \$929⁹⁵!

Ask for item # INP0975.

- Prints 8ppm
- 600 x 600 dpi maximum resolution
- LocalTalk port • Adobe PostScript level 2

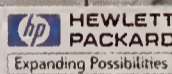
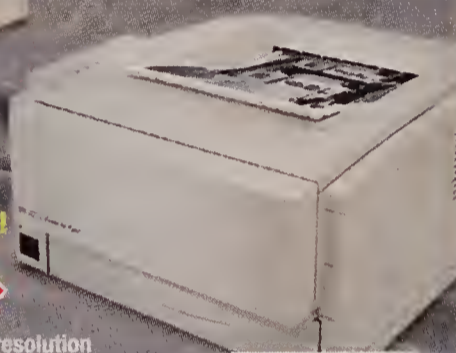

HP LASERJET 5000N (not shown)
• Prints 16ppm • 1200dpi • Prints 3 x 5 thru 11 x 17
Ask for item # PR13443. \$2049

NEW! HP LASERJET 8100N
• Prints 32ppm • 1200dpi
Ask for item # PR14315 \$2999⁹⁵

NEW! HP COLOR LASERJET 8500N
• Prints 24ppm/6ppm color • 600dpi
Ask for item # PR14213 \$6779

Marathon Infinity



FREE!
with every order!
AAA0593

• Blast your way through this alien nightmare!

*\$3.95 shipping and handling applies. While supplies last. Shipped in promotional packaging on CO-ROM.

EtherMac iPrint Adapter

Only \$109⁹⁹!
DEP1734

Farallon®

- Offers LocalTalk connectivity for your iMac
- Supports up to 8 LocalTalk-equipped printers or Macs



74 Minute CD-Recordables

As low as \$159!
each in 30+ quantities
ME7553



- New low price
- Branded single with Jewel Cases
- 650MB capacity

Kodak ds digital science™

NEW! Olympus D-400Z

Only \$799⁹⁵!
IN7514

- 1280 x 960 ppi resolution
- 3X optical lens
- Point and shoot ease-of-use



OLYMPUS

SupraExpress 56K Flex Speakerphone Modem

Only \$49⁹⁹!
after rebate
DMD2491

- Flash ROM upgradable
- *Price after mfr's \$50 mail-in rebate. Price before rebate is \$99.99. Offer expires 12/31/98. While supplies last.



PAGE 7 OF 7

MITSUBISHI 91TXM 21" MONITOR



21" (19.7" viewable)
Diamondtron CRT
.28 aperture grille
1600 x 1200 resolution @ 75Hz
Mfr's 3-year warranty

Only \$1089⁹⁵!

Item # MON0457

IOMEGA JAZZ 1.0GB CARTRIDGES



As low as \$89⁹⁵!
ea. in 5+ quantity

Item # MED0177

| Quantity | 1-2 | 3-4 | 5+ |
|------------|---------|---------|---------|
| Price/Disk | \$99.95 | \$94.95 | \$89.95 |



OMNIPAGE PRO 8.0



As low as \$79⁹⁵!

When purchased with any fax/modem or scanner from MacWAREHOUSE.

Item # AAP0518

OmniPage Pro 8.0 and fax/modem or scanner must appear on the same invoice. Shipped in promotional packaging. Retail packaging shown for promotional purposes only. While supplies last.



www.webauction.com

Power Macs starting at \$100!

Bids \$1 starting at

on Mac computers and lots of other great products.

New Auctions Daily!

Join the action at WEB Auction.com

Products shown not necessarily being auctioned currently.

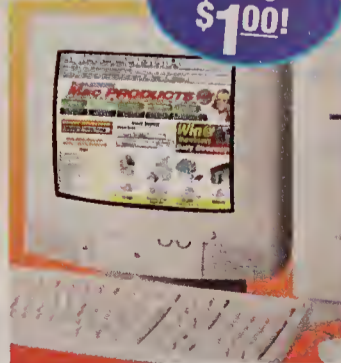

1-800-434-3036 ★ www.warehouse.com/md

ORDER TOLL-FREE 24 HOURS A DAY, 7 DAYS A WEEK!

CANADA ORDERS CALL: 1-800-603-5139

MacWAREHOUSE
The largest direct computer reseller in the U.S.!

EXPRESS DELIVERY OVERNIGHT!
In-stock items, call by midnight (E).



Hi, I'm Sue. Call me for more great deals!

NEW iMac™ — Now

The All-in-One Power-Packed Internet System for Your Home

You've heard it a million times... "computers are hard to use and the operating systems aren't user-friendly." Then, came the

Macintosh®. Now the company that started the PC revolution is helping parents, kids and students take advantage of Internet evolution.

Introducing the iMac, the totally translucent computer that combines all the possibilities of the Internet with the magic of the Macintosh!

The Most Original Mac Since the Original Mac!

Key Features:

- 233MHz PowerPC G3 processor
- 512K backside Level 2 cache
- 4GB IDE Hard Drive
- 66MHz system bus
- 32MB of RAM (exp. to 128MB)
- 24X CD-ROM drive
- Built-in 10/100BASE-T Ethernet
- Built-in 56K modem
- 15-inch (13.8-inch viewable) high quality display with 1024 x 768 resolution
- Incorporates a high-quality monitor with minimal flicker and crystal-clear image
- Two 12Mbps Universal Serial Bus (USB) ports which support USB devices such as printers, storage devices and hubs
- One 4Mbps Infrared (IrDA) port

Plus:

- 2MB SGRAM (exp. to 4MB)
- Built-in Stereo speakers w/SRS sound
- Includes 2D/3D graphics acceleration for outstanding multimedia capabilities
- Comes with a height-adjustable, space efficient keyboard
- Elegantly routes cables to avoid clutter and confusion

Also Includes:

- Mac OS 8.5, Microsoft Internet Explorer with Outlook Express 4.01, AppleWorks 5 (formerly ClarisWorks), Quicken Deluxe '98 from Intuit, FaxSTF from STF Technologies, MetaCreation's Kai's Photo Soap, MDK from InterPlay, Pangea Software's Nanosaur, Williams-Sonoma Guide to Good Cooking from Broderbund, and Earthlink's Total Access 2.01! Most software is pre-installed. Please call for details.



Additional Features:

- Like the original Mac, the iMac is totable. An integrated handle lets the 40-pound unit be easily moved and offers a place to thread a security cable.

- As with Apple's recent all-in-one education Macs, a handy rear door allows easy access to a slide-out chassis housing both the main logic board (and its RAM-and-processor daughtercard) and storage devices.

FREE With Any MAC Purchase



Return to Zork/BlackThorne

\$2.99 shipping & handling.
Shipped in promotional packaging.
Ask for #33452 While supplies last.

Compton's Interactive Encyclopedia '98

For the most comprehensive up-to-date information.

\$3.99 shipping & handling.
Ask for #36119 While supplies last



Flight Unlimited

by Looking Glass and A-10 Cuba

by PARSOFT
\$2.99 shipping & handling
Shipped in promotional packaging.
Ask for #38270

Surge Strip by Belkin

A must for every computer!
\$3.99 shipping & handling
Ask for #98675

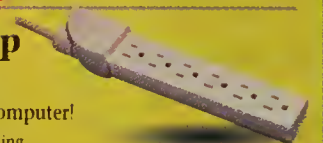

Order Any Time!
Open 24 Hours.

1-800-217-9492

Order Today by 10pm EST—Get it Tomorrow by 10:30am.

with Mac OS 8.5!



Apple® iMac™ only
\$1,299!
 or ALL for **\$29⁹⁵ Per Month**
See Apple Consumer Loan Disclosure below

Take Your Pick!
FREE Scanner & Extra 32MB
 w/ your iMac purchase. Ask for # 37333.
 \$30 installation fee applies.
 See scanner details above right.

or
FREE Extra 64MB RAM
 w/ your iMac purchase. Ask for # 34380.
 \$30 installation fee applies.
with YOUR iMac Purchase!

Apple Consumer Loan Disclosure
 Monthly payment of principal and interest based on a loan amount of \$1,372.38, consisting of manufacturers suggested retail price of \$1,299, a loan origination fee of \$54.13 and interest of \$19.25 accrued at 5.90% per annum during the introductory period of 90 days in which no loan payment is due. After the ninety day introductory period, the monthly variable interest rate ("Rate") equals the Prime Rate as published in The Wall Street Journal on the first business day of each month plus a spread. As of October 14th 1998, the Rate is 14.15%. 14.89% APR, subject to monthly increase or decrease. Monthly payments of \$29.74 are based upon the product purchase price of \$1,299, plus a one-time 4% loan origination fee imposed on the 91st day of the loan. Any change(s) to the Rate will take effect on the fifth business day of each month and will remain in effect until subsequently changed. 70-month term. No money down. No prepayment penalty. Loan rates and terms described herein available until November 5, 1998, thereafter call 1-800-730-4121 for current rates and terms. Each loan subject to credit approval.



HOT NEW USB PERIPHERALS FOR YOUR iMAC™!

SlimScan C3 USB for the iMac™
A \$79 Value FREE*
 w/ your iMac purchase

- > 36-bit color
- > 300 x 600dpi

*Free after mail-in and instant rebates. Rebates valid through 12/31/98. While supplies last.



Stylus Color 600 USB Printer

- > 1440 X 720dpi
- > 6ppm black
- > 4ppm color
- > Includes USB cable

MACMALL EXCLUSIVE! **EPSON \$99⁹⁹**
 w/iMac purchase! #36058
 Factory refurbished. 2 year warranty. While supplies last.

NEW! uConnect
 Immediately enables your Macintosh PDAs, printers, digital cameras, graphic tablets and other serial devices to use the iMac's new USB ports.
\$59⁹⁹ #34336
 with your iMac Purchase. Reg. Price is '84" (#34334).

SuperDisk 120MB Drive for the iMac™
 Reads & writes 120MB SuperDisk diskettes. Reads and writes standard HD 3.5" diskettes—in both Macintosh & PC formats!
\$149⁹⁹ #33844
 Includes One 120MB disk.

Imega® Zip® 100MB USB Drive
\$149⁹⁹ #34314
 New Translucent case!

See our Web site for more deals!
savebig.macmall.com

Mention your Priority Source Code: #ZMWD911

Mac Mall
 The Mall With It All...For Less!

FREE SHIPPING!

4 NEW MODELS

Features a high quality display—up to 14.1" diagonal.

Apple®
Macintosh®
PowerBook™ G3
Starting at

\$2,299!

#37388
Or Lease for \$92 per month

New!

Storage will never be an issue with up to 8GB hard drive space!

up to **300MHz**

The New G3 PowerBooks... Out-Perform Desktop Systems!

Stellar Features at an Affordable Price!

Processor and Memory

- 233, 266 or 300MHz PowerPC G3 processor—fastest performance ever in a notebook!
- 66MHz system bus speed
- Integrated floating point unit and 64K on-chip Level 1 cache (32K for data and 32K for instruction)
- 32 or 64MB RAM; 2 SO-DIMM slots support up to 192MB RAM

Storage

- 2, 4 or 8GB IDE hard drive
- 20X CD-ROM drive for use in expansion bay

Expansion & Networking Ports

- Two hot-swappable expansion bays
- ADB port, SCSI port, Serial port
- Built-in 10BASE-T Ethernet
- RJ-11 modem port, 4Mbps Infrared (IrDA) port
- PC Card Slots for two Type I, Type II or one Type III PC Card

Graphics, Video & Sound

- Features high-quality display, up to 14.1 inches (diagonal)
- 2MB or 4MB SGRAM video memory
- Up to 14.1 inch (diagonal) displays features built-in TFT XGA active matrix display, supporting millions of colors at 1024 x 768 pixel resolution
- 2D/3D graphics, through integrated

video controller

- S-video output for connecting to a TV
- 16-bit CD quality stereo input/output
- Two built-in stereo speakers

Portability

- Includes one Lithium-ion battery for up to 3.5 hours of normal use; supports two batteries for as much as 7 hours of use

Software

- Mac OS 8.1 which includes Internet access software, FAXStf, Now Contact & Up-to-Date, and WebWhacker

Order Any Time.
Open 24 Hours.

1-800-217-9492

Order Today by 10pm EST—Get it Tomorrow by 10:30am.

on ANY Mac Desktop, Mini-Tower or PowerBook!

Free UPS Ground shipping applies to actual desktop, Mini-Tower or PowerBook only and not to other items shipped on the same invoice. Sorry, iMac not included!



Why a G3?

Designed to be as attractive as it is functional!

Sleek ergonomics for more efficiency

Flip up keyboard gives easy access to RAM expansion slot & removable hard disk drive

New, more flexible configuration options!



4 NEW Models Available! Choose Your Ideal G3!

| Order | Speed | RAM | HD | CD-ROM | Modem | Display | Weight | Was | Now | Or Lease |
|----------------------|-------------------------|------|--------------------|--------|-------|---------------------|---------|-----|---------|----------|
| NEW #37388 | 233MHz | 32MB | 2GB | 20X | 56K | 12.1" Active matrix | 7.2lbs. | — | \$2,299 | \$92/mo |
| #37390 | 233MHz | 32MB | 2GB | 20X | 56K | 14.1" Active matrix | 7.8lbs. | — | \$2,799 | \$112/mo |
| #37391 | 266MHz | 64MB | 4GB | 20X | 56K | 14.1" Active matrix | 7.8lbs. | — | \$3,499 | \$140/mo |
| NEW #38076 | 300MHz | 64MB | 8GB | 20X | 56K | 14.1" Active matrix | 7.8lbs. | — | \$4,499 | \$180/mo |
| #37392 | 300MHz | 64MB | 8GB | DVD | 56K | 14.1" Active matrix | 7.8lbs. | — | \$4,999 | \$200/mo |
| #31414 | Apple Floppy disk drive | | \$99 ⁹⁹ | | | | | | | |

Add these Items to Your Order!

PowerBook G3 Accessories

Make your PowerBook G3 totally portable with these name-brand accessories!



| | | |
|--------|---|---------------------|
| #31413 | Apple AC Adapter | \$74 ⁹⁹ |
| #31414 | Apple Floppy disk drive | \$99 ⁹⁹ |
| #31873 | VST Charger for PowerBook G3 | \$149 ⁹⁹ |
| #31412 | Apple Lithium-ion battery | \$199 ⁹⁹ |
| #33200 | IX Micro Road Rocket 128-bit Video card for PB G3 | \$289 ⁹⁹ |
| #34062 | Apple DVD-Video Kit | \$499 ⁹⁹ |

Internal Zip® for Your PowerBook!

Faster than desktop Zip drives—no cables or batteries required!



| | | |
|--------|----------------------------|---------------------|
| #31872 | Zip Drive for PowerBook G3 | \$239 ⁹⁹ |
|--------|----------------------------|---------------------|

56K PC Card Modem

Comes with games and drivers for both Mac and PC on the FREE Get Connected CD.

FREE V.90 Upgrade!

BEST DATA



| | | |
|--------|---|---------------------|
| #31148 | 56K PC Card Modem for Mac | \$79 ⁹⁹ |
| #32248 | Megahertz 56K V.90 modem PC Card with XJack | \$224 ⁹⁹ |



DON'T FORGET MEMORY! Upgrade your G3

| | | |
|--------|---------------------------|---------------------|
| #31437 | 16MB PowerBook G3 Series | \$35 ⁹⁹ |
| #31438 | 32MB PowerBook G3 Series | \$85 ⁹⁹ |
| #31440 | 64MB PowerBook G3 Series | \$139 ⁹⁹ |
| #31442 | 128MB PowerBook G3 Series | \$295 ⁹⁹ |

Have your RAM professionally installed by one of our factory-trained technicians, for only \$30. Ask for #2214.

MacMall Exclusive

Purchase any Mac® and take your pick!

MacMall offers you the choice of any one of the 3 promotions

✓ **Up to 64MB RAM FREE!**
32MB FREE with any CPU in this catalog priced between \$1,299 - \$2,299

64MB FREE with any CPU in this catalog priced \$2,300 and above

\$30 Installation fee applies

✓ **MacMall's Exclusive Instant Cash Back!**

\$50 OFF All products in this catalog priced between \$1,299 - \$2,299

\$100 OFF All products in this catalog priced between \$2,300 - \$2,499

\$150 OFF All products in this catalog priced between \$2,500 - \$2,999

\$200 OFF All products in this catalog priced between \$3,000 - \$3,499

\$250 OFF All products in this catalog priced between \$3,500 - \$4,998

\$300 OFF All products in this catalog priced between \$4,999 and up

No coupons to mail in. No checks to wait for, just instant savings! Best of all, there is no limit—so order as many times you want...and keep saving.

Epson Stylus Color 600 Printer Blowout!

Up to \$90 in Savings!

\$99⁹⁹*



- Up to 1440 x 720dpi
- 6ppm black, 4ppm color
- Built-in Photo Printing

w/Mac purchase! #36133

w/iMac purchase! #36058

includes USB cable

*Price with CPU purchase. Regular price \$149.

Factory refurbished. 2 Year Warranty. While supplies last.

As Always... FREE Shipping!

We'll Beat Any Price on Any Computer!

We'll Beat ANY Advertised Price on any Computer in stock! We'll beat any price on any Mac® or PowerBook from any authorized Apple® catalog reseller, retail store, online store or apple.com!

"We'll beat any price" offer refers to any authorized Apple Catalog reseller, Retail store, Online Store or apple.com. Total rebates vary by machine and configuration. Call for complete details.

We do our best to be accurate but occasionally mistakes occur. We are not responsible for any typographical, photographic or technical errors. Products and packaging may differ from stock available at time of shipment; we reserve the right to substitute equivalent items.

See our Web site for more deals!
savebig.macmall.com

Mention your Priority Source Code: #ZMWD911

MacMall
The Mall With It All...For Less!

FREE SHIPPING!

Apple®
Power Mac™ G3
Desktops Starting at
\$1,599!

#37375
Or Lease for \$64 per month

up to **333MHz**

New!

Three standard 12" PCI slots
for easy expansion of system
functionality.

Monitor sold separately
on all models.

Next Generation Power Mac G3... for Performance & Expandability!

Innovative Features at an Affordable Price!

Processor and Memory

- 266, 300 or 333MHz PowerPC G3 processor
- 512K or 1MB Backside Level 2 Cache
- 133, 150 or 167MHz dedicated 64-bit backside bus
- 66MHz system bus
- Integrated floating point unit and 64K on-chip Level 1 Cache (32K data/32K instruction)
- 32, 64 or 128MB SDRAM (3 DIMM Slots support up to 768MB)
- 64-bit memory bus

Storage

- 4, 6, 8 or 9GB IDE or SCSI hard drive
- 24X CD-ROM drive (#37384 & #37387 come with a DVD-ROM Drive)
- 1.44MB Floppy Disk Drive
- Iomega Zip 100MB SCSI Drive (select models)

Expansion Options

- Three PCI expansion slots
- One or two 5.25" SCSI expansion bay

Networking Ports

- Two high-speed DMA serial ports
- Internal/External SCSI bus

■ ADB port

- Built-in 10BASE-T Ethernet connector; 10/100BASE-T Fast Ethernet card (select models)

Graphics, Video & Sound

- 2 or 6MB SGRAM (exp. to 6MB)
- Built-in 64-bit graphics and multimedia accelerator
- 128-bit 2D/3D graphics PCI card w/8MB EDO VRAM (select models)
- 16-bit stereo quality audio I/O

Software

- Mac OS 8.1

Order Any Time.
Open 24 Hours.

1-800-217-9492

Order Today by 10pm EST—Get it Tomorrow by 10:30am.

on ANY Mac Desktop, Mini-Tower or PowerBook!

Free UPS Ground shipping applies to actual desktop, Mini-Tower or PowerBook only and not to other items shipped on the same invoice. Sorry, iMac not included!



MacMall Exclusive

Purchase any Mac® and take your pick!

MacMall offers you the choice of any one of the 3 promotions

- ✓ **Up to 64MB RAM FREE!**
32MB FREE with any CPU in this catalog priced between \$1,299 - \$2,299
64MB FREE with any CPU in this catalog priced \$2,300 and above
\$30 Installation fee applies
- ✓ **MacMall's Exclusive Instant Cash Back!**

Why a G3?

Innovative System Architecture!

- New, more efficient logic board design
- Increased system bus speed to maximize processor performance
- New, more flexible configuration options!



Choose the G3 That's Right for You!

| | | | |
|--------|---|--------------|-------------------|
| #37375 | Power Mac Desktop/266MHz/32MB RAM/512K cache/4GB IDE Hard Drive 24X CD-ROM/10BASE-T Ethernet | only \$1,599 | Or lease \$64/mo |
| #37384 | Power Mac Desktop/266MHz/64MB RAM/4GB Hard Drive NEW DVD-ROM/56K Modem | only \$1,749 | Or lease \$70/mo |
| #37387 | Power Mac Desktop/300MHz/32MB RAM/4GB Hard Drive NEW DVD-ROM | only \$1,999 | Or lease \$80/mo |
| #37377 | Power Mac Desktop/300MHz/64MB RAM/1MB cache/6GB IDE Hard Drive 24X CD-ROM/Built-in Zip® Drive/10BASE-T Ethernet | only \$1,999 | Or lease \$80/mo |
| #37380 | Power Mac Mini-Tower/300MHz/64MB RAM/1MB cache/8GB IDE Hard Drive 24X CD-ROM/Built-in Zip® Drive/6MB VRAM/10BASE-T Ethernet/A/V in & out | only \$2,399 | Or lease \$96/mo |
| #37383 | Power Mac Mini-Tower/333MHz/128MB RAM/1MB cache 9GB Ultra-Wide SCSI Hard Drive/24X CD-ROM/6MB VRAM/10BASE-T Ethernet | only \$2,999 | Or lease \$120/mo |

Add these Items to Your Order!

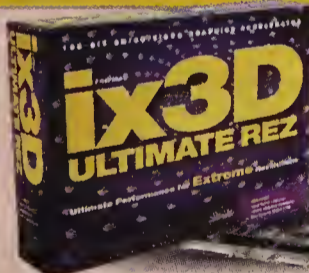

ix3D Ultimate Rez
128-bit 2D/3D/Video Graphics Accelerator
True 128-bit architecture for the ultimate in performance; 8MB EDO VRAM, 250MHz RAMDAC; supports resolution up to 1920 x 1200; Optimized PCI bus; over \$650 of FREE bundled software; including Ray Dream Studio 5 and Kai's Power Tools 3.
with any CPU, monitor or Adobe software order. Regular price \$499.99 #14733

only \$199⁹⁹
#35351

Apple MultipleScan 720 17" Color Display

16" viewable image;
.28mm dot pitch;
resolution up to 1280 X 1024 @ 60Hz;
cross-platform.



only \$499⁹⁹

#16467 MultipleScan 720 display \$499⁹⁹

- \$50 OFF** All products in this catalog priced between \$1,299 - \$2,299
 - \$100 OFF** All products in this catalog priced between \$2,300 - \$2,499
 - \$150 OFF** All products in this catalog priced between \$2,500 - \$2,999
 - \$200 OFF** All products in this catalog priced between \$3,000 - \$3,499
 - \$250 OFF** All products in this catalog priced between \$3,500 - \$4,998
 - \$300 OFF** All products in this catalog priced between \$4,999 and up
- No coupons to mail in. No checks to wait for. Just instant savings! Best of all, there is no limit—so order as many times you want...and keep saving.

Epson Stylus Color 600 Printer Blowout!

Up to \$90 in Savings!

\$99⁹⁹*

EPSON

- Up to 1440 x 720dpi
- 6ppm black, 4ppm color
- Built-in Photo Printing

w/Mac purchase! #36133

w/iMac purchase! #36058

includes USB cable

*Price with CPU purchase. Regular price \$149.

Factory refurbished. 2 Year Warranty. While supplies last.



As Always... FREE Shipping!
We'll Beat Any Price on Any Computer!

We'll Beat ANY Advertised Price on any Computer in stock!
We'll beat any price on any Mac® or PowerBook from any authorized Apple® catalog reseller, retail store, online store or apple.com!

"We'll beat any price" offer refers to any authorized Apple Catalog reseller, Retail store, Online Store or apple.com. Total rebates vary by machine and configuration. Call for complete details.

We do our best to be accurate but occasionally mistakes occur. We are not responsible for any typographical, photographic or technical errors. Products and packaging may differ from stock available at time of shipment; we reserve the right to substitute equivalent items.

See our Web site for more deals!
savebig.macmall.com

Mention your Priority Source Code: #ZMWD911

MacMall
The Mall With It All...For Less!

If You Don't See it,

Memory As low as \$175 per MB

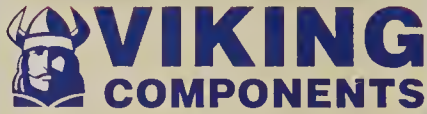

For Power Mac G3 Series

| | | |
|--------|-------------------|---------------------|
| #25730 | 16MB DIMM (10ns) | \$35 ⁹⁹ |
| #25747 | 32MB DIMM (10ns) | \$55 ⁹⁹ |
| #25750 | 64MB DIMM (10ns) | \$125 ⁹⁹ |
| #25821 | 128MB DIMM (10ns) | \$219 ⁹⁹ |

Why Choose Viking Memory?

24-7 Tech Support
Call 1-800-845-8777 24 hours a day, seven days a week for all Viking Memory Products

Lifetime Warranty
Memory backed for as long as you own your computer. If anything goes wrong, Viking will replace it.

**For Power Mac 7200-7600/
8500-8600/9500-9600 Series**

| | | |
|--------|------------------|---------------------|
| #72646 | 16MB DIMM (60ns) | \$35 ⁹⁹ |
| #72647 | 32MB DIMM (60ns) | \$59 ⁹⁹ |
| #72648 | 64MB DIMM (60ns) | \$115 ⁹⁹ |

For Power Mac G3 Series

| | | |
|--------|------------------|---------------------|
| #24574 | 16MB SDRAM DIMM | \$49 ⁹⁹ |
| #24578 | 32MB SDRAM DIMM | \$75 ⁹⁹ |
| #24579 | 64MB SDRAM DIMM | \$149 ⁹⁹ |
| #24582 | 128MB SDRAM DIMM | \$285 ⁹⁹ |
| #30270 | 256MB SDRAM DIMM | \$699 ⁹⁹ |

For Power Mac 4400 Series

| | | |
|--------|------------------|---------------------|
| #13936 | 16MB DIMM (60ns) | \$45 ⁹⁹ |
| #13937 | 32MB DIMM (60ns) | \$89 ⁹⁹ |
| #13938 | 64MB DIMM (60ns) | \$155 ⁹⁹ |

**For Power Mac 7200-7600/
8500-8600/9500-9600 Series**

| | | |
|--------|------------------|---------------------|
| #97312 | 16MB DIMM (60ns) | \$49 ⁹⁹ |
| #97217 | 32MB DIMM (60ns) | \$75 ⁹⁹ |
| #79314 | 64MB DIMM (60ns) | \$179 ⁹⁹ |

For Power Mac 6500 Series

| | | |
|--------|------------------|---------------------|
| #93961 | 16MB DIMM (60ns) | \$39 ⁹⁹ |
| #93963 | 32MB DIMM (60ns) | \$65 ⁹⁹ |
| #93964 | 64MB DIMM (60ns) | \$115 ⁹⁹ |

For Power Mac 4400 Series

| | | |
|--------|---------------|---------------------|
| #90678 | 16MB EDO DIMM | \$49 ⁹⁹ |
| #90679 | 32MB EDO DIMM | \$99 ⁹⁹ |
| #90680 | 64MB EDO DIMM | \$179 ⁹⁹ |

**For Macintosh PowerBook
G3 Series (non wallstreet)**

| | | |
|--------|-------------------|---------------------|
| #26311 | 32MB DIMM (60ns) | \$79 ⁹⁹ |
| #26312 | 48MB DIMM (60ns) | \$125 ⁹⁹ |
| #26313 | 64MB DIMM (60ns) | \$135 ⁹⁹ |
| #26314 | 96MB DIMM (60ns) | \$179 ⁹⁹ |
| #26315 | 128MB DIMM (60ns) | \$265 ⁹⁹ |

For Macintosh PowerBook G3

| | | |
|--------|---------------------|---------------------|
| #31437 | 16MB Module (10ns) | \$35 ⁹⁹ |
| #31438 | 32MB Module (10ns) | \$79 ⁹⁹ |
| #31440 | 64MB Module (10ns) | \$139 ⁹⁹ |
| #31442 | 128MB Module (10ns) | \$295 ⁹⁹ |

HP ScanJet 5p Scanner

24-bit w/36-bit image processor; 300 optical; 1200dpi integrated 8.5" X 11.7"; Includes Photoshop LE; Visioneer Paperport software.

only \$99⁹⁹ #89375

Special Offer!



While supplies last!

INCLUDED!

Princeton Ultra 17" Monitor!

15.8" viewable 1280 x 1024 Maximum resolution .28mm dot pitch.

\$199⁹⁹

#33080

With any computer purchase. Regular price \$229⁹⁹. Ask for #33057.

Factory refurbished. 90 Day Warranty. While supplies last!

Last Chance!



Smart One External 33.6 Modem

BEST DATA

\$29⁹⁹

#28937

FREE! Integrated data/fax software



Price reflects \$20 mfr. mail-in rebate. Offer valid through 11/30/98.

Mavica MVC-FD91 Floppy Disk Digital Camera

XGA 1024 X 768; 14X Optical zoom; 2.5" LCD; MPEG video recording Manual controls

only \$999⁹⁹ #37314



SONY

ix3D Ultimate Rez 128-bit 2D/3D/Video Graphics Accelerator

True 128-bit architecture for the Ultimate in performance; 8MB EDO VRAM, 250MHz RAMDAC; Supports resolution up to 1920 x 1200; Optimized PCI bus Over \$650 of FREE bundled software including Ray Dream Studio 5 and Kais Power Tools 3.

\$199⁹⁹ #35351

With any CPU, monitor or Adobe software order. Regular price \$499.99 #14733.

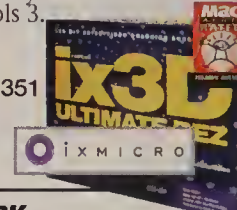

SupraExpress 56K External Fax/Modem

k56Flex, FREE v.90 upgrade via the Web. Includes a valuable CD full of communications software

\$69⁹⁹

#93568

Limited Time offer! While supplies last.



Sony CD Recordable Disc

650MB, 74 min.

as low as 49¢ ea.

#14452

After \$20 mail-in rebate when purchased in quantity of 10.

SONY



12X External CD-ROM Drive

100ms access rate; 128K cache; durable, cooled case.

\$89⁹⁹

#23968

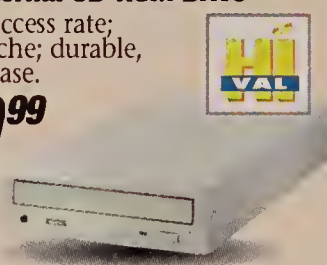

\$700 Price Drop—Stylus Color 3000 Printer

1440 X 720dpi; 7ppm black; 7ppm color; full-bleed 13" X 19"; PostScript ready

\$1,299⁹⁹

#37245



Stylus Color 800 Printer

1440 X 720dpi; 8ppm black; 7ppm color.

\$189⁹⁹

#33727

Factory Refurbished. 2 year warranty.



Fuji 10-Pack Zip 100MB Disks

as low as \$8⁹⁹ ea.

#88261

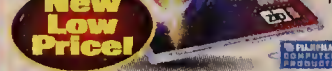

Price reflects \$20 mfr. mail-in rebate when purchased in quantity of 10.

Jaz 1GB External SCSI Drive

\$199⁹⁹ #15813

6.6MB/sec. transfer rate Includes 1GB Disk.

Factory Refurbished. 1 year warranty. Stock up on Jaz Cartridges: #74545

| | | |
|--------------------|--------------------|------|
| 1-2 | 3-5 | 6+ |
| \$99 ⁹⁹ | \$89 ⁹⁹ | Call |



Iomega ZipPlus 100MB External SCSI/Parallel Drive

only \$99⁹⁹

Includes 100MB Disk!

With purchase of 10-pack Zip Disks. Ask for #36876. Regular price \$109⁹⁹ (#36821). Factory refurbished. 1 year warranty.

PageWorks 20N Network Laser Printer

20ppm; 600dpi; Full-bleed 11" x 17"; Adobe PostScript L2; Ethernet card

\$1,299⁹⁹

#36145

Exclusive Offer!



Order Any Time.

Open 24 Hours.

Order Today by 10pm EST—Get it Tomorrow by 10:30am.

1-800-217-9492

Call Us!

Over 1,200 Products

Introducing the All New Mac Software Buyer's Guide!



Call For Yours Today!
1-888-425-MALL
Visit our Online catalog at software.macmall.com

Norton Utilities 4.0

The #1 selling utility for the Mac.
Upgrade for Only \$44⁹⁹
#34661
Price reflects \$50 mfr. mail-in upgrade rebate for previous users.

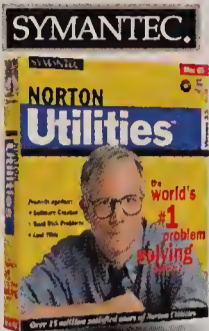

Norton AntiVirus 5.0 (formerly SAM 4.5)

Upgrade for Only \$24⁹⁹
#28475
Price reflects \$40 upgrade/crossgrade rebate. Price before rebate is \$64⁹⁹.

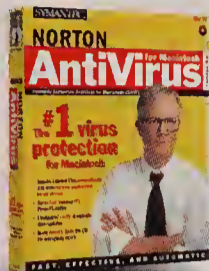

MacLink Plus Deluxe 10.0

With any NEW Power Mac G3 CPU purchase.
now \$57⁹⁹ only
#34158
Reg. Price is \$97.99



HOTTEST SOFTWARE DEALS!

Mac OS 8.5 Smarter. Faster. Far More Clever.



for Only \$88⁹⁹
#37231
Price reflects \$10 Instant MacMall Rebate

New!



Painter 5.5
New Web Edition!
Upgrade for as low as \$74⁹⁹
#35399

MetaCreations

Microsoft Office 98

Upgrade for Only

\$258⁹⁹

#26155
Ask your Account Manager about special offers with purchase.



Microsoft

EXTREME MAC 12-Pack by StarPlay

12 blockbuster games all together at one extremely low price.

for Only \$39⁹⁹
#33862



Retrospect Express

Easy and reliable backup; optimized for removable drives!
for Only \$44⁹⁹
#32924



QuarkXPress 4.0

The print & publishing standard!
for Only \$694⁹⁹
#23098



QUARK

Myth II Soulblighter

Greater realism and dazzling special effects!
for Only \$46⁹⁹
#32620



BUNGIE

Dreamweaver 2.0

The solution for Web site design and production



\$289⁹⁹
#37598

macromedia



Adobe Acrobat 3.0.1

Get the standard for document distribution electronically and on the Web.
Only \$184⁹⁹
#99375 CD Mac/Power Mac

Adobe Illustrator 8.0

One of the most innovative releases in Adobe's history. Upgrade Today! Includes FREE Photographic edges IV (a \$144.99 value—while supplies last)
Upgrade for Only \$119⁹⁹
#34983 Upgrade CD Power Mac



Adobe

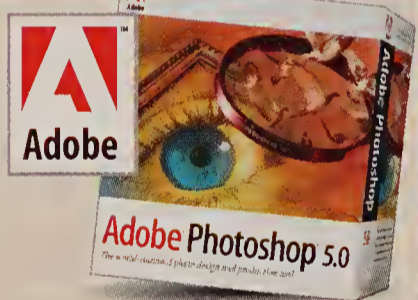

Adobe Photoshop 5.0

Includes new features like multiple undo, editable text, ColorSync support, Spot colors, new selection tools and more!
Upgrade for Only \$179⁹⁹
#30885 Upgrade CD Power Mac

Intuit

MacInTax Deluxe 99

#1 Best-selling, top-rated tax software
\$48⁹⁹
#38038



COREL

CorelDRAW 8

Competitive upgrade for Only \$99⁹⁹
#33817
Price reflects \$50 mfr. mail-in competitive upgrade rebate.
Offer valid through 1/31/99.



We do our best to be accurate but occasionally mistakes occur. We are not responsible for any typographical, photographic or technical errors. Products and packaging may differ from stock available at time of shipment; we reserve the right to substitute equivalent items.

See our Web site for more deals!
savebig.macmall.com

Mention your Priority Source Code: #ZMWD911

MacMall

The Mall With It All...For Less!

The Mac Zone[®]

Memory

FREE* 64MB RAM WITH EVERY

Own an iMac for Only \$29⁹⁸/mo.
Consumer Finance Program for the Apple iMac.

\$29⁹⁸/mo.
Call for details!

**Easy Finance Options Available/
Easy Payment Options!**
Call for pricing.

Take off with this deal!

FREE* 64MB

HURRY!
While supplies last

*After \$80 mail-in rebate. Low Zone price \$1379.00.

Order Item #07925

Only **\$1299**
#07728

SAVE \$100!

Microsoft Office 98/ iMac Bundle

#17682 iMac/MS Office 98 Gold Bundle . . . \$1699*

#17686 iMac/MS Office 98 Standard Bundle . \$1599*

*After \$100 mail-in rebate. Offer expires 12/31/98.



Not just for Internet!

Breakthrough Performance

- 233MHz PowerPC G3 processor/ 66MHz system bus
- 4.0GB IDE hard drive
- 32MB SDRAM, expands to 128MB
- 512K of backside level 2 cache

Advanced Multimedia

- 15-inch monitor (13.8-inch viewable) /1024x768 max. res 75MHz refresh / 28mm dot pitch
- 24X CD-ROM
- 2MB SGRAM, expandable to 6MB
- Built-in stereo speakers w/ simulated surround sound (SRS)
- Integrated microphone
- Two headphone jacks

Integrated Communications

- Built-in 56K modem
- 10/100Base-T Ethernet
- Two 12Mbps Universal Serial Bus (USB) ports
- 4Mbps infrared technology (IrDA) port

iMac Rocks!

In terms of the Internet, the iMac has it all.

— Adam Engst, MacWEEK

Included G3 Software

Pre-Installed

- Apple Works
- MS Internet Explorer
- Netscape Navigator
- Earthlink Total/Access
- FAXstf
- Nanosaur
- Quicken Deluxe 98*
- Williams-Sonoma Guide to Good Cooking*

*Requires CD (comes w/unit)

Also Included

- Kai's Photo Soap SE
- MDK



Products shipped in promotional packaging.

G3 Advantages

Consumer Performance Comparison



◀ Apple optimized this new PowerPC processor specifically for Mac OS 8's multitasking capabilities. Its innovative backside cache technology dramatically increases the processor's performance.

we're open 24/7
hours a day
days a week

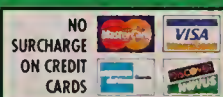

Corporate bids welcome! Fax to 1-800-684-8080

1-800-436-0606 WWW.ZONES.COM

Source Code **MW9901**

A NASDAQ COMPANY Ticker Symbol MZOL

Madness!

NEW iMac COMPUTER SYSTEM!

Get Connected with USB Products for your new iMac!

STORAGE

Imation USB Superdisk
ONLY \$148⁹⁸
 #12196



Imega USB Zip Drive
ONLY \$149⁹⁸
 #95251



SyQuest USB SparQ Drive
ONLY \$249⁹⁸
 #37174



| | | |
|------|-----------------------------------|----------|
| 2196 | Imation 120mb SuperDisk USB drive | \$148.98 |
| 5295 | LaCie 4.3GB USB hard drive | \$299.98 |
| 7174 | Syquest SparQ 1GB USB drive | \$249.98 |
| 5251 | Imega Zip Drive | \$149.95 |

PRINTERS

HP 672c w/ USB
ONLY \$219⁹⁸
 #60203



Epson Stylus 740
ONLY \$249⁹⁸
 #31720



| | | |
|-------|---|----------|
| 60203 | HP DeskJet 672c w/USB cable kit | \$219.98 |
| 31720 | Epson Stylus 740 USB color printer | \$249.98 |
| 60255 | HP DeskJet 694c (black) w/USB cable kit | \$264.98 |
| 60288 | HP DeskJet 697c printer w/USB cable kit | \$245.98 |

CONNECTIVITY

AsanteTalk 10T to LocalTalk Cable
ONLY \$99⁹⁸
 #16630



Entrega 4-port USB hub
ONLY \$79⁹⁸
 #77949



| | | |
|-------|--|---------|
| 37060 | KeySpan USB -Serial adapter | \$78.98 |
| 31911 | Macally iHub USB 4-port hub | \$49.98 |
| 44343 | Momentum Uconnect USB-Serial printer adapter | \$67.98 |
| 98317 | Momentum Uconnect USB-Serial adapter | \$67.98 |
| 13177 | USB 3-ft cable | \$6.98 |
| 13180 | USB 6-ft cable | \$7.98 |
| 13182 | USB 8-ft cable | \$8.98 |

SCANNERS

UMAX 1220U Duo Deluxe
ONLY \$149⁹⁸
 #18386



| | | |
|-------|-------------------------------|----------|
| 18386 | Umax Astra 1220U Duo DLX | \$149.98 |
| 96856 | Microtek SlimScan USB scanner | \$79.98 |
| 18479 | AGFA 1212u USB scanner | \$119.98 |

Accessories

Macally iBall USB Trackball
ONLY \$39⁹⁸
 #31906



| | | |
|-------|------------------------------------|---------|
| 31906 | Macally iBall 2-button USB mouse | \$39.98 |
| 31933 | Macally iKey USB extended keyboard | \$39.98 |
| 31901 | Macally iMouse USB mouse | \$24.98 |

Digital Cameras

| | | |
|-------|------------------------------------|----------|
| 55440 | QuickCam VC USB | \$99.98 |
| 73282 | Kodak DC220 digital camera | \$699.98 |
| 73283 | Kodak USB DC220/260 digital camera | \$999.98 |

OS 8.5 is Here!

ONLY \$79⁹⁸
 #72617 **New!**
Get Mac OS 8.5 for ONLY \$79⁹⁸
 with your \$100 (or more) Mac Zone purchase! **\$89⁹⁸**
 Otherwise, get it for our Low Zone Price of **\$89⁹⁸**



FREE!

GoLive CyberStudio 2.0 Personal Edition
 with your iMac purchase!
 While supplies last. Ask for Item#71965



iMac Top 12 List

| | | |
|-----|---|---------------------|
| 1. | Microsoft Office 98 #55871 | \$449 ⁹⁸ |
| 2. | Act 2.8 #06231 | \$149 ⁹⁸ |
| 3. | Norton AntiVirus 5.0 #00116 | \$63 ⁹⁸ |
| 4. | TechTool Pro 2.0 #87067 | \$94 ⁹⁸ |
| 5. | Norton Utilities 4.0 #04890 | \$96 ⁹⁸ |
| 6. | Virtual PC 2.1 98 #20634 | \$168 ⁹⁸ |
| 7. | StuffIt Deluxe 5.0 #41596 | \$74 ⁹⁸ |
| 8. | Connectix Triple Pack: Includes RAM Doubler 8, Speed Doubler 8, Surf Express #32550 | \$84 ⁹⁸ |
| 9. | Family Tree Maker Deluxe #80635 | \$79 ⁹⁸ |
| 10. | Extreme Mac 12 Pack #07427 | \$39 ⁹⁸ |
| 11. | Myth 2: SoulBligher #34779 | \$49 ⁹⁸ |
| 12. | Carmaggedon #72741 | \$29 ⁹⁸ |

Call for your FREE CATALOG!

All the latest computer products at discount prices!



Expect the Best!

Low Prices • Selection • Expertise

If for any reason you are not satisfied, please call our No Excuses Hotline: 1-800-258-0270.

1-800-436-0606

www.zones.com

Credit cards are not charged until the order is shipped. Most products ship the same day (barring system failure, etc.). Shipping options include Ground, 2nd Day and Overnight delivery. Freight is based on average product weight. Handling extra. Insurance available. Special orders may require special shipping and handling charges. Call for international shipping rates. Prices and product availability subject to change without notice. Specials and promotions may be limited to stock on hand. Not responsible for typographical errors.

©1999 Copyright Multiple Zones International Inc. All rights reserved. Unauthorized duplication is a violation of applicable laws. Apple, the Apple logo, Macintosh and PowerBook are registered trademarks of the Apple Computer, Inc.

The Mac Zone

Power Up

FREE* 64MB RAM WITH EVERY



BITE
into this deal!

FREE* 64MB

OS 8.5 is Here!

ONLY \$79⁹⁸
#72617

New!

Get Mac OS 8.5
for ONLY **\$79⁹⁸**

with your \$100 (or more) Mac Zone purchase! **\$89⁹⁸**
Otherwise, get it for our Low Zone Price of **\$79⁹⁸**

HURRY!
While supplies last

Order Item
#07971

*FREE after Mfr Mail-in rebate. Memory price will be added to the cost of the G3 you select.

Powered by the
High Speed
PowerPC™
G3
processor!

| Memory Upgrades G3 PowerBook® Series | | |
|---|--------|----------|
| UPGRADE | ITEM # | ONLY |
| 32MB Upgrade | #05057 | \$86.98 |
| 64MB Upgrade | #05059 | \$186.98 |
| 128MB Upgrade | #05061 | \$364.98 |

*Apple Business Lease: 36-month, fair-market value lease based on approved credit (\$1250 minimum lease amount). Other leasing options available. Call 1-800-611-9751 for details. Apple Commercial Credit is administered by Dana Commercial Credit Corporation. PowerPC™ and the PowerPC logo™ are the trademarks of International Business Machines Corporation, used under license therefrom. **Extended service provided by a third party provider. Call for full details.

Check out The Mac Zone's best selling products!

| Digital Cameras | |
|-----------------|---|
| 73283 | Kodak DC260 Digital Camera \$899.98 |
| 20250 | Sony FD71 Mavica Digital 10x Zoom Digital Camera w/ FREE 10pk of Floppy Diskettes \$699.98 |
| 93849 | Sony FD81 Mavica Digital 3x Optical Zoom Digital Camera w/ FREE 10pk of Floppy Diskettes \$799.98 |
| 90636 | Nikon Coolpix 900S Digital Camera \$749.98 |
| 53947 | Olympus D-600L Digital Camera \$899.98 |
| 32256 | Olympus D-500L Digital Camera w/ FREE SNAPZ SmartMedia 2MB Memory \$699.98 |
| 32260 | Olympus D-320L Digital Camera w/ FREE SNAPZ SmartMedia 2MB Memory \$399.98 |
| 32258 | Olympus D-340L Digital Camera w/ FREE SNAPZ SmartMedia 2MB Memory \$499.98 |
| 32308 | Epson PhotoPC 700 Digital Camera w/ FREE SNAPZ ATA 4MB Compact Flash Memory \$599.98 |
| 32261 | Olympus D-220L Digital Camera w/ FREE SNAPZ SmartMedia 2MB Memory \$299.98 |
| 73282 | Kodak DC220 Digital 2x Zoom Camera \$699.98 |

| Fixed HD / CD Drives | |
|----------------------|---|
| 43116 | Duquant Fireball ST 3.2GB SCSI 5400 Int hard drive DEM \$199.98 |
| 70441 | La Cie 4.3GB Internal SCSI 5400RPM \$279.98 |
| 70446 | La Cie 4.3GB External SCSI 5400RPM \$369.98 |
| 70443 | La Cie 6.4GB Internal SCSI 5400RPM \$409.98 |
| 70448 | La Cie 6.4GB External SCSI 5400RPM \$479.98 |
| 12135 | La Cie 8.4GB Internal SCSI 5400RPM \$529.98 |
| 12155 | La Cie 8.4GB External SCSI 5400RPM \$599.98 |
| 70444 | La Cie 9.1GB Internal SCSI 5400RPM \$539.98 |
| 70449 | La Cie 9.1GB External SCSI 5400RPM \$649.98 |
| 38221 | La Cie DVD-RAM External SCSI Drive \$799.98 |
| 70409 | La Cie 4x8 External SCSI CD-Recorder \$429.98 |
| 60513 | La Cie 4x6x2 External SCSI CDRW w/Toast \$529.98 |
| 95249 | La Cie 36x SCSI External CD-Rom Drive \$159.98 |
| 37174 | SparD 1GB Ext USB Drive \$249.98 |
| 91952 | Fuji CD-R 74min Single \$1.98 |
| 47562 | Fuji CD-R 5 pack with \$10 rebate \$14.98 |
| 59776 | Fuji CD-R 10 pack with \$20 rebate \$29.98 |
| 21258 | Fuji CD-R 25 pack with jewel cases \$38.98 |

| Zip Drives and Media | |
|----------------------|--|
| 51752 | Zip Internal ATAPI w/5.25 mounting \$99.95 |
| 73832 | Zip Internal SCSI w/5.25 mounting \$119.95 |
| 55181 | Zip External SCSI Reconditioned \$99.95 |
| 12220 | Zip External SCSI \$119.95 |
| 52581 | ZipPlus External SCSI & Parallel \$169.95 |
| 32251 | Zip large carrying case \$29.95 |
| 83475 | Zip PowerBook SCSI adapter \$19.95 |
| 12236 | Iomega Zip 100MB Mac Media Gray 3pk \$49.95 |
| 12237 | Iomega Zip 100MB Mac Media Gray 6pk \$79.95 |
| 12238 | Iomega Zip 100MB Mac Media Gray 10pk \$99.95 |
| 73831 | Iomega Zip 100MB Mac Media Color 10pk \$99.95 |
| 88195 | Fuji Zip Color 5pk with \$10 rebate \$59.98 |
| 37185 | Fuji Zip Color 10pk with \$10 rebate \$99.98 |
| 88194 | Fuji Zip Gray 5pk with \$10 rebate and Free Case \$59.98 |
| 37186 | Fuji Zip Gray 10pk with \$10 Rebate \$99.98 |
| 37041 | Fuji Zip Gray 20pk w/ 3 Free Disks by mail \$198.98 |
| 86334 | Fuji Zip Media 100MB Mac Disk \$14.98 |

| Removable HD and Media | |
|------------------------|--|
| 73771 | Jaz 1GB SCSI Int Drive Reconditioned \$189.98 |
| 73839 | Jaz 1GB SCSI Ext Drive Reconditioned \$199.98 |
| 95233 | Jaz 2GB SCSI Int Drive \$349.98 |
| 95234 | Jaz 2GB SCSI Ext Drive \$349.98 |
| 73838 | SyJet 1.5GB Ext SCSI Removable hard drive \$299.98 |
| 37174 | SparQ 1GB Ext USB Drive \$249.98 |
| 82841 | Jaz large carrying case \$29.95 |
| 43360 | Jaz Card PCMCIA Fax SCSI 2 \$124.98 |
| 81235 | Jaz 1GB Cartridge \$99.98 |
| 75663 | Jaz 1GB Cartridge 3-Pack \$269.98 |
| 73835 | Jaz 2GB Cartridge \$124.98 |
| 73836 | Jaz 2GB Cartridge 3-Pack \$299.98 |
| 83366 | SyJet Mac Cartridge 3-Pack \$199.98 |
| 83365 | SyJet Mac Cartridge Single \$79.98 |
| 14900 | SyJet Portable Drive Case \$39.98 |

we're open
24 7
hours a day
days a week



Corporate bids welcome! Fax to 1-800-684-8080

1-800-436-0606 **www.zones.com**

Source Code
MW9901

A NASDAQ COMPANY Ticker Symbol MZO

Your PowerBook!

NEW APPLE® MACINTOSH® G3 POWERBOOK

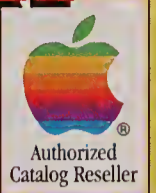

MAC ZONE EXCLUSIVE!



\$288
Software
Value!

GoLive
CyberStudio

SAVE BIG!

on SoftWindows 95 5.0
Purchase a PowerBook G3
and get SoftWindows 95 5.0 for **Only \$124.98**

PLUS

GET GoLive CyberStudio
Personal Ed. **FREE!**

Ask for Item #17294.

Offer is good while supplies last. (Software offered is full retail packaging)

NOW
\$2299
#07943

OR LEASE
FOR JUST
\$81/Mo.*

Outstanding performance
at an unbeatable price

Apple® PowerBook®
G3/233MHz

**Active
Matrix!**

233
MHz

32MB
RAM

2.0GB
Hard Drive

20x
CD-ROM

56K
MODEM

10
Base-T
Ethernet

ONLY
\$2799
#19056

OR LEASE
FOR JUST
\$99/Mo.*

56K modem lets you tap into
your network or the Internet

Apple® PowerBook®
G3/233MHz

233
MHz

32MB
RAM

8.0GB
Hard Drive

20x
CD-ROM

14.1"
TFT DISPLAY

10
Base-T
Ethernet

56K
MODEM

ONLY
\$3499
#19057

OR LEASE
FOR JUST
\$123/Mo.*

Showcase your multimedia
creations wherever you go

Apple® PowerBook®
G3/266MHz

266
MHz

64MB
RAM

4.0GB
Hard Drive

20x
CD-ROM

14.1"
TFT DISPLAY

10
Base-T
Ethernet

56K
MODEM

Accessories for your G3 PowerBook!

- #05682 PowerBook G3 Floppy Disk Drive \$104.98
- #05683 PowerBook G3 AC Power Adapter \$79.98
- #07703 PowerBook G3 Li-ion Battery \$199.98

SEE LAST PAGE OF THIS AD
for more great PowerBook solutions.

The **ONLY**
PowerBook with DVD

Apple® PowerBook®
G3/300MHz

OR LEASE
FOR JUST
\$176/Mo.*

ONLY
\$4999
#19058

With DVD!

ONLY
\$4499
#07968

With CD-ROM!

OR LEASE
FOR JUST
\$158/Mo.*

300
MHz

64MB
RAM

8.0GB
Hard Drive

14.1"
TFT DISPLAY

10
Base-T
Ethernet

S
Video
Output

Think different... Think www.zones.com!

Modems

- 13079 Performantz 56k PC Card Fax/mod Mac \$119.98
- 0385 SupraExpress 56e D/F For Mac \$94.98*
- *Price after \$20 mail-in rebate. Exp. 12/31/98.
- 0339 Teleport 56k v.90 ext Fax/Modem for Mac \$129.98
- 0313 3Com/USR 56k v.90 D/F for Mac \$97.98*
- *Price after \$50 mail-in rebate. Exp. 1/31/99.
- 6229 Viking 56k v.90 external fax/modem \$99.98
- 84690 Global Village 56k v.90 PC Card \$169.98

Input

- 75112 Macally Two Button Mouse \$29.98
- 87464 Kensington Mouse in a Box \$39.98
- 03727 Kensington Keyboard in a Box \$49.98
- 89379 Kensington Mouse 1.0 \$59.98
- 93628 Kensington Thinking Mouse \$69.98
- 78420 Kensington Orbit \$69.98
- 87483 Kensington Turbo Mouse 5.0 \$99.98
- 85553 Adesso Touch Extended Keyboard \$39.98

- 75111 Macally MK-8000 Keyboard with Touch Pad \$72.98
- 85594 Adesso Tru-Form Ergo. Keyboard w/Touchpad \$89.98
- 75109 Macally Port Xpander \$58.98

Powerbook Essentials

- 07157 Targus Leather Notebooks \$99.98
- 07173 Samsonite Notebook System Case \$69.98
- 07175 Samsonite Notebook Compact Case \$49.98
- 42245 Kensington Saddle Bag for PB G3 (blk) \$89.98
- 07159 VST Internal Zip drive \$239.98
- 06421 Kensington Security Cable \$39.98
- 57714 HP 340 cbi portable Inkjet Printer \$329.98
- 43690 Konexx Mobile Konnecter \$119.98
- 20634 Virtual PC 98 \$168.98
- 07159 VST G3 Zip Drive \$239.98
- 82633 PB Universal Scsi Adapter \$31.98
- 00116 Norton AntiVirus 5.0 \$63.98
- 81849 DAVE 2.1 \$119.98
- 00642 PowerPrint 4.5 \$93.98
- 86331 Focus TView Gold \$399.98

- 96677 Apple Remote Access \$49.98
- 06231 Act! \$149.98
- 04890 Norton Utilities 4.0 \$94.98
- 89379 Kensington Mouse 1.0 \$59.98
- 03765 Road Rocket \$289.98
- 08640 BookEndz \$199.98
- 88753 AirDock \$64.98
- 55677 IREZ Capsure zoomed video PCMCIA \$109.98
- 55678 KritterKam \$239.98
- 44546 VST auto adapter \$78.98

Call
for your
FREE
CATALOG!

All the latest computer
products at discount prices!



Expect the Best!

Low Prices • Selection • Expertise

If for any reason you are not satisfied,
please call our No Excuses Hotline: 1-800-258-0270.

1-800-436-0606

www.zones.com

Credit cards are not charged until the order is shipped. Most products ship the same day (barring system failure, etc.). Shipping options include Ground, 2nd Day and Overnight delivery. Freight is based on average product weight. Handling extra. Insurance available. Special orders may require special shipping and handling charges. Call for international shipping rates. Prices and product availability subject to change without notice. Specials and promotions may be limited to stock on hand. Not responsible for typographical errors.

©1999 Copyright Multiple Zones International Inc. All rights reserved. Unauthorized duplication is a violation of applicable laws. Apple®, the Apple logo, Macintosh® and PowerBook® are registered trademarks of the Apple Computer, Inc.

The Mac Zone



Powerful

THE MAC ZONE'S GOT

BLOWOUT!

Outstanding performance
at an unbeatable value!

Apple® Power Macintosh®
G3/266MHz DT

While
supplies last!

ONLY \$1599
#19050

OR LEASE
FOR JUST
\$57/Mo.*

266
MHz

32MB
RAM

4.0GB
Hard Drive

24x
CD-ROM

FREE*
64MB

HURRY!
While supplies
last

Order Item
#07972

*FREE after Mr Mail-in
rebate. Memory price
will be added
to the cost of
the G3 you
select.

WITH DVD!

The ONLY Apple Desktop with DVD!

Apple® Power Macintosh®
G3/266MHz DT

Special
Purchase!

ONLY \$1749
#07880

OR LEASE
FOR JUST
\$62/Mo.*

266
MHz

64MB
RAM

4.0GB
Hard Drive

DVD
CD-ROM

56K
Flex Modem

NEW!

Includes built-in
video-in/out!

Apple® Power Macintosh®
G3/300MHz MT



ONLY \$2399
#19054

OR LEASE
FOR JUST
\$85/Mo.*

300
MHz

64MB
RAM

8.0GB
Hard Drive

24x
CD-ROM

NEW!

Includes a Zip Drive
for fast storage and backup!

Apple® Power Macintosh®
G3/300MHz DT



ONLY \$1999
#19051

OR LEASE
FOR JUST
\$71/Mo.*

300
MHz

64MB
RAM

6.0GB
Hard Drive

24x
CD-ROM

NEW!

The ultimate in performance
and flexibility at a great price!

Apple® Power Macintosh®
G3/333MHz MT

ONLY \$2999
#19055

OR LEASE
FOR JUST
\$106/Mo.*

333
MHz

128MB
RAM

9.0GB
Ultra Wide SCSI
Hard Drive

24x
CD-ROM

*Apple Business Lease: 36-month, fair-market value lease based on approved credit (\$1250 minimum lease amount). Other leasing options available. Call 1-800-611-9751 for details. Apple Commercial Credit is administered by Dana Commercial Credit Corporation. PowerPC™ and the

PowerPC logo™ are the trademarks of International Business Machines Corporation, used under license therefrom. **Extended service provided by a third party provider. Call for full details.

Check out The Mac Zone's best selling products!

| Monitors | | |
|----------|---|-----------|
| 76514 | ViewSonic GS771 17" Monitors (16" View) | \$359.98 |
| 75513 | Sony Multiscan 200ES 17" Monitors | \$379.98 |
| 76517 | Sony Multiscan 100ES 15" Monitor | \$229.98 |
| 75914 | ViewSonic Optique Q71 17" Monitor | \$249.98 |
| 76501 | ViewSonic E771 17" Monitor | \$299.98 |
| 93755 | Princeton 90 Ultra 19"/18" Monitor | \$479.98 |
| 03581 | ViewSonic PS790 19"/18" .25" SM 1600 | \$599.98 |
| 46790 | Sony Multiscan 200GS 17" Monitors | \$489.98 |
| 77049 | AppleVision 720 17" Display | \$499.98 |
| 75956 | Optique Q51 15" Monitor | \$169.98 |
| 78611 | ViewSonic Optique Q53 15" Monitor | \$174.98 |
| 46794 | Sony Multiscan 500PS 21" Monitors | \$1199.00 |
| 52829 | ViewSonic G771 17" Monitor | \$379.98 |
| 46793 | Sony Multiscan 400PS 19" Monitors | \$829.98 |
| 03774 | Optique V73 17"/16" .26 SM 1280 | \$319.98 |
| 76535 | Hitachi RasterOps Mc7515 19" Monitors | \$679.98 |
| 84147 | Viewsonic GB10 21" Color Monitor | \$979.98 |

| Printers | | |
|----------|---------------------------------------|-----------|
| 31720 | Epson Stylus 740 | \$249.98 |
| 00576 | Epson Stylus 750 | \$249.98 |
| 80668 | Epson Stylus 800 | \$219.98 |
| 00575 | Epson Stylus Photo 700 | \$249.98 |
| 00583 | Epson Stylus EX | \$499.98 |
| 40920 | Epson Stylus 1520 | \$499.98 |
| 40940 | Epson Color 3000 | \$1299.00 |
| 57715 | HP Deskjet 1120se Printer | \$598.98 |
| 82666 | HP LaserJet 6MP Printer | \$898.98 |
| 53213 | HP LaserJet 4000N Printer | \$1449.00 |
| 57728 | HP LaserJet 5000N Printer | \$2059.00 |
| 57736 | HP LaserJet 8000N Printer | \$2639.00 |
| 85467 | HP LaserJet 5M Color Printer | \$4998.00 |
| 56968 | Tektronix Phaser 360 Color Printer | \$3695.00 |
| 76646 | Tektronix Phaser 740 Color Laser | \$1995.00 |
| 76087 | Tektronix Phaser 740 Plus Color Laser | \$2695.00 |
| 74757 | Apple LaserWriter 8500 | \$1799.00 |
| 52851 | Costar Labelwriter Turbo | \$249.98 |

| Scanners | | |
|----------|--|-----------|
| 18516 | Umax Astra 1220S SCSI Flatbed Scanners | \$149.98* |
| | *After \$20 Mr Mail-in Rebate. Low Zone Price \$179.98 | |
| 18354 | Umax Astra 610s Flatbed Scanner | \$99.98* |
| | *After \$20 Mr Mail-in Rebate. Low Zone Price \$119.98 | |
| 18363 | Umax Astra 1200s w/Photoshop LE | \$249.98* |
| | *After \$50 Mr Mail-in Rebate. Low Zone Price \$299.98 | |
| 72396 | Microtek ScanMaker V600 i/Mac | \$119.98 |
| 98653 | Umax Astra 1200 w/Photo Dlx/PageManager | \$199.98* |
| | *After \$50 Mr Mail-in Rebate. Low Zone Price \$249.98 | |
| 40937 | Umax Astra600/1200 Transparency Adapter | \$189.98 |
| 56912 | Linotype Jade2 Full Photoshop 4.0 | \$499.98 |
| 53990 | Microtek Scanmaker V310 Flatbed Scanner | \$79.98 |
| 00540 | Umax Astra 1220S/P Transparency Adapter | \$199.98 |
| 18393 | Umax Powerlook II w/Photoshop LE | \$895.98* |
| | *After \$200 Mr Mail-in Rebate. Low Zone Price \$1095.00 | |
| 58476 | Linocolor Saphir w/TMA/VisualLab | \$1099.00 |
| 02135 | AGFA Arcus II Scanner w/Photo Shop 4.0 | \$1219.00 |

| Processor upgrades | | |
|-----------------------------|------------------------------------|-----------|
| Powerbook Upgrades | | |
| 33512 | NuPower G3 250MHz i/PowerBook 1400 | \$699.98 |
| 03516 | NuPower G3 240MHz i/PowerBook 2400 | \$849.98 |
| PowerMac Upgrades | | |
| 60439 | MAXpwr G3 220MHz/110 | \$449.98 |
| 60408 | MaxPwr G3 250MHz | \$529.98 |
| 94400 | MAXpwr G3 333/166 | \$1229.00 |
| 94403 | MAXpwr G3 366/183 | \$1499.00 |
| PowerMac G3 Upgrades | | |
| 94405 | MAXpwr G3 333/166 | \$1229.00 |
| 94406 | MAXpwr G3 366/183 | \$1499.00 |
| 94409 | MAXpwr G3 400/200 | \$1999.00 |
| Sonnet Technologies | | |
| 03524 | Crescendo G3 266MHz | \$599.98 |
| 03526 | Crescendo G3 300MHz | \$799.98 |
| 78928 | Crescendo G3 PowerPC 333MHz | \$999.98 |
| 78934 | Crescendo G3 PowerPC 360MHz | \$1199.00 |

we're open
hours a day
24/7
days a week

NO SURCHARGE
ON CREDIT
CARDS

Corporate bids welcome! Fax to 1-800-684-8080

1-800-436-0606 www.zones.com

Source Code
MW9901

A NASDAQ COMPANY Ticker Symbol: MZO

Packages!

A GIFT FOR YOU: 64MB FREE*!



OS 8.5 is *Here!*

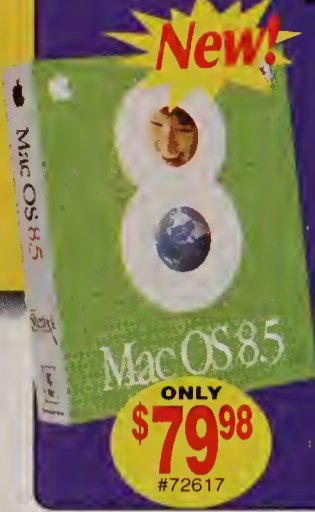

Get Mac OS 8.5 for ONLY \$79.98

with your \$100 (or more) Mac Zone purchase!
Otherwise, get it for our Low Zone Price of \$89.98

Think different.

Monitor sold separately.

Global Village Teleport 56K V.90 Fax/modem
ONLY \$99.98
with purchase of any Power Mac Desktop or Minitower
Call for details!

G3 Power Macintosh® Series Memory Upgrades

| SDRAM TYPE NEEDED | ITEM # | ONLY |
|-------------------------------|--------|----------|
| 16MB SDRAM | #54480 | \$14.98 |
| 32MB SDRAM | #54481 | \$74.98 |
| 64MB SDRAM | #54482 | \$184.98 |
| 128MB SDRAM | #54483 | \$364.98 |
| VRAM 2MB SGRAM Upgrade | #53736 | \$29.98 |
| 4MB SGRAM Upgrade | #53737 | \$34.98 |

Think different...Think www.zones.com!

UPS/Power

| | | |
|------|----------------------------------|----------|
| 933 | APC Back-UPS 200 | \$89.98 |
| 931 | APC Back-UPS 300 | \$99.98 |
| 930 | APC Back-UPS 500 | \$149.98 |
| 929 | APC Back-UPS 650 | \$229.98 |
| 595 | APC Back-UPS Office | \$79.98 |
| 5744 | PK Electronic BlackoutBuster UPS | \$99.98 |
| 0923 | APC Back-UPS Pro 280 | \$149.98 |
| 0925 | APC Back-UPS Pro 420 | \$209.98 |
| 0926 | APC Back-UPS Pro 650 | \$269.98 |
| 8537 | APC Back-UPS Pro 1000 | \$389.98 |
| 6827 | APC Back-UPS Pro 1400 | \$459.98 |
| 5740 | APC Smart-UPS 420 | \$269.98 |
| 5741 | APC Smart-UPS 620 | \$339.98 |
| 7165 | APC Smart-UPS 700 | \$368.98 |
| 0410 | APC Smart-UPS 1000 | \$519.98 |
| 0411 | APC Smart-UPS 1400 | \$649.98 |
| 0419 | APC Smart-UPS 1400 Rack Mount | \$699.98 |

Networking

| | | |
|-------|---|----------|
| 91809 | FriendlyNet AAUI to 10T Adapter | \$29.98 |
| 82092 | FriendlyNet 8 Port 10T Desktop Hub | \$55.98 |
| 70490 | AsanteFAST 10/100 PCI | \$46.98 |
| 82091 | FriendlyNet 5 Port 10T Desktop Hub | \$49.98 |
| 87016 | Asante MacCon CS 10T CommSlot | \$69.98 |
| 93330 | Micro AsantePrint 10T | \$149.98 |
| 02505 | Asante MCILC 10T LC PDS | \$84.98 |
| 91817 | Asante 8 Port 10T Hub (AUI/BNC) | \$99.98 |
| 94143 | Asante MGINB NuBus 10T/TK (RJ45/AUI) | \$109.98 |
| 16630 | AsanteTalk 10T to LocalTalk | \$99.98 |
| 91818 | Asante 12 Port 10T Hub (AUI/BNC) | \$149.98 |
| 91819 | Asante 24 Port 10T Hub (AUI) | \$255.98 |
| 50793 | FriendlyNet 8+2 Switch f/Small Netwrks | \$299.98 |
| 12290 | AsanteFAST 10/100 Nubus | \$239.98 |
| 50794 | FriendlyNet 8+2 Switch Plus f/Lrg Ntwrk | \$385.98 |
| 11926 | FriendlyNet 2 Port 10/100 Switch | \$195.98 |
| 15877 | FriendlyNet 4 Port 10/100 Switch | \$214.98 |
| 15878 | FriendlyNet 8 Port 10/100 Switch | \$424.98 |

| | | |
|-------|---|-----------|
| 50517 | IntraStack 6014DSB Switch 12 10/100 | \$1769.00 |
| 50728 | Asante Mini AUI to 10FL Transceiver | \$189.98 |
| 50515 | IntraSwitch 5324 24 Port 10T (1 10/100) | \$1139.00 |
| 09414 | AsanteFAST 10/100 PCI 5Pk | \$229.98 |
| 93331 | Micro AsantePrint 10T/TK/TN | \$159.98 |
| 03945 | Asante Mini AUI to 10T Transceiver | \$69.98 |
| 33268 | Apple Network Assistant | \$369.98 |
| 78312 | AppleShare IP 6.0 upgrade | \$439.98 |
| 73952 | PC MacLAN for NT | \$198.98 |
| 36083 | PC MacLAN for Win 95/98 | \$159.98 |

Call for your **FREE CATALOG!**

All the latest computer products at discount prices!



Expect the Best!

Low Prices • Selection • Expertise

If for any reason you are not satisfied, please call our No Excuses Hotline: 1-800-258-0270.

1-800-436-0606

www.zones.com

Credit cards are not charged until the order is shipped. Most products ship the same day (barring system failure, etc.). Shipping options include Ground, 2nd Day and Overnight delivery. Freight is based on average product weight. Handling extra. Insurance available. Special orders may require special shipping and handling charges. Call for international shipping rates. Prices and product availability subject to change without notice. Specials and promotions may be limited to stock on hand. Not responsible for typographical errors.

©1999 Copyright Multiple Zones International Inc. All rights reserved. Unauthorized duplication is a violation of applicable laws. Apple, the Apple logo, Macintosh® and PowerBook® are registered trademarks of the Apple Computer, Inc.

The Mac Zone

Enhance &

Shop The Mac Zone for



Order with Confidence!

- Guaranteed Low Prices
- Shop and order Online
- Order 24 hours a day, 7 days a week
- Serving Mac enthusiasts since 1986
- Publicly traded NASDAQ company (MZON)
- Complete Mac product selection – call for products not listed
- Affordable leasing options
- Tech Support and Customer Service

OS 8.5 is *Here!*



ONLY \$79.98*
#72617

Get Mac OS 8.5 for **ONLY \$79.98***

*with your \$100 (or more) Mac Zone purchase!
Otherwise, get it for our Low Zone Price of **\$89.98**

Virtual PC 2.1 w/Windows 98



Hewlett-Packard Laserjet 6MP Printer



ONLY \$898.98
#82666



ONLY \$118.98
#07540
Adobe Illustrator 8 Upgrade w/Color Trends
#07541 Adobe Illustrator 8 (full version) w/Upgrade Color Trends \$369.98



ONLY \$129.98
#60339
Global Village TelePort 56K v.90 Ext. Fax/Modem



ONLY \$367.98
#03858

Palm III Connected Organizer

Check out The Mac Zone's best selling products!

| Business Software | |
|-------------------|--|
| 55871 | MS Office 98-Mac \$449.98 |
| 55870 | MS Office 98 Upgrade \$259.98 |
| 93952 | Adobe Acrobat 3.0.1 \$184.98 |
| 55872 | MS Office 98 Upgrade Gold Edition Mac \$359.98 |
| 55873 | MS Office 98-Gold Edition Mac \$539.98 |
| 08329 | Appleworks \$87.98 |
| 55868 | MS Word 98 Upgrd - Mac \$134.98 |
| 50930 | Power Secretary Power Edition \$285.98 |
| 04161 | MS Project 4.0 For Mac \$424.98 |
| 55869 | MS Word 98 - Mac \$364.98 |
| 06231 | Act! 2.8 f/Mac \$149.98 |
| 80582 | Now UpToDate/Contact, Pblshr, Synze 3.65 \$88.98 |
| 03972 | Corel WordPerfect 3.5.1 \$159.98 |
| 96801 | Farallon Timbuktu Pro 4.0 Twin Pack \$184.98 |
| 96676 | Apple Remote Access Personal Server 3.0 \$115.98 |

| Utilities | |
|-----------|---|
| 87067 | Micromat TechTool Pro 2.11 \$94.98 |
| 77998 | Connectix Virtual PC 2.0 95 \$138.98 |
| 20634 | Connectix Virtual PC 2.1 98 \$138.98* *After \$30 Upgrade Rebate. Low Zone Price \$168.98. |
| 02077 | Virex 5.8 \$59.98 |
| 25006 | Insignia Softwindows 98 \$148.98 |
| 90375 | Speed Doubler 8 for Mac DS \$54.98 |
| 41956 | StuffIt Deluxe 5.0 \$74.98 |
| 00555 | Hard Disk ToolKit 2.5 \$117.98 |
| 32550 | Connectix Triple Pack: includes RAM Doubler 8, Speed Doubler 8, Surf Express Deluxe \$84.98 |
| 32558 | Retrospect 4.1 \$149.98 |
| 73702 | RealPC \$69.98 |
| 91300 | Conflict Catcher 8 \$42.98 *After \$30 Mfr Mail-in rebate for upgraders. |
| 00642 | PowerPrint 4.0 \$93.98 |
| 84048 | RAM Doubler 8 \$45.98 |
| 00116 | Norton AntiVirus 5.0 \$23.98* *After \$40 Mfr Mail-in rebate for upgraders. |

| Games | |
|-------|--|
| 74149 | ShangHai Dynasty \$39.98 |
| 72741 | Carmaggedon \$29.98 |
| 41484 | Tomb Raider 2 \$48.98 |
| 34779 | Myth 2: SoulBlighter \$49.98 |
| 49279 | Diablo \$46.98 |
| 82303 | WarCraft/Battlechest \$29.98 |
| 82936 | Eric's Ultimate Solitaire \$38.98 |
| 85760 | Sim City 2000: Special Edition \$18.98 |
| 72734 | FA 18-Hornet \$44.98 |
| 74846 | Civilization 2 \$28.98 |
| 07420 | Deer Hunter \$19.98 |
| 53467 | Jack Nicholas 4 \$44.98 |
| 74847 | Quake \$27.98 |
| 53465 | Real Pool \$16.98 |
| 07419 | Unreal \$42.98 |
| 74166 | Riven: The Sequel to Myst \$39.98 |
| 07427 | Extreme Mac 12-Pack \$39.98 |
| 60056 | Titanic \$31.98 |

| Education | |
|-----------|--|
| 90081 | Bailey's Book House \$19.98 |
| 90082 | Millie's Math House \$19.98 |
| 35184 | Math Munchers Deluxe \$19.98 |
| 90003 | The Way Things Work 2 \$26.98 |
| 505005 | KidDesk Internet Safe \$26.98 |
| 90034 | Grammar Games \$29.98 |
| 74175 | Math Blaster Algebra \$29.98 |
| 74177 | Math Blaster Pre Algebra \$29.98 |
| 71234 | Looking and Thinking \$29.98 |
| 74251 | Professor Finkle's Times Table Factory \$29.98 |
| 71251 | Mavis Beacon Teaches Typing 9.0 \$36.98 |
| 80635 | Family Tree Maker Deluxe II \$79.98 |
| 60197 | ADAM Deluxe: The Inside Story \$39.98 |
| 74199 | Oregon Trail 3 \$49.98 |
| 77404 | Design your Own Home 3D Walkaround \$69.98 |
| 79710 | Encyclopedia Britannica 1999 CD \$69.98 |
| 05984 | Reunion 5.0: Family Tree \$99.98 |
| 46434 | Complete National Geographic: 109 Years \$169.98 |

we're open 24 hours a day 7 days a week



Corporate bids welcome! Fax to 1-800-684-8080

1-800-436-0606 WWW.ZONES.COM

Source Code **MW9901**

A NASDAQ COMPANY Ticker Symbol: MZON

Expand Your Mac!

Low Prices, Selection and Expertise!

Access Anything on the Internet
Industry-Standard File Compression

Stuffit Deluxe 5.0

ONLY \$74⁹⁸
#41956

Microsoft Office 98 Upgrade

ONLY \$259⁹⁸
#55870

ViewSonic E771 17" (16" viewable) Monitor

ONLY \$299⁹⁸
#76501

NEW!

ONLY \$49⁹⁸
#34779

Myth II: SoulBlighter

Sony Mavica FD91

3x optical zoom

ONLY \$999⁹⁸
#93851

PRODUCT SHOWN IS REPRESENTATIONAL ONLY.

W/FREE 10-Pack of Sony floppy disks!

QuarkXPress 4.0

ONLY \$689⁹⁸
#95320

Norton Utilities 4.0

ONLY \$46⁹⁸*
#04890

After \$50 Mail-in rebate for upgraders. Low Zone Price \$96.98.

#00116 Norton AntiVirus 5.0 \$23.98*
*After \$40 Mfr Mail-in rebate for upgraders. Low Zone Price \$63.98.

newertech

G3 Upgrades

Mac Zone Exclusive!

Newer G3 PPC 275/138 512K backside

ONLY \$599⁹⁸
#28866

#60416 Newer MAXpower G3 f/Mac6100 240MHz/1MB **\$699.98**

#60418 Newer MAXpower G3 f/Mac7100 8100 240MHz **\$799.98**

Macromedia Director 7 Shockwave Studio

ONLY \$498⁹⁸
#86007

Microtek ScanMaker X6EL 36-bit Scanner

ONLY \$239⁹⁸
#18400

Epson Stylus Color 3000 Color Printer

NEW LOW PRICE! \$1299
#76985

*PRODUCT SHOWN IS REPRESENTATIONAL ONLY

Think different... Think www.zones.com!

| Internet | | |
|----------|---|----------|
| 77533 | Macromedia Flash 3 Upgrade | \$98.98 |
| 7551 | Dreamweaver 2 Upgrade & Fireworks 8 Bundle | \$224.98 |
| 7552 | Dreamweaver 2 Full Version & Fireworks Bundle | \$398.98 |
| 7535 | Dreamweaver 2 Upgrade | \$124.98 |
| 73486 | Macromedia Dreamweaver 2 | \$298.98 |
| 77546 | Adobe ImageReady | \$199.98 |
| 14182 | GoLive CyberStudio 3.1 Professional Edition | \$128.98 |
| 38414 | Adobe PageMill 3.0 | \$98.98 |
| 71964 | NetObjects Fusion 3.0 Upgrade | \$98.72 |
| 71916 | GoLive CyberStudio 3.1 Professional Edition | \$289.98 |
| 76471 | Bare Bones SW 88Edit 4.5 | \$99.98 |
| 71925 | DeMorgan WebSpace Animation | \$78.98 |
| 83320 | Microsoft FrontPage | \$139.98 |
| 71243 | PANTONE ColorSuite for Internet | \$74.98 |
| 46740 | Totally Hip Web Painter | \$69.87 |
| 71945 | WooTech Voyager Professional Edition 2.5 | \$99.98 |
| 71925 | WebSpace Animations | \$79.98 |
| 46747 | WebSpace 1,000,000 | \$79.98 |

| Graphics | | |
|----------|---|----------|
| 83084 | Adobe Photoshop 5.0 Upgrade | \$184.98 |
| 95320 | QuarkXPress 4.0 | \$689.98 |
| 88205 | Adobe Illustrator 8.0 Upgrade | \$118.98 |
| 71273 | Adobe Graphic Studio | \$949.98 |
| 83068 | Adobe Pagemaker 6.5 Upgrade | \$118.98 |
| 84242 | Macromedia FreeHand 8 Upgrade | \$148.98 |
| 86007 | Director 7 Shockwave Internet Studio Upgrade | \$498.98 |
| 72974 | QuarkXPress 4.0 Upgrade | \$298.98 |
| 95334 | Adobe Premiere 5.0 Upgrade | \$189.98 |
| 71172 | CorelDraw 8.0 Suite Upgrade | \$99.98* |
| | *After \$50 Upgrade Rebate. Low Zone Price \$149.98 | |
| 92266 | Director 7 Shockwave Internet Studio | \$988.98 |
| 83930 | Adobe Type Manager Deluxe 4.0 | \$64.98 |
| 89657 | PANTONE Color Survival Kit | \$154.98 |
| 72981 | Metacreations Painter 5.5 Web Edition Upgr from 5.0 | \$74.98 |
| 53567 | Metacreations Painter 5.5 Web Ed Full ver. | \$279.98 |
| 59682 | Kai's SuperGoo | \$44.98 |

| | | |
|-------|---------------------------------|----------|
| 06668 | Kai's Power Tools 5.0 | \$124.98 |
| 71245 | Extensis QXTools 4.0 Upgrade | \$49.98 |
| 77498 | Nova Art Explosion 250,000 | \$99.98 |
| 53541 | Extensis PhotoFrame Vol I & II | \$198.98 |
| 72905 | 8ryce 3D 3.0 | \$179.98 |
| 00815 | Metacreations Infini-D 4.5 | \$538.98 |
| 91289 | Metacreations Poser 3.0 | \$179.98 |
| 71241 | PANTONE ColorSuite for Graphics | \$229.98 |
| 71129 | PANTONE ColorReady | \$94.98 |
| 58511 | Extensis MaskPro 2.0 | \$278.98 |
| 72714 | MacPublisher | \$17.98 |

Call for your **FREE CATALOG!**

All the latest computer products at discount prices!

Credit cards are not charged until the order is shipped. Most products ship the same day (barring system failure, etc.). Shipping options include Ground, 2nd Day and Overnight delivery. Freight is based on average product weight. Handling extra. Insurance available. Special orders may require special shipping and handling charges. Call for international shipping rates. Prices and product availability subject to change without notice. Specials and promotions may be limited to stock on hand. Not responsible for typographical errors.

©1999 Copyright Multiple Zones International Inc. All rights reserved. Unauthorized duplication is a violation of applicable laws. Apple, the Apple logo, Macintosh and PowerBook are registered trademarks of the Apple Computer, Inc.

The Mac Zone

Expect the Best!
Low Prices • Selection • Expertise

If for any reason you are not satisfied, please call our No Excuses Hotline: 1-800-258-0270.

1-800-436-0606 **www.zones.com**

CDWTM

Computing Solutions Built for BusinessTM

CDW[®]: a one-stop resource for everything you need.

NEW! Apple[®] Mac OS 8.5

- Includes Sherlock—your personal search detective
- Access multiple Internet search engines simultaneously
- Faster network performance
- PowerPC native AppleScript
- Automate nearly any task on your computer, including Finder and Sherlock functions
- Launch scripts automatically with folder actions

\$89.97 CDW 134030

NEW! Apple[®] Power Macintosh[®] G3

- 300MHz PowerPC™ G3 processor
- 1MB backside Level 2 cache
- 64MB RAM
- 6GB hard drive
- 24X CD-ROM drive
- Integrated iomega Zip drive

Monitor sold separately

\$1999.00 CDW 124952

Apple[®] Power Macintosh[®] G3/266 desktop

- 32MB RAM
- 4GB hard drive
- 24X CD-ROM



Apple[®] iMac

- 233MHz PowerPC™ G3 processor
- 512K backside Level 2 cache
- 32MB SDRAM standard, expandable to 128MB
- 4GB IDE hard drive
- 24X CD-ROM drive
- 56K bps (K56flex and V.90) modem
- 10/100BASE-T Ethernet
- Mac OS 8.1
- 15" (13.8" viewable) high-quality display

\$1299.00 CDW 135728

Authorized Catalog Reseller

Zip USB Pack Includes:

- Zip drive
- 10 pack of 100MB Zip diskettes
- Zip mini-carrying case

\$249.95 CDW 135798



iomega External Zip USB drive **\$149.95** CDW 133411

Imation LS-120 SuperDrive USB **\$149.99** CDW 123628

Simple Technology 32MB RAM upgrade **\$83.10** CDW 126225

Umax Astra 1220U USB scanner **\$149.00** CDW 129492

AsanteTALK Ethernet connection **\$99.01** CDW 124358

Epson Stylus 740 USB inkjet printer **\$279.00** CDW 125117

COMPUTERS

- Apple[®] iMac Series**
- 233MHz PowerPC G3 32MB 4GB 24X...**1299.00**
- Apple[®] Power Macintosh[®] Series**
- 266MHz PowerPC G3 32MB 4GB 24X desktop...**1599.00**
 - 300MHz PowerPC G3 64MB 8GB 24X desktop...**1999.00**
 - 300MHz PowerPC G3 64MB 8GB 24X iomega Zip drive minitower...**2399.00**
 - 333MHz PowerPC G3 128MB 9GB 24X mini-tower...**2999.00**
- Apple[®] Power Macintosh[®] Server G3 Series**
- 300MHz PowerPC G3 64MB 4GB 24X CD 10/100 ENET...**2999.00**
 - 333MHz PowerPC G3 128MB 2x9GB 24X CD 10/100 ENET...**4599.00**
- Apple[®] Macintosh[®] PowerBook[®] Series**
- 233MHz PowerPC G3 32MB 2GB 14.1" AM 20X...**2799.00**
 - 266MHz Power PC G3 64MB 4GB 14.1" AM 20X...**3499.00**
 - 300MHz Power PC G3 64MB 8GB 14.1" AM DVD...**4999.00**
 - 300MHz Power PC G3 64MB 8GB 14.1" AM 20X...**4499.00**
- AM = active-matrix display DS = dual-scan display

- IMMICO**
- Ultimate Rez 2D/3D 8MB PCI...**468.80**
 - ix3D Pro Rez 8MB PCI Power Mac...**287.91**
 - Twin Turbo 8MB PCI Power Mac...**417.32**
 - Turbo TV video capture PCI...**98.86**

COMMUNICATIONS

- 3Com**
- Megahertz 33.6 Ethernet 10BT PC Card w/RJ11...**314.18**
 - Courier I-modem...**346.82**
- QUSAR**
- TelePort 56K V.90 external...**134.03**
 - 56K bps fax/modem PC Card...**179.09**
 - 56K bps fax/modem/Ethernet PC Card...**218.66**
- 3Com U.S. Robotics**
- Sportster 33.6 external...**106.71**
 - Sportster 56K Faxmodem external...**147.99**

DATA STORAGE

- iomega**
- Zip drive 100MB external USB if iMac...**149.95**
 - Zip drive 100MB external...**119.95**
 - Zip drive 100MB internal...**119.95**
 - ZipPlus drive 100MB external...**169.95**
 - 100MB Zip disk 3-pack...**49.95**
 - Jaz drive 1GB external...**299.95**
 - Jaz drive 2GB internal...**399.95**
 - Jaz drive 2GB external...**399.95**
 - 1GB Jaz disk 3-pack...**269.95**

LACIE

- 36X CD external...**159.00**
 - 4X8 CD-Recordable external...**499.00**
 - 4X2X6 External CD-ReWritable drive...**669.00**
 - 2.1GB Quantum Ultra SCSI-3 internal...**209.00**
 - 3.2GB Quantum ST Ultra SCSI-3 int...**229.00**
 - 6.4GB Quantum ST Ultra SCSI-3 internal...**419.00**
 - 9.1GB Quantum Ultra SCSI-3 internal...**529.00**
 - 3GB Apple drive Ultra SCSI-3 external...**379.00**
 - 4GB Apple drive Ultra SCSI-3 external...**419.00**
- Quantum**
- 3.2GB Fireball SE Ultra SCSI-3...**276.26**
 - 4.3GB Fireball SE Ultra SCSI-3...**304.59**
 - 6.4GB Fireball SE Ultra SCSI-3...**403.76**
 - 8.4GB Fireball SE Ultra SCSI-3...**519.27**

IMATION

- USB 120MB SuperDisk drive for iMac...**149.99**

SCANNERS

- AGFA**
- SnapScan 1236S scanner...**248.79**
 - SnapScan 310 flatbed scanner...**95.70**
 - SnapScan 600 Art Line flatbed scanner...**283.91**
- EPSON**
- Expression 636 Executive 2 scanner...**599.00**
 - Expression 636 Artist scanner...**799.00**
 - Expression 636 Professional scanner...**1199.00**
 - Expression 836XL scanner...**2499.00**

MICROTEK

- ScanMaker E3 Plus scanner...**127.48**
- ScanMaker 9600XL scanner...**1425.40**
- ScanMaker X6 scanner...**154.43**

Polaroid

- SprintScan 35LE film scanner...**696.75**
- SprintScan 35+ film scanner...**1508.22**

MONITORS

- ColorSync 17 17" (16.1" view) 0.26mm...699.00**
- ColorSync 20 20" (19" view) 0.26mm...1499.00**
- MultipleScan 720 17" (16" view) 0.28mm...499.00**

MITSUBISHI DISPLAY PRODUCTS

- 87TXM 17" (16" view) 0.25mm AG...**519.05**
- 91TXM 21" (19.7" view) 0.28mm AG...**1063.84**

PHILIPS MAGNAVOX

- MV5011 15" (14" view) 0.28mm...**168.74**
- 107S 17" (16.2" view) 0.28mm...**308.80**
- 109S 19" (17.9" view) 0.26mm...**519.31**

NEC

- A500 15" (13.8" view) 0.28mm...**228.99**
- E500 15" (13.8" view) 0.25mm...**276.76**
- A700 17" (15.6" view) 0.28mm...**384.36**
- E700 17" (15.6" view) 0.25mm...**528.98**
- P750 17" (15.6" view) 0.25mm...**668.14**
- E900 19" (18" view) 0.28mm...**595.04**
- MultiSync P 1250+ 21" (19.6" view) 0.28mm...**1094.653**

SONY

- 100ES 15" (14" view) 0.25mm...**235.31**
- 200ES 17" (16" view) 0.25mm...**394.56**
- 400PS 19" (18" view) 0.27mm...**839.31**
- 500PS 21" (19.8" view) 0.26mm...**1243.65**

ViewSonic

- GS771 17" (16" view) 0.27mm...**379.23**
- G790 19" (18" view) 0.26mm...**587.64**
- G800 20" (18.4" view) 0.28mm...**989.27**
- G810 21" (20" view) 0.25mm...**983.71**
- P775 17" (16" view) 0.25mm...**508.60**
- PS790 19" (18" view) 0.25mm...**707.69**
- PT813 21" (20" view) 0.28mm AG...**1108.64**
- P815 21" (20" view) 0.25mm...**1218.17**

VIDEO BOARDS

ATI

- Nexus GA 8MB PCI...**497.78**
- Xclaim TV external TV tuner...**86.82**
- Xclaim VR 4MB PCI...**248.98**
- Xclaim 3D RAGE PRO 4MB PCI...**179.38**
- Xclaim 3D RAGE PRO 8MB PCI...**234.03**

DIGITAL IMAGING

AGFA

- ePhoto 307 digital camera...**247.35**
- ePhoto 1280 digital camera...**599.05**

Nikon

- Coolpix 600 digital camera...**378.86**
- Coolpix 900 digital camera...**627.99**

UPS SYSTEMS

APC

- Back-UPS 200...**89.24**
- Back-UPS 500...**149.99**
- Smart-UPS 420 w/PowerChute software...**239.15**
- Smart-UPS 700NET...**358.55**
- Smart-UPS 1000NET...**489.24**
- Smart-UPS 1400NET...**628.50**
- SurgeArrest P7 Home...**13.00**
- SurgeArrest Personal...**24.53**
- SurgeArrest Pro...**30.57**
- SurgeArrest Network...**32.21**

UMAX

- Astra 610S flatbed scanner...**99.00**
- Astra 1200S flatbed scanner w/full Adobe PhotoDeluxe...**249.00**
- PowerLook II Duo Advance flatbed scanner...**1095.00**
- Mirage IIs flatbed scanner w/MagicScan software...**2595.00**

PRINTERS

EPSON

- Stylus Color 800...**249.00**
- Stylus Color 850...**349.00**
- Stylus Color 1520...**499.00**
- Stylus Color 3000...**1299.00**
- Stylus Photo 700...**249.00**
- Stylus Photo Ex...**499.00**

HEWLETT PACKARD

- HP DeskJet 340 portable ink jet printer...**277.08**
- HP DeskJet 1120Cse printer...**499.00**
- HP DeskJet 1600CM printer...**1918.99**
- HP LaserJet 6MP printer...**919.40**
- HP LaserJet 4000N printer...**1389.99**
- HP LaserJet 8000DN printer...**3188.35**

CDW[®] DIRECTORY

| | |
|--------------------------------|--------------|
| PC sales | 800-800-4239 |
| Mac sales | 800-509-4239 |
| Corporate sales | 800-280-4239 |
| Corporate software sales | 800-294-4239 |
| Government and Education sales | 800-808-4239 |
| Networking sales | 800-377-4239 |

CDW[®] TELEPHONE HOURS

| |
|--|
| Sales |
| Monday-Friday 7 a.m.-9 p.m. CT |
| Saturday 9 a.m.-5 p.m. CT |
| Tech Support>Returns for Customers |
| 800-383-4239 |
| Monday-Friday 7 a.m.-9 p.m. CT |
| Saturday 9 a.m.-5 p.m. CT |

BUY WITH CONFIDENCE CDW[®] IS A NASDAQ TRADED COMPANY
TICKER SYMBOL CDWC D & B rated 5A1

Credit card charges are not submitted until time of shipment. For your protection, we ship only to your credit card's verified billing address. Shipping and handling charges apply; please ask your CDW account manager for details. Before returning any product, you must obtain an RMA number. Non-defective returns are subject to a restocking fee. Software, chips and other electronic components are not returnable. Allow 10 business days for shipping when paying by personal check. All pricing subject to change. For all prices, products and offers, CDW reserves the right to make adjustments due to changing market conditions, product discontinuation, manufacturer price changes, errors in advertisements or other extenuating circumstances. All trademarks and registered trademarks are the sole property of their respective owners.

800-509-4239
www.cdw.com

©1998 CDW[®] Computer Centers, Inc. 200 N. Milwaukee Avenue, Vernon Hills, IL 60061 MW4184 1/99

56K modems are capable of 56K bps downloads, however, current regulations limit download speed to 53K bps.

Internet connectivity requires access services from an Internet access provider.

Choose 2 at www.macworld.com/getinfo

Contact your local access provider for rates, terms and conditions.

ALWAYS FREE DELIVERY

90 Day

Performance Guarantee

A winner all the way around in terms of speed, value and design
-MacWorld 6/96

EDITOR'S CHOICE

EDITOR'S CHOICE

BEST BUY

BEST BUY

"If you're a desk-top-video or graphics professional, you need not only a lot of capacity but also alot of speed... The 9-GB ProDirect PD19171N... excellent choice" -MacUser 6/97

"The fastest array in this test, the ProDirect PowerRAID" -MacUser 8/97

"an outstanding value in terms of price and performance... comes with easy-to-use formatting utility" PDS19101 Seagate Cheetah 9 Gig Wide -MacWorld 3/98

HIGH PERFORMANCE SPEED-TUNE SPECIALISTS

The Difference? It's Speed-Tuning!
Working closely with drive manufacturers to identify and optimize key internal model settings for the Mac, AT, & PowerRAID our hard drives are calibrated to operate at peak efficiency. We call it Speed-Tuning™ and it works. The proof is in the words our drives keep winning.



- What you get from the Speed-Tuning Experts at ProDirect...
 - A HARD DRIVE IN A BOX THAT HAS BEEN SPEED-TUNED TO THE EXACT WAY YOU WORK
 - YOUR CHOICE OF SPEED-TUNING
 - AV RECORDING CALIBRATION
 - DESKTOP PUBLISHING CALIBRATION
 - MULTI-PURPOSE CALIBRATION
 - AWARD-WINNING PERFORMANCE
 - TECH SUPPORT FROM PROS WHO KNOW MORE THAN HOW TO PACK BOXES

ProDirect PowerStor Enclosures
All ProDirect External Hard Drives are Enclosed in our Attractive, High Performance PowerStor Cabinet.
All Drives Pre-Tested • QUIET High Power Cooling Fan
• Active Terminator
• System Complimenting, Stackable Design
• Reliable 110-220 Auto sensing 40 Watt UL, TUV, CV, Approved Power Supply
• System or Daisy Chain Cable

MAXIMIZE YOUR HARD DRIVE WITH THE RIGHT SCSI ACCELERATOR CARD!

- Adaptec ATTO**
- YOUR CHOICE: ULTRA WIDE ACCELERATOR CARD**
- PowerDomain 2940UW **\$199***
- UP TO 40 MB/Sec. *WITH ANY DRIVE PURCHASE
- Ultra SCSI Dual Channel PCI
- PowerDomain 3940 UP TO 40 MB/Sec. **\$425**
- Dual Channel Express PCI **\$549**
- Ultra 2 SCSI LVD PCI
- BACKWARDS COMPATIBLE WITH EXISTING SCSI & ULTRA SCSI
- PowerDomain 2940 U2W **\$445**
- 2 CARD, ALL CABLES, TERMINATION UP TO 80 MB/Sec.
- Express PCI LVD **\$435**

TAPE BACKUP

SONY AITSDX300C 120MB/Min. \$2389

SPEEDY TAPE DRIVES IN STOCK TODAY

| CAPACITY | MODEL | TRANSFER RATE | SALE |
|----------|-----------------|---------------|--------|
| 1 GB | STD8000 | 60 MB/Min. | 655 |
| 1 GB | Sony 7000 | 90 MB/Min. | 975 |
| 4 GB | HP1554 DDS3 | 120 MB/Min. | 1245 |
| 4 GB | Sony 9000 DD3 | 120 MB/Min. | 1195 |
| 5 GB | DLT 2000XT | 150 MB/Min. | 1695 |
| 5 GB | DLT 4000 | 180 MB/Min. | 2495 |
| 5 GB | DLT 7000 | 600 MB/Min. | 5345 |
| 44 GB | HP1559 DDS3 | 120 MB/Min. | 3395 |
| 50 GB | DLT 4500 | 180 MB/Min. | 3795 |
| 80 GB | DLT 4700 | 180 MB/Min. | 5575 |
| 60 GB | DLT Stor1144LST | 180 MB/Min. | 10,485 |
| 80GB | DLT Stor7114ST | 180 MB/Min. | 13,899 |

RETROSPECT 4.0 MAC OR CHEYENNE WINDOWS (NT)
SOFTWARE INCLUDED WITH ALL TAPE DRIVES

MEMORY DEALS

HIGHEST QUALITY APPLE CERTIFIED WITH LIFETIME WARRANTY

| | 32MB | 64MB | 128MB |
|-------------------------|-----------|-----------|-------|
| PowerMoc G3 SDRAM | \$46 | \$88 | \$182 |
| PowerMoc 168 pin DIMM | \$43 | \$88 | \$275 |
| PowerBook WallStreet G3 | \$71 | \$125 | \$245 |
| 72pin SIMM | 16MB-\$21 | 32MB-\$42 | |

DVD, CDR & CD DRIVES

- 5.2GB DVD RamDrive **\$795**
- 2X Rewritable DVD-RAM Drive. Stores up to 5.2GB/Media.
- 20X CD Reader. Reads CDROM, CD-R and CDRW!
- CD Rom Drives
- Pioneer 36x CD ROM **\$139**
- 60ms Access Caddy/less Design External
- CD Recorders
- 2x CD Rewritable 4x Recorder 6x Reader **\$455**
- Yamaha CRW4260 External with HUGE 2Mb Buffer
- Panasonic CDR 7502 4x Recorder 8x Reader External with 1Mb Buffer **\$345**
- FREE TOAST SOFTWARE INCLUDED WITH ALL CDR'S

Quantum ATLAS II
9.1GB **\$465**
(Q39100N) External: \$525
9.1GB Wide \$475
(Q39100W) External: \$565
7200RPM 1024K BUFFER 7.9MS SEEK

Quantum VIKING II
4.5GB U2/Wide **\$285**
(PX34550LW) External: \$375
9.1GB U2/Wide \$469
(PX39100LW) External: \$559
7200RPM 512K BUFFER 8.5MS SEEK

Quantum ATLAS III
9.1GB U2/Wide **\$535**
(AL309100LW) External: \$625
18.2GB U2/Wide \$975
(AL318200LW) External: \$1065
7200RPM 1024K BUFFER 7.5MS SEEK

Quantum FIREBALL
CAPACITY FOR THE EXTRAORDINARY
1.2GB **\$115**
External: \$175
6.4GB **\$355**
External: \$425
8.4GB **\$465**
External: \$535
5400rpm 512k buffer 9.5ms Seek

NEW! IDE HARD DRIVES

Quantum

- 2.5GB FB302500ELA **\$125**
- 5.1GB FB35100ELA **\$155**
- 7.6GB FB37600ELA **\$215**
- 10.2GB FB310200ELA **\$255**

5400rpm 128k buffer 10ms Seek

DIGITAL VIDEO

NEW FIREWIRE 1394 AND UltraWide SCSI Both on One Card!

Adaptec ULTRA HOT CONNECT 8945

PROFESSIONAL QUALITY DIGITAL VIDEO PLUS ULTRA WIDE SCSI PORT
Plug your FireWire equipped Camera right into your computer to easily capture digital video and stills. NTSC and PAL formats compatible

Ultra Hot Connect 8945 \$599
(WITH FIREWIRE AND ULTRAWIDE SCSI BOTH ON ONE CARD)

MEDIA 100 QX WITH ADOBE PREMIERE 5.0 **\$1795*** MAC WIN NT \$1795*

MEDIA 100 QXC WITH ADOBE PREMIERE 5.0 **\$3795*** SAVE

MEDIA 100 LE WITH DRIVE or PowerRAID PURCHASE **\$495***

TRUEVISION

- TARGA 1000 Mac/Win NT **\$1645**
- TARGA 1000 Pro NTSC Mac/NT **\$2235**
- TARGA 2000 Mac/Win NT **\$3435**
- TARGA 2000 Pro NTSC Mac/NT **\$3795**

Targa 1000 & 2000 also available in PAL format

Pinnacle

- Miromotion DC30+ **\$865** W/ PREMIERE 5.0 MAC
- Miromotion DV300 **\$735** W/ PREMIERE LE MAC/WIN

Upgrade Your Mac to G3 Power!

newer technology

| | |
|--|----------|
| MAXPOWER G3 210MHZ 512K 6100 | \$445.00 |
| MAXPOWER G3 210MHZ 512K 7100/8100 | 595.00 |
| MAXPOWER G3 220MHZ 512K 7300-9600 | 545.00 |
| MAXPOWER G3 240MHZ 1024K 6100 | 689.00 |
| MAXPOWER G3 240MHZ 1024K 7100-8100 | 789.00 |
| MAXPOWER G3 250MHZ 512K 7300-9600 | 545.00 |
| MAXPOWER G3 333MHZ 1024K/183 7300-9600 | 1235.00 |
| MAXPOWER G3 366MHZ 1024K/183 7300-9600 | 1485.00 |
| MAXPOWER G3 400MHZ 1024K/200 7300-9600 | 1975.00 |

IBM ULTRASTAR ZX
9.1GB Wide **\$575**
(39100W) External: \$665
10000RPM 1024K BUFFER 6.8MS SEEK

IBM ULTRASTAR
9.1GB Wide **\$495**
(39130W) External: \$585
18.2GB U2/Wide \$995
(318200W) External: \$1085
7200RPM 1024K BUFFER 7.9MS SEEK

ES ULTRASTAR ES
VALUE! 4.5GB **\$299**
(DDRS34560S) External: \$359
4.5GB Wide **\$299**
(DDRS34560W) External: \$389
7200RPM 512K BUFFER 8.5MS SEEK

IDE HARD DRIVES DESKSTAR GP

- 4.3GB (DHEA-34331) **\$169**
- 6.4GB (DTTA-350640) **\$199**
- 8.4GB (DTTA-350840) **\$229**
- 10.1GB (DTTA-351010) **\$259**
- 12.9GB (DTTA-351290) **\$295**
- 13.5GB (DTTA-351350) **\$315**
- 16.8GB (DTTA-351680) **\$415**

5400rpm 512k buffer 9.5ms Seek

IDE HARD DRIVES DESKSTAR GPX

- 10.1GB (DTTA-371010) **\$270**
- 14.4GB (DTTA-371440) **\$439**

7200rpm 512k buffer 9.5ms Seek

"The fastest array in this test, the ProDirect PowerRAID" -MacUser 8/97

Plug in a PowerRAID™

- All PowerRAIDs are initialized, Speed Tuned, Tested and Bench Marked To Insure a True Plug and Save Reliability.
- The Premier Adaptec 2940U2W Ultra2 Wide Accelerator (Available with Dual Channel)
 - Raid-Tuned Hard Drives
 - Raid Center Enclosures With Maximum Duty Power Supply, Teflon Shielded Cables, High Output Cooling
 - Remus Raid Software.
 - All PowerRAID components are covered by a 5 year 48 hour replacement warranty.



COMPARE FEATURE TO FEATURE AND SAVE @ PRODIRECT.

Call or visit our website for our complete line of Open System Architecture PowerRAIDs.

Seagate BARRACUDA PowerRAIDS

18GB PowerRAIDSB18

FIXED: \$1795 REMOVABLE: \$1995
LEASE FOR: \$74/MO LEASE FOR: \$82/MO

Seagate CHEETAH PowerRAIDS

18GB PowerRAIDSC18

FIXED: \$1995 REMOVABLE: \$2195
LEASE FOR: \$82/MO LEASE FOR: \$90/MO

36GB PowerRAIDSB36

FIXED: \$2995 REMOVABLE: \$3195
LEASE FOR: \$108/MO LEASE FOR: \$115/MO

36GB PowerRAIDSC36

FIXED: \$3545 REMOVABLE: \$3745
LEASE FOR: \$128/MO LEASE FOR: \$135/MO

72GB PowerRAIDSB72

FIXED: \$5995 REMOVABLE: \$6395
LEASE FOR: \$144/MO LEASE FOR: \$154/MO

72GB PowerRAIDSC72

FIXED: \$6995 REMOVABLE: \$7395
LEASE FOR: \$172/MO LEASE FOR: \$189/MO

144GB PowerRAIDSB144

FIXED: \$10,995 REMOVABLE: \$11,395
LEASE FOR: \$273/MO LEASE FOR: \$291/MO

144GB PowerRAIDSC144

FIXED: \$13,995 REMOVABLE: \$14,665
LEASE FOR: \$332/MO LEASE FOR: \$350/MO

www.pdisales.com
• Quickly find and order it now on our website!

ZIP/JAZ

Zip Drive no cartridge **\$119** INTERNAL **\$115** IOMEGA EXTERNAL

Zip Plus Drive one cartridge **\$175**

Jaz 1GB Drive one cartridge **\$279** IOMEGA **\$295**

Jaz 2GB Drive no cartridge **\$359** IOMEGA **\$349**

Media: ZIP: \$9.95 | JAZ 1GB: \$84.95 | JAZ 2GB: \$99.95

Service * Performance * Price * Always™

ProDIRECT means...

- 90 Day Performance Guarantee
- Toll-Free Tech Support
- Same Day Shipping
- No Sales Tax Outside MN
- Reseller Pricing Available
- Educ. & Govt. Discounts
- Never a Surcharge!

ProDIRECT

10830 Nesbitt Ave South Bloomington, MN 55437

Hours: Monday-Friday 8AM-7PM
International Orders: 612-884-0012
ProDirect Fax: 612-941-1109

Toll Free Tech Support 800-524-9952
Internet: www.pdisales.com
E-mail: info@pdisales.com

800-524-9952

ALL PRICES ARE SUBJECT TO CHANGE WITHOUT NOTICE. RETURNED ORDERS ARE SUBJECT TO A RESTOCKING FEE. INTERNATIONAL CUSTOMERS PAY ALL SHIPPING CHARGES. ALL SHIPPING CHARGES ARE NON-REFUNDABLE. TO RETURN MERCHANDISE CALL FOR AN RMA NUMBER. ALL RMAs MUST BE RETURNED WITHIN 10 BUSINESS DAYS OF ISSUANCE. CUSTOMERS ARE RESPONSIBLE FOR SHIPPING CHARGES TO RETURN PRODUCT.

ClubMac® SAVE BIG BUCKS

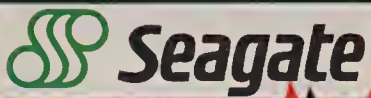

MEDALIST PRO 4.5GB 9.5MS 7200 RPM Bare

ONLY \$259



DRIVE SPECIALS

STRATUS SE

Quantum **\$359**
6.4GB
5400 RPM
Bare

BARRACUDA 9LP

Seagate **\$529**
Fast & Wide
9.1GB
7200 RPM
Bare

ULTRASTAR 18XP

IBM **\$999**
Fast & Wide
18.2GB
7200 RPM
Bare

FIREBALL EX

Quantum **\$139**
3.2GB
IDE
Bare

HARD DRIVES

Quantum

Quantum Stratus drives carry a 3 Year Warranty
Quantum Atlas & Viking drives carry a 5 Year Warranty

| Description | Model | Access | RPM | Bare | Ext |
|------------------|-------------|--------|------|--------|--------|
| 2.1GB Stratus SE | QM32160SES | 10ms | 5400 | \$209 | \$279 |
| 3.2GB Stratus SE | QM33240SES | 10ms | 5400 | \$239 | \$309 |
| 4.3GB Stratus SE | QM34320SES | 10ms | 5400 | \$279 | \$349 |
| 6.4GB Stratus SE | QM36480SES | 10ms | 5400 | \$359 | \$429 |
| 8.4GB Stratus SE | QM38420SES | 10ms | 5400 | \$479 | \$549 |
| 9.1GB Atlas III | QM309100TDS | 7.8ms | 7200 | \$569 | \$639 |
| 18.2GB Atlas III | QM318200TDS | 7.8ms | 7200 | \$1039 | \$1109 |

UltraWide SCSI-3

| | | | | | |
|------------------|--------------|-------|------|--------|--------|
| 4.5GB Viking II | QM304550PXS | 7.5ms | 7200 | \$309 | \$399 |
| 9.1GB Viking II | QM309100PXS | 7.5ms | 7200 | \$499 | \$589 |
| 9.1GB Atlas III | QM309100TDLW | 7.8ms | 7200 | \$569 | \$659 |
| 18.2GB Atlas III | QM318200TDLW | 7.8ms | 7200 | \$1039 | \$1129 |

IDE Drives

| | | | | | |
|--------------------|-------------|-------|------|-------|------|
| 3.2GB Fireball EX | QM303200EXA | 9.5ms | 5400 | \$139 | ---- |
| 5.1GB Fireball EL | QM305100ELA | 10ms | 5400 | \$159 | ---- |
| 6.4GB Fireball EX | QM306400EXA | 9.5ms | 5400 | \$179 | ---- |
| 10.2GB Fireball EL | QM310200ELA | 9.5ms | 5400 | \$259 | ---- |
| 12.7GB Fireball EX | QM312700EXA | 10ms | 5400 | \$359 | ---- |

Seagate

Barracuda & Cheetah drives carry a 5 Year Warranty
Medalist drives carry a 3 Year Warranty

Ultra SCSI-3

| | | | | | |
|---------------------|-----------|-------|------|--------|--------|
| 4.5GB Medalist Pro | ST34520N | 9.5ms | 7200 | \$259 | \$329 |
| 6.5GB Medalist Pro | ST36530N | 9.5ms | 7200 | \$369 | \$439 |
| 4.5GB Medalist Pro | ST39140N | 9.5ms | 7200 | \$489 | \$559 |
| 9.1GB Barracuda 9LP | ST39173N | 7.1ms | 7200 | \$529 | \$599 |
| 18.2GB Barracuda 18 | ST118273N | 7.1ms | 7200 | \$1029 | \$1099 |

UltraWide SCSI-3

| | | | | | |
|---------------------|------------|--------|-------|--------|--------|
| 9.1GB Barracuda 9LP | ST39173W | 7.1ms | 7200 | \$529 | \$619 |
| 9.1GB Cheetah 9LP | ST39102LW | 12.2ms | 10000 | \$749 | \$839 |
| 18.2GB Barracuda 18 | ST118273W | 7.1ms | 7200 | \$1029 | \$1119 |
| 18.2GB Cheetah 18 | ST118202LW | 12.2ms | 10000 | \$1349 | \$1439 |

IBM

IBM drives carry a 5 Year Warranty

UltraWide SCSI-3

| | | | | | |
|-----------------------|---------|-------|------|-------|--------|
| 9.1GB UltraStar 9ES | 00K3990 | 7.5ms | 7200 | \$529 | \$619 |
| 9.1GB UltraStar 9ZX | 59H6590 | 6.5ms | 1000 | \$579 | \$669 |
| 18.2GB UltraStar 18XP | 59H6591 | 6.5ms | 7200 | \$999 | \$1089 |

THE CLUBMAC PACKAGE

ClubMac drives are preformatted and thoroughly tested. ClubMac external drives include a 30-Day Money Back Guarantee, Charismatic Anubis Formatting Utility software, user's guide, 25/50-pin SCSI cable and power cord (wide drives include 68/68 pin SCSI cable). Bare drives include mounting screws only.

INTERNAL HARD DRIVE KITS

Need a bracket and formatting software for your hard drive? ClubMac Internal Hard Drive Kit's include Charismatic's Anubis Hard Drive Utility (with Power Control), a bracket and screws- ask your customer service representative which one you need.

TAPE BACK-UP

ClubMac **DDS-3 DAT Drive**
12-24GB **\$999**

CLUBMAC TAPE BACK-UP

| | |
|---|--------|
| 4-8GB DDS-2 DAT Drive w/ Retrospect 4.1 | \$729 |
| 12-24GB DDS-3 DAT Drive w/ Retrospect 4.1 | \$999 |
| 20-40GB DLT Drive w/ Retrospect 4.1 | \$2699 |
| 35-70GB DLT Drive w/ Retrospect 4.1 | \$5999 |

ClubMac **8mm AIT Drive**
Up to 25-50GB 6MB/Sec!
ONLY \$2399

CLUBMAC AIT DRIVE

| | |
|-------------------------------------|--------|
| 25-50GB 8mm AIT Drive | \$2399 |
| 25-50GB 8mm AIT w/ Fast & Wide Cord | \$2629 |

BONUS OFFER!!!
All ClubMac Tape Back-up Products are bundled with Retrospect 4.1

RETROSPECT 4.1

| | |
|--|-------|
| Retrospect 4.1 Retail Single User | \$149 |
| Retrospect 4.1 Remote 10 User License | \$175 |
| Retrospect Network Kit 4.1 (w/10 User license) | \$275 |

REMOVABLE
\$299

REMOVABLE DRIVES

| | |
|-----------------------------|-------|
| ClubMac SyQuest 200MB 5.25" | \$349 |
| SyQuest EZ Flyer 230MB 3.5" | \$149 |
| SyQuest SyJet 1.5GB 3.5" | \$299 |

SYQUEST MEDIA

| Media | Qty 1 | Qty 10 | Qty 20 |
|-------------|--------|-----------------------|--------|
| 44MB | \$38ea | \$37 ⁵⁰ ea | \$37ea |
| 88MB | \$38ea | \$37 ⁵⁰ ea | \$37ea |
| 200MB | \$54ea | \$53ea | \$52ea |
| 270MB | \$43ea | \$42ea | \$41ea |
| EZ230MB | \$27ea | \$26 ⁵⁰ ea | \$26ea |
| 1.5GB SyJet | \$79ea | CALL | CALL |

CD READERS & RECORDABLES

BLAZING FAST! CD-ROM
36X
ONLY \$159

5400KB/sec data transfer
60ms avg access time
Caddy-less design

ClubMac **\$329!**
4X/8X

Toast 3.5
Direct CD
Easy CD Creator
Mac or PC Compatible

CLUBMAC CD-RECORDERS

| | |
|--------------------------|-----|
| 4X/8X CD-R w/Software | \$3 |
| 4X/12X CD-R w/Software | \$3 |
| CLUBMAC CD-REWRITABLE | |
| 4X/2X/6X CDRW w/Software | \$3 |

THE CLUBMAC PACKAGE: ClubMac CD-ROM & CD Recorders are thoroughly tested. CD-ROM & CD Recorders include a 30-Day Money Back Guarantee, Charismatic CD AutoCache utility software, user's guide, 25/50-pin SCSI cable, terminator, and power cord.

Zip Drive Solutions

ZIP REFURB
\$89.95
100MB

Includes Tools on CD

IOMEGA ZIP DRIVES

| | |
|---|---------------------|
| Zip Drive w/Tools on CD | \$119 ⁹⁵ |
| ZipPlus™ Drive w/one cartridge | \$179 ⁹⁵ |
| Zip Bundle-drive, 11 Disks, Case, 2 Caddy's | \$259 |
| Zip Drive Internal- all PowerMacs | \$119 |
| Zip Drive Internal- all PowerComp/Umax | \$99 |

Jaz Drive Solutions

2.0GB
ONLY \$349.95

NEW LOW PRICE

IOMEGA JAZ DRIVES

| | |
|---------------------------------------|-------|
| Jaz 2GB Drive w/Tools on CD | \$349 |
| ClubMac Jaz 2GB Drive w/Tools on CD | \$379 |
| Jaz 2GB Drive Internal- all PowerMacs | \$349 |

IOMEGA MEDIA

ZIP Media
as low as **\$9.95**

as low as **\$84.95**
For JAZ media

| Format | Part# | Qty 1-2 | Qty 3-6 | Qty 7-9 | Qty 10 |
|-----------|-----------|--------------------|---------------------|--------------------|--------------------|
| ZIP 100MB | 1040 1006 | \$19 ⁹⁵ | \$15 ⁹⁵ | \$13 ⁹⁵ | \$9 ⁹⁵ |
| Format | Part# | Size | Qty 1-2 | Qty 3-5 | Qty 6- |
| JAZ 1GB | 1040 1015 | 1.0 GB | \$99 ⁹⁵ | \$89 ⁹⁵ | \$84 ⁹⁵ |
| JAZ 2GB | 1040 1074 | 2.0 GB | \$124 ⁹⁵ | \$99 ⁹⁵ | CALL |

CALL 1-800-260-8549 FOR A FREE CATALOG

WARRANTIES: All items manufactured by ClubMac are returned to ClubMac for warranty repair. All other items carry manufacturer's warranty. MONEY BACK GUARANTEE: All products manufactured by ClubMac carry a 30 day money back guarantee. ClubMac extends all other manufacturers' return policies to its customers. Non-ClubMac products carry 30 day money back guarantee when specified. RETURNS: Call for RMA number. Any product that is returned WITHOUT an RMA number will be refused. ALL PRODUCT INFORMATION AND PRICES ARE SUBJECT TO CHANGE WITHOUT NOTICE. NOT RESPONSIBLE FOR TYPOGRAPHICAL ERRORS.



Apple iMac

FREE 32MB RAM

\$1299

- 233MHz G3 Processor
- 32MB SDRAM
- 4GB Hard Drive
- 24x CD-ROM
- 512K Backside Level 2 Cache
- 56K Modem
- 2MB SGRAM

INSTANT REBATES!!

| | | |
|--|--|--|
| SAVE \$85* on any product priced between \$1599 and \$1999. | SAVE \$150* on any product priced between \$2499 and \$2998. | SAVE \$225* on any product priced between \$3499 and \$4998. |
| SAVE \$100* on any product priced between \$2000 and \$2498. | SAVE \$200* on any product priced between \$2999 and \$3498. | SAVE \$300* on any product priced between \$4999 and above. |

*Instant Rebates are valid only on products advertised in this offer. Instant Rebates are not valid with any other offer or promotion. Offer expires 10/31/98

FREE Corel DRAW 8

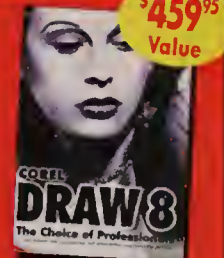

WITH ANY APPLE CPU PURCHASE
Ask for Item # PPP 1022

Offer good while supplies last. Apple CPU must be purchased at advertised catalog price. Offer good with instant rebate promotion! Offer only valid when asked for at the time of CPU purchase. Corel DRAW8 ships in promotional packaging.

PowerMac G3 Minitower

- 300MHz G3 Processor
- 64MB SDRAM
- 8GB Hard Drive
- Zip Drive
- 24x CD-ROM
- 24 bit Video In/out



\$2399

PowerMac G3 333MHz
128MB, 9GB U/W SCSI, 24X CD \$2999

PowerBook G3

- 12.1" Active Matrix Display
- 233MHz G3
- 32MB SDRAM
- 2GB Hard Drive
- 20x CD-ROM
- 1.44 Floppy
- 56K Modem



| | |
|---|--------|
| PowerBook G3 233MHz 14.1" TFT 32MB RAM, 2GB HD, 20X CD..... | \$2799 |
| PowerBook G3 266MHz 14.1" TFT 64MB RAM, 4GB HD, 20X CD..... | \$3499 |
| PowerBook G3 300MHz 14.1" TFT 64MB RAM, 8GB HD, 20X CD..... | \$4499 |
| PowerBook G3 300MHz 14.1" TFT 64MB RAM, 8GB HD, DVD-ROM..... | \$4999 |

PowerMac G3 Desktop

- 266MHz G3 Processor
- 64MB SDRAM
- 4GB Hard Drive
- 6MB VRAM
- 56K Modem
- DVD ROM

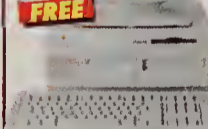

\$1749

| | |
|--|--------|
| PowerMac G3 266MHz 32MB RAM, 4GB HD, 20X CD, 10BT, 2MB VRAM..... | \$1599 |
| PowerMac G3 300MHz Desktop 64MB, 6GB HD, 20X CD, 2MB VRAM, Zip..... | \$1999 |

SOURCE CODE **69019**

ClubMac

ORDER TODAY! 24 HOURS A DAY 7 DAYS A WEEK

1-800-260-8549

Order On-line @ <http://www.clubmac.com>

Illustrator 8.0

Adobe
Illustrator 8.0
New Version!
Upgrade only
\$118⁹⁵
A030 1204

Mac OS 8.5

Full Version only
\$85⁹⁵
A109 1411

SONY 200ES 17"

106 1048
\$399

HP LASERJET 4000N

H047 1099
\$1448⁹⁵

EPSON Stylus 3000

E047 1057
\$1299

RESCENDO G3 ACCELERATOR

20 1016
300 MHz!
\$799

PINNACLE DC30

P074 1025
\$349

Teleport v.90 56K Fax/Modem

G050 1038
w/Mac OS 8.1
\$138⁹⁵
Upgrade to OS 8.5 for \$19⁹⁵

Mactell Vision3D Pro II Lite 8MB

M550 1028
\$289⁹⁵

MICROTEK ScanMaker V310

\$49
M150 1045

MONITORS

| | |
|---|--------|
| iscan 100ES 15", 1280x1024, 25mm..... | \$229 |
| iscan 100GS 15", 1280x1024, on screen disp..... | \$279 |
| iscan 200ES 17", 1280x1024, 25mm..... | \$399 |
| iscan 220GS 15", 1280x1024..... | \$499 |
| iscan 420GS 20", 1600x1200..... | \$799 |
| iscan 400PS 19", 1600x1200..... | \$859 |
| iscan 520GS 21", 1600x1200..... | \$1199 |
| iscan 500PS 21", 1600x1200..... | \$1229 |
| le ColorSync 17"..... | \$699 |
| le ColorSync 20"..... | \$1499 |
| 6215 17", 15.9 viewable 1024X768..... | \$399 |
| 7515 19", 1600x1200..... | \$699 |
| Scan MC801HR 21", 1600x1280..... | \$1349 |
| 771 17", 11280x1024, .25 dot pitch..... | \$399 |
| 775, 17" 1280x1024, 80Hz, .25 dot pitch..... | \$529 |
| 90, 19" 1600x1200, .25 dot pitch..... | \$559 |
| 813, 21" 1600x1200, 85Hz, .28 dot pitch..... | \$1149 |
| 115, 21" 1800x1440, 76Hz, .25 dot pitch..... | \$1279 |

GRAPHIC CARDS CON'T

| | |
|---|-------|
| Mac Rocket 2D/3D w/Video Out..... | \$209 |
| Pro Rez 2D/3D 128 bit 8MB PCI..... | \$299 |
| Ultimate Rez 2D/3D 8MB PCI..... | \$499 |
| Ultimate Rez 2D/3D 8MB PCI (Promo)..... | \$199 |

PRINTERS

| | |
|---|--------|
| Stylus Color 850 1440 DPI..... | \$349 |
| Stylus Color 800 1440 DPI..... | \$249 |
| Stylus Color Photo 700 6 COLOR..... | \$249 |
| Stylus Color 3000 17" x 22" 1440 DPI..... | \$1299 |

ACCELERATORS

| | |
|-------------------------------|-------|
| G3 233MHz/125/512K Cache..... | \$429 |
| G3 240-250MHz/1MB..... | \$649 |
| G3 257-266MHz/1MB..... | \$749 |
| G3 233MHz/512K Cache/PCI..... | \$349 |
| G3 266MHz/1MB Cache/PCI..... | \$599 |
| G3 300MHz/1MB Cache/PCI..... | \$799 |

SOFTWARE

| | |
|------------------------------|----------|
| Mac OS 8.5..... | \$85.95 |
| Mac OS 8.5 10 User..... | \$819.95 |
| Photoshop 5.0 Upgrade..... | \$179.95 |
| Illustrator 8.0 Upgrade..... | \$119.95 |
| Virtual PC 2.1 w/Win98..... | \$138.95 |
| Office 98 Upgrade..... | \$263.95 |
| QuarkXPress 4.0..... | \$698.95 |

SCANNERS

| | |
|--|-------|
| Agfa SnapScan 310 30 bit scanner..... | \$199 |
| Agfa Arcus T1200 36 bit twin plate scanner..... | \$699 |
| UMAX Astra 610S..... | \$99 |
| UMAX Astra 1220U, 36 bit USB scanner..... | \$129 |
| UMAX Powerlook II w/trans. adapter..... | \$895 |
| Microtek Scanmaker 4, Dual Platform, 36 bit..... | \$699 |
| Microtek Scanmaker V600, 30bit..... | \$109 |
| Microtek Scanmaker V310, 30bit..... | \$49 |

MODEMS

| | |
|----------------------------------|----------|
| Teleport V.90 56K Fax/Modem..... | \$138.95 |
| 56K V.90 FAX/Modem External..... | \$149.95 |
| 56K V.90 PCMCIA FAX/Modem..... | \$99.00 |

MEMORY UPGRADES

| | |
|-------------------|-------|
| 72pin SIMMs | |
| 4MB..... | \$15 |
| 8MB..... | \$25 |
| 16MB..... | \$55 |
| 32MB..... | \$99 |
| 168 pin DIMMs | |
| 16MB..... | \$49 |
| 32MB..... | \$109 |
| 64MB..... | \$209 |
| 128MB..... | \$389 |
| PowerMac G3 DIMMs | |
| 16MB..... | \$45 |
| 32MB..... | \$59 |
| 64MB..... | \$129 |
| 128MB..... | \$259 |
| PowerBook G3 | |
| 16MB..... | \$65 |
| 32MB..... | \$75 |
| 64MB..... | \$139 |
| 128MB..... | \$279 |
| iMac | |
| 16MB..... | \$65 |
| 32MB..... | \$75 |
| 64MB..... | \$139 |
| 128MB..... | \$279 |

Memory prices subject to change. Please call for current prices.

Sales & Customer Service
24 Hours a Day, 7 Days a Week..... (800) 260-8549

Inquiries & International Sales
M - F 5am - 9pm PST..... (949) 768-8130

24-Hour Fax..... (949) 768-9354

Corporate/Educational Sales
M - F 5am - 5pm PST..... (800) 258-2621

Technical Support
M - F 5am - 9pm PST..... (800) 854-6227

E-Mail: ClubMac Sales..... cmsales@clubmac.com
Customer Service..... custsvc@clubmac.com
Technical Support..... techsup@clubmac.com
Mail: ClubMac..... 7 Hammond, Irvine, CA 92618

Special Of The Month

Burn Baby Burn

Yamaha
2x/4x/6x
CDRW
Rerecordable
CDR Drive
Internal
CDR Media From \$1.25!



BOTTOM LINE
DISTRIBUTION



The one source for all your Macintosh needs.
Order from our secure server online at:
<http://www.blol.com/> Mac On! **1-800-990-5695**

Get More RAM!

DIMMs 168-Pin 5.0/5.5 volt
PCI PowerMac, UMAX, PowerPC
16MB 168-Pin DIMM 60ns .\$.49
32MB 168-Pin DIMM 60ns .\$.89
64MB 168-Pin DIMM 60ns .\$.129
PowerLogix 1MB Cache .\$.139
1MB VRAM DIMM .\$.26
Apple G3 RAM SDRAM
Exclusively for the new G3 Macs
32MB 100Mhz SDRAM .\$.69
64MB 100Mhz SDRAM .\$.99
128MB 100Mhz SDRAM .\$.219
256MB 100Mhz SDRAM .\$.499
4MB VRAM Upgrade .\$.39
SIMMs 72-Pin
16MB SIMM 60ns .\$.59
32MB SIMM 60ns .\$.79
256k L2 Cache SIMM .\$.99
1MB L2 Cache 61/71/8100 .\$.149
DIMMs 168-Pin 3.3 volt
Starmax, Apple 6500, 4400
32MB 168-Pin DIMM 60ns .\$.89
64MB 168-Pin DIMM 60ns .\$.129
Cache for 20th/6500/Starmax
512k L2 Cache DIMM .\$.89
1MB L2 Cache DIMM .\$.179

All RAM sold by BottomLine comes with a hassle free lifetime warranty!

Media 100qx
Professional
Digital Video
Capture Card
\$1799
*Component System \$3698

RAILGUN **\$689**
from Bottomline
G3
275/1MB
Comes with 1MB backside
cache at a 1.5/1 ratio (183Mhz)
IN STOCK!

UMAX
It's A Great Time To Buy A Scanner!
Check out these after-rebate Prices!
UMAX 610s 300x600 .\$.95*
UMAX 1220U USB 600x1200 .\$.129*
UMAX 1220s 600/1200 .\$.187*
UMAX 1220s w/PhotoDLX .\$.229*
Microtek V310 300/600 .\$.58.99*
Microtek G3 USB .\$.49.99*
*After Mail-In Rebate
<http://www.blol.com/rebate/>

Norton
Utilities v4.0 **\$98.99**
Now Compatible With HFS+

Optiquest
Q71-2 17"
Monitor
\$269

iomega **\$339**
Iomega Jaz 2GB
External
Removable Drive
ClubMac.....\$379
MacMall.....\$399
OtherWorld.....\$449
Jaz 2GB
Carts
From
\$84.99

**OS 8.5
is Here**

The MUST Have
Upgrade!
Cybout.....\$99.95
MacMall.....\$88.99
MacZone.....\$89.99

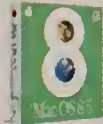

\$87.95
CD-ROM
PowerPC Only

HITACHI
Rasterops/Mac
26mm dot pitch
1152x870 Max
3-Year Warranty
Bottom Line's
Low Price
ClubMac.....\$495
MacMall.....\$489
Warehouse.....\$499
\$469

XLR8 G3 Processor
Card Upgrade
Fastest Upgrade
On The Planet!
In STOCK!
MacWarehouse.....\$1999
MacZone.....\$1899
ClubMac.....\$1799
Cyberian.....\$1899
\$1689

64MB
64MB 164-Pin DIMMs
Lifetime Warranty From Bottom Line
Bottom Line's
Low Price
MacMall.....\$209.99
MacZone.....\$157.98
Cyberian.....\$155.99
Club-Mac.....\$189.99
\$129.99

EPSON
1520 Tabloid
17"x22"
720x1440 dpi
Bottom Line's
Low Price
ClubMac.....\$499
MacMall.....\$499
MacWarehouse.....\$499
\$489

Nikon
Coolpix 900s
Megapixel
Digital Camera!
Bottom Line's
Low Price
ClubMac.....\$799
MacWarehouse.....\$799
MacZone.....\$749
\$745

128MB
128MB SDRAM DIMMs
For G3 Apple® PowerMac Systems
Lifetime Warranty From Bottom Line
Bottom Line's
Low Price
Cyberian.....\$239
MacMall.....\$279
MacZone.....\$364
ClubMac.....\$255
\$219

The Bottom Line iMac Store

Win A Free iMac!
The New
iMac From
Apple
Computer
\$1299
value
Register To Win A Free
iMac
on our web site
<http://www.blol.com/>

iMouse \$23.99
Superdisk \$154.99
Keyspan PCI \$79.99

Get More RAM!:
iMac 32MB Module\$69
iMac 64MB Module\$109
iMac 128MB Module\$239
iMac 2MB VRAM\$24
iMac 4MB VRAM\$39
USB Devices:
Agfa 1212U Scanner USB.....\$179.99
Macally iMouse\$23.99
Macally iHub 4-Port USB.....\$49.99
Macally iBall USB Trackball...\$49.99
Farallon iPrint LocalTalk\$109
Ethernet Crossover Cable.....\$10.99
Connectix Color QuickCan\$119
Epson 1220U USB Scanner.....\$179
Epson Color 640 USB Printer...\$199
Epson 740 USB Printer\$279
Parallel To USB Cable\$37.99
Keyspan PCI USB Card\$79.99
uConnect USB To Serial.....\$65.99

G3 Processor Card Upgrades

RAILGUN from Bottomline
RailGun G3 250/512k 2/1\$399
RailGun G3 275/1MB 2/1\$689
RailGun G3 300/150Mhz 1MB ..\$769
RailGun G3 300/300Mhz 1MB ..\$1199
POWERLOGIX
The "Little Screamer":
PowerForce G3 220/110Mhz 512k \$383
PowerForce G3 300/120Mhz 512k \$499
PowerForce G3 300/150Mhz 1MB \$789
New ZIF Upgrade For G3 Macs
PowerLogix G3 400Mhz 1MB\$1399
XLR8
XLR8 G3 300/200Mhz 1MB ..\$859.99
XLR8 G3 400/200Mhz 1MB \$1689.99

New Apple G3 System Pricing!

Desktop & Mini-Tower Systems
\$1899 G3 MT 300Mhz 64MB
RAM/8GB HD/Zip/24x/AV
DT 300Mhz 64/6GB/24x/Zip
\$1499 G3 MT 333/64/8GB/CD/AV ..\$2899
G3 MT 300 64/8/24x/Zip/AV \$2289
G3 DT 300 64/6GB/24x/Zip..\$1899
G3 DT 300/32/4GB/2xDVD ..\$1999
Need extra RAM/VRAM We Have it!

Your CDR/CDRW Recordable & ReRecordable Drive Headquarters

CDR For ALL!
Panasonic
CDR Media:
10-Pack \$13.99
25-Pack \$32.25
100-Pack..\$119
4x/8x Internal! Best Price!
External w/Toast and Cables \$339.99!!
Bottom Line's
Unbeatable
Low Price
\$229
Adaptec Toast 3.5x OEM \$69.99
CDR Media From\$1.19
Ricoh CDRW Media.....\$14.99

YAMAHA
CDR/CDRW
External Yamaha Brand:
ReRecordable 2x/4x/6x Tst ..\$479
ReRecordable 4x/4x/16x\$529
Yamaha Internal:
ReRecordable 2x/4x/6x.....\$299
ReRecordable 4x/4x/16x\$459
Princo CDRW Media\$11.99
85/9500 Internal CD-Kit ..\$23.97
86/9600/G3 Int. CD-Kit ..\$19.79

Digital Cameras

Nikon CoolPix 900s Camera ..\$745
Nikon CoolPix 600 Camera\$364
Olympus D600L Camera\$879
Olympus D220L w/LCD.....\$289
Agfa ePhoto 307 Camera\$239
Agfa ePhoto 780 w/LCD.....\$385
Agfa ePhoto 1280 w/LCD.....\$599
Kodak DC 260 Camera.....\$895
Kodak DC120 w/LCD\$559

Scanners

UMAX Astra 1220s 600dpi\$187*
UMAX PowerLook II\$1239.99
Microtek V310 300dpi\$49*
Microtek Scanmaker X6\$149.99
Microtek Scanmaker 4 36-bit ..\$689
Agfa Snapscan 1236s\$239.99
Agfa Duoscan T-1200\$659.99
Agfa Arcus II *Solo*.....\$1199
Agfa Duoscan Dual-Mode.....\$2499

Fast 7200/10,000rpm Hard Drives

SCSI Drives:
Seagate Medalist 4.55GB\$289
Seagate Medalist 9.1GB\$489
Seagate Barracuda 9.1GB\$695
Seagate Barracuda 18.2GB...\$1285
Seagate Cheetah LVD 9.1GB ..\$729
IBM Ultrastar 9ES 4.55GB\$339
IBM Ultrastar 9ES 9.1GB\$599
Quantum Atlas III 9.1GB.....\$539

IDE Drives:
MAXTOR 10.2GB EIDE\$339
MAXTOR 7.5GB EIDE\$269
SCSI Cards:
Jackhammer Fast/Wide\$289
ATTO Express PCI Fast/Wide \$269
ATTO Ultra2 PCI LVD\$409
Initio w/Conley RAID Softwr\$189
Initio Ultra2 SCSI w/RAID\$379

New Apple G3 PowerBooks Are Here!

Select the best PowerBook for you!
From:
\$1989
233Mhz 2GB/32/20x/12.1"\$1939
233Mhz 2GB/32/20x/56k/12.1"\$2079
233Mhz 32/2GB/20x/14.1"\$2369
233Mhz/512k 32/2GB/20x/14.1" ..\$2799
266Mhz 64/4GB/20x/14.1"\$3299
300Mhz 64/8GB/DVD/14.1"\$4899
"New" G3 PowerBook RAM:
16MB Memory Module\$79.99
32MB Memory Module\$99.99
64MB Memory Module\$121.99
128MB Memory Module\$219.99

<http://www.blol.com/> **BOTTOM LINE** 1-800-990-5695 M-F 9-8 Sat. 10-4

Free UPS ground shipping on domestic orders over \$100.00, and under 10lbs.
Shipping: \$5, 5 lbs., UPS Ground Payment: No credit card surcharge. Corporate POs welcome. Tax: Texas residents add 8.25% sales tax. Prices: Items, prices and availability subject to change. Returns: Call for RMA number. Must be in original condition, opened software is non-refundable. All orders subject to a minimum 15% restocking fee. Original shipping is non-refundable. Apple brand products are not returnable for credit. Bottom Line Distribution cannot be responsible for errors in typography or photography. Apple specs subject to change. Customer Service: 512-485-4602. International Sales: Bottom Line Distribution is committed to the needs of international Macintosh users. We offer

Bottom Line Offers Business Leasing on all items we carry (orders over \$1000.00). Call today for details, or fill out a lease form online!

Choose 221 at www.macworld.com/getinfo

Free UPS Ground Shipping When You Order On-Line. Surf to: <http://www.blol.com/>

MEMORY MADNESS FROM THE LLB COMPANY

POWERBOOK MEMORY

| WALL STREET | |
|-------------|-------|
| 128MB | \$231 |
| 64MB | \$118 |
| 32MB | \$60 |
| 16MB | \$51 |

POWERBOOK G3

| | |
|-------|-------|
| 128MB | \$235 |
| 64MB | \$160 |
| 32MB | \$94 |
| 16MB | \$70 |

PB 3400 SERIES

| | |
|-------|-------|
| 128MB | \$235 |
| 96MB | \$190 |
| 64MB | \$128 |
| 32MB | \$68 |

PB 2400 SERIES

| | |
|------|-------|
| 64MB | \$125 |
| 32MB | \$95 |
| 24MB | \$80 |
| 16MB | \$75 |

PB 2300 SERIES

| | |
|------|-------|
| 48MB | \$152 |
| 36MB | \$139 |
| 32MB | \$118 |
| 20MB | \$112 |

PB 500 SERIES

| | |
|------|------|
| 32MB | \$86 |
| 16MB | \$49 |
| 8MB | \$45 |
| 4MB | \$40 |

PB1400 SERIES

| | |
|------|-------|
| 48MB | \$139 |
| 24MB | \$75 |
| 16MB | \$59 |
| 8MB | \$49 |

PB DUO SERIES

| | |
|------|-------|
| 36MB | \$212 |
| 28MB | \$115 |
| 20MB | \$98 |
| 14MB | \$85 |

PB 5300 SERIES

| | |
|------|-------|
| 48MB | \$120 |
| 32MB | \$93 |
| 16MB | \$60 |
| 8MB | \$51 |



MEMORIZE YOUR MAC

| 32MB SIMMS 72-PIN SIMMS | 4MB SIMMS 30-PIN SIMMS |
|----------------------------|---------------------------|
| 32MB \$79 | 16MB \$52 |
| 16MB \$37 | 4MB \$14 |
| 8MB \$24 | 2MB \$10 |

| DIMMS | \$189 | \$69 | \$144 | \$140 |
|----------------------------|-----------------------------|-----------------------------|------------------------------|-------|
| 128MB DIMMS POWERMAC G3 | 32MB DIMMS 168-PIN DIMMS | 64MB DIMMS 5 V EDO DIMMS | 64MB DIMMS 3.3V EDO DIMMS | |
| 128MB \$189 | 128MB \$350 | 64MB \$144 | 64MB \$140 | |
| 64MB \$96 | 64MB \$144 | 32MB \$72 | 32MB \$67 | |
| 32MB \$43 | 32MB \$69 | 16MB \$40 | 16MB \$41 | |

Electronic Orders: E-Mail: sales@llb.com •
Web Site: www.llb.com •
• Open 6am to 7pm M-F, 8am to 1pm Sat. PST
• All major credit cards accepted and charged
when order is shipped
• No surcharge on credit cards
• Orders received before 8:00p.m. EST
weekdays shipped same day
• PO's are accepted upon approval
• Returns subject to restocking fee
• Prices subject to change, not responsible
for errors
• We welcome International orders
Mail PO's to:
2513 152nd Avenue N.E.,
Redmond, WA 98052

MONITORS



ViewSonic
\$566

| SONY | |
|-----------------|--------|
| CPD 100ES 15" | \$238 |
| CPD 200GS 17" | \$517 |
| CPD 520GS 21" | \$1127 |
| ViewSonic | |
| VS E655 15" | \$225 |
| VS GS771 17" | \$389 |
| VS G773 17" | \$398 |
| VS G800 20" | \$1032 |
| NEC | |
| NEC LCD2000 20" | \$6178 |
| NEC M500 15" | \$302 |
| NEC E500 15" | \$288 |
| NEC M700 17" | \$598 |

newer Add G3 Power with the NEW Maxpower & Nupower Series For the PowerMac G3 Series

| | |
|---|--------|
| Maxpower G3 210MHz/512K Cache | \$496 |
| Maxpower G3 240MHz/1MB Cache | \$680 |
| NEW For the PowerMac 75/8500 Series Etc | |
| Maxpower G3 333MHz/1MB Cache | \$1242 |
| Maxpower G3 400MHz/1MB Cache | \$2093 |
| NEW For the PowerMac 75/8500 Series Etc | |
| Maxpower G3 333MHz/1MB Cache | \$1242 |
| Maxpower G3 366MHz/1MB Cache | \$1489 |
| Maxpower G3 333MHz/1MB Cache | \$1984 |

MEDIA

VERBATIM

| | |
|----------------------------------|--------|
| 230MB 3.5" color MO disks-3-pk | \$31 |
| 1.2GB/512 b/s 5.25" MO disk | \$42 |
| 1.3GB/1024 b/s 5.25" MO disk | \$42 |
| 2.3GB/512 b/s 5.25" r/w MO disk | \$59 |
| 2.6GB/1024 b/s 5.25" r/w MO disk | \$59 |
| 4mm 60meter/1.3GB DL cartridge | \$5.99 |
| 4mm 90meter/2GB DL cartridge | \$6.50 |

SONY

| | |
|-----------------------------------|------|
| CDR 650MB 74min disks - 10-pack | \$21 |
| 128MB 3.5" optical disks - 3-pack | \$25 |
| 230MB 3.5" optical disks - 3-pack | \$38 |
| 600MB/512 b/s 5.25" optical disk | \$39 |
| 1.2GB/512 b/s 5.25" optical disk | \$39 |
| DDS 4mm 2GB Data cartridge | \$8 |
| DDS 4mm 4GB Data cartridge | \$16 |

POWER MACINTOSH
G3 Desktop 266MHz
PowerPC G3
32MB RAM
4GB HD
24X CD-ROM



\$1599

| POWER MACINTOSH G3 | |
|--|--------|
| iMAC 233 32/4GB/24X CD-ROM/56k Modem | \$1299 |
| G3/300 Desktop 64/6GB/24X CD-ROM | \$1999 |
| G3/300 Desktop 32/4GB/24X CD-ROM | \$1599 |
| G3/300 Mini-Tower 64/8GB/24X CD-ROM/6MB SGRAM | \$2399 |
| G3/333 Mini-Tower 128/9GB/24X CD-ROM/6MB SGRAM | \$2986 |



POWERBOOK G3/233
32/2GB/12.1 DSCAN
20X CD-ROM/ENET

\$1999

MACINTOSH G3
POWERBOOKS
WALL STREET

| | |
|--|--------|
| G3/233 32/2GB/12.1 DSCAN/20X CD-ROM/ENET | \$1999 |
| G3/233 32/2GB/12.1 DSCAN/20X CD-ROM/ENET/56K | \$2579 |
| G3/266 32/4GB/14.1 TFT/20X CD-ROMS VIDEO/ENET | \$3499 |
| G3/300 64/8GB/14.1 TFT/20X CD-ROM/ENET/S VIDEO | \$4935 |

Store with confidence!

| LACIE | |
|------------------------|-------|
| Q 2.1GB (Ext) 5400RPM | \$294 |
| Q 4.3GB (Ext) 5400RPM | \$360 |
| Q 9.0GB (Ext) 7200 RPM | \$686 |
| 36X Ext CD-Rom Drive | \$156 |
| 4X/8X CD-R w/Toast | \$484 |

iMAC MEMORY AS LOW AS \$1.77 PER MB

IOMEGA Jaz2 Ext. Drive
+ 1 Free Disk



| | |
|-----------------------|--------|
| Zip Drive w/Disk | \$119 |
| Zip Plus w/Disk | \$199 |
| ZIP 100 disk | \$9 |
| ZIP 100 disks -3-pk | \$27 |
| ZIP 100 disks -10-pk | \$89 |
| Jaz 1GB 3.5" disk | \$89 |
| Jaz 1GB disks - 5-pk | \$418 |
| Jaz 1GB disks - 20-pk | \$1641 |

PRINTERS & SCANNERS



| | |
|-------------------------|-------|
| Astra 610s | \$115 |
| Astra 1200 32Bit 600dpi | \$245 |
| Trans. Adptr Astra 1200 | \$198 |
| Trans. Adptr Astra 1220 | \$180 |

| HEWLETT PACKARD | |
|---------------------|--------|
| Laserjet 4000 17PPM | \$1139 |
| Laserjet 8000 24PPM | \$2463 |



| EPSON | |
|------------------------|--------|
| Stylus 800 Inkjet | \$247 |
| Stylus 700 Photo | \$259 |
| Expression 636 Artist. | \$699 |
| Expression 836 XL | \$2369 |
| Stylus Color 1520 | \$499 |
| Stylus Color 3000 | \$1279 |
| Stylus Photo EX | \$499 |

The LLB Company, Inc. 1-800-848-8967

www.llb.com International:425.881.1880 Fax:425.881.1930

Choose 220 at www.macworld.com/getinfo



APS HIGH-PERFORMANCE ULTRA SCSI DRIVES

| Model | Description | EL | Internal | Pro |
|-------------|--|---------------------|---------------------|---------------------|
| APS Q 2000 | Quantum Fireball ST, 2079MB, 5400 rpm | \$209 ⁹⁵ | \$219 ⁹⁵ | \$279 ⁹⁵ |
| APS Q 3000 | Quantum Fireball ST, 3118MB, 5400 rpm | 229 ⁹⁵ | 239 ⁹⁵ | 299 ⁹⁵ |
| APS Q 4000 | Quantum Fireball ST, 4110MB, 5400 rpm | 269 ⁹⁵ | 279 ⁹⁵ | 339 ⁹⁵ |
| APS ST 4000 | Seagate Medalist Pro, 4340MB, 7200 rpm | 289 ⁹⁵ | 299 ⁹⁵ | 379 ⁹⁵ |
| APS I 4500 | IBM Ultrastar, 4357MB, 7200 rpm | 299 ⁹⁵ | 309 ⁹⁵ | 389 ⁹⁵ |
| APS ST 6000 | Seagate Medalist Pro, 6348MB, 7200 rpm | 389 ⁹⁵ | 399 ⁹⁵ | 419 ⁹⁵ |
| APS Q 6400 | Quantum Fireball ST, 6236MB, 5400 rpm | 359 ⁹⁵ | 369 ⁹⁵ | 419 ⁹⁵ |
| APS Q 8000 | Quantum Fireball ST, 8191MB, 5400 rpm | 459 ⁹⁵ | 469 ⁹⁵ | 529 ⁹⁵ |
| APS I 9000 | IBM Ultrastar 9ES, 8705GB, 7200 rpm | 549 ⁹⁵ | 559 ⁹⁵ | 639 ⁹⁵ |
| APS ST 9000 | Seagate Medalist Pro, 8683MB, 7200 rpm | 499 ⁹⁵ | 509 ⁹⁵ | 599 ⁹⁵ |
| APS I 18000 | IBM Ultrastar 18XP, 17501GB, 7200 rpm | 999 ⁹⁵ | 1,009 ⁹⁵ | 1,099 ⁹⁵ |

HIGH-PERFORMANCE ULTRA WIDE SCSI DRIVES

| Model | Description | EL | Internal | Pro |
|---------------|--|---------------------|---------------------|---------------------|
| APS ST 4000 W | Seagate Medalist Pro, 4340MB, 7200 rpm | \$299 ⁹⁵ | \$309 ⁹⁵ | \$389 ⁹⁵ |
| APS Q 4300 W | Quantum Fireball ST, 4240MB, 7200 rpm | 309 ⁹⁵ | 319 ⁹⁵ | 389 ⁹⁵ |
| APS I 4500 W | IBM Ultrastar 9ES, 8715GB, 7200 rpm | 299 ⁹⁵ | 309 ⁹⁵ | 389 ⁹⁵ |
| APS ST 6000 W | Seagate Medalist Pro, 6348MB, 7200 rpm | 389 ⁹⁵ | 399 ⁹⁵ | 479 ⁹⁵ |
| APS I 9000 W | IBM Ultrastar 9ES, 8715GB, 7200 rpm | 549 ⁹⁵ | 559 ⁹⁵ | 639 ⁹⁵ |
| APS ST 9000 W | Seagate Barracuda, 8683MB, 7200 rpm | 589 ⁹⁵ | 599 ⁹⁵ | 679 ⁹⁵ |
| APS I 9100 W | IBM Ultrastar 9ZX, 8705GB, 10,000 rpm | 649 ⁹⁵ | 659 ⁹⁵ | 739 ⁹⁵ |
| APS I 18000 W | IBM Ultrastar 18XP, 17501GB, 7200 rpm | 999 ⁹⁵ | 1,009 ⁹⁵ | 1,099 ⁹⁵ |
| APS Q 18000 W | Quantum Fireball ST, 17366MB, 7200 rpm | 1,059 ⁹⁵ | 1,069 ⁹⁵ | 1,099 ⁹⁵ |

HIGH-PERFORMANCE ULTRA2 WIDE SCSI DRIVES

| Model | Description | Internal | Pro |
|------------------|--------------------------------------|---------------------|---------------------|
| APS Q 4300 U2W | Quantum Viking II, 4240MB, 7200 rpm | \$319 ⁹⁵ | \$399 ⁹⁵ |
| APS Q 9000 U2W | Quantum Viking II, 8682MB, 7200 rpm | 599 ⁹⁵ | 699 ⁹⁵ |
| APS ST 9000 U2W | Seagate Barracuda, 8683MB, 7200 rpm | 659 ⁹⁵ | 729 ⁹⁵ |
| APS ST 9100 U2W | Seagate Cheetah, 8842MB, 10,000 rpm | 779 ⁹⁵ | 849 ⁹⁵ |
| APS ST 18000 U2W | Seagate Cheetah, 18200MB, 10,000 rpm | 1,289 ⁹⁵ | 1,359 ⁹⁵ |

APS IDE DRIVES

| Model | Description | Internal |
|---------------|-------------|---------------------|
| APS 3000 ATA | 5400 rpm | \$129 ⁹⁵ |
| APS 4000 ATA | 5400 rpm | 159 ⁹⁵ |
| APS 6000 ATA | 5400 rpm | 199 ⁹⁵ |
| APS 10000 ATA | 5400 rpm | 249 ⁹⁵ |
| APS 12000 ATA | 5400 rpm | 289 ⁹⁵ |

APS REMOVABLE DRIVES

| Model | Description | EKO | SR 2000 | Pro |
|------------|--|---------------------|---------|---------------------|
| APS Jaz II | 2GB (with 1 cartridge) | N/A | N/A | \$399 ⁹⁵ |
| Jaz II EKO | 2GB in EKO case (cartridge not included) | \$299 ⁹⁵ | N/A | N/A |

APS MO DRIVES

| Model | Description | Internal | Pro |
|--------------|----------------------|-----------------------|---------------------|
| APS 640 MO | Fujitsu M2513A23N | N/A | \$349 ⁹⁵ |
| APS 5.2GB MO | Sony SMD-F551, 5.2GB | \$1,769 ⁹⁵ | 1,849 ⁹⁵ |

APS CD-ROM/CD-R/CD-RW DRIVES & MASTERING SYSTEMS

| Model | Description | External |
|-----------------------|--|---------------------|
| APS CD36 | 36X CD in Slimline Case | \$149 ⁹⁵ |
| APS CD Changer | Nakamichi 5 Disc/16X CD-RDM, Pro Case only | 259 ⁹⁵ |
| APS CD-R 4X8P | 4X record/8X read CD-R in Pro Enclosure | 379 ⁹⁵ |
| APS CD-RW | 2X record/2X rewrite/6X read CD-RW in Pro Enclosure | 399 ⁹⁵ |
| APS CD-RW Pro | 4X record/4X rewrite/16X read CD-RW, Pro Enclosure | 599 ⁹⁵ |
| APS Jaz II/CD-RW Sys. | Jaz 2GB & 4X record/4X rewrite/16X read CD-RW, Full Height Encl. | 979 ⁹⁵ |

APS TAPE BACKUP SYSTEMS

| Model | Description | Internal | External |
|-------------------|----------------------------|---------------------|---------------------|
| APS HyperDAT® | DDS-2DC, 8GB | \$549 ⁹⁵ | \$599 ⁹⁵ |
| APS HyperDAT® Pro | DDS-2DC, 8GB | 749 ⁹⁵ | 799 ⁹⁵ |
| APS HyperDAT® III | DDS-3DC, 24GB | 999 ⁹⁵ | 1,079 ⁹⁵ |
| APS Mini Library | 4mm DDS-2 AutoLoader, 64GB | N/A | 2,399 ⁹⁵ |
| APS DLT40 | DLT 4000, 40GB | N/A | 2,679 ⁹⁵ |
| APS DLT70 | DLT 7000, 70GB | N/A | 5,999 ⁹⁵ |
| APS AIT* | 8mm WJ/DC, 50GB | N/A | 2,399 ⁹⁵ |

*See our Adapter Power/Disk 2940 Ultra Wide SCSI Host Adapter offer to gain maximum throughput. Call for information about Windows 95 and Windows NT versions of these great drive products.

Order online @ <http://www.apstech.com/mwspecial/>

Fastest rewritable CD ever

APSCD-RW 4X4X16

- 4X record/4X rewrite/16X read Yamaha mechanism
- APS' fastest CD-RW drive ever
- Includes complete Mac/Windows CD recording software



Now, you can rewrite CD-RW media twice as fast as before. The brand-new APS CD-RW 4X4X16 also reads CDs 133% faster than its predecessor. And in the APS Pro case, the Yamaha mechanism is protected from overheating by a huge fan and patented IC²E technology. For the best CD-RW performance around, order the APS CD-RW 4X4X16 now.

\$599⁹⁵
APS Pro enclosure

APSCD-R 8X20 \$649⁹⁵

- You-gotta-be-kidding-me fast CD burner
- Sanyo mechanism
- Includes complete Mac/PC software

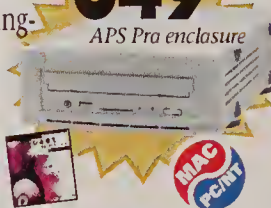

APS I 4500 W \$299⁹⁵

- 7200 rpm IBM Ultrastar ES with 4.5GB
- Top price/performance for graphics workstation
- Ultra Wide SCSI-3

APSHYPERQIC® \$349⁹⁵

- The standard in desktop/workstation backup
- Safeguard up to 8GB on one tape
- Travan-4/QIC w/ HDC

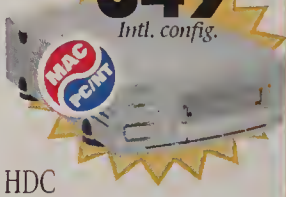

\$149⁹⁵ APS CD 36

- Fastest CD-ROM drive ever from APS
- No dropped frames or stuttering audio
- Multimedia marvel

*Does not include DA-Term, but does come with block terminator



\$999⁹⁵ APS I 18000 W

- Outstanding file, Web and app server storage
- 7200 rpm with 18GB
- Ultra Wide SCSI

Shown in APS Pro enclosure

APSHYPERDAT® III

- 12GB native, 60MB/min. transfers
- Ideal for home office workstation/small network backup

APSJAZ II/CD-R 4X12 MASTERING SYSTEM

- Pre-master your discs on Jaz



Corporate Sales (800) 554-3941 International (816) 920-4109

APS Technologies • 6131 Deramus • Kansas City, MO 64120

Order from Our Special Online Catalog @

<http://www.apstech.com/mwspecial/>

Check order status @ <http://www.apstech.com/status.html>

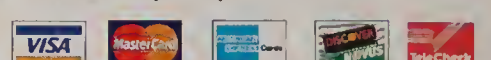

Call 800-285-0638 Today

Mac OS is a registered trademark of Apple Computer, Inc. APS and APS Technologies are registered trademarks. Other brand or product names are registered trademarks or trademarks of their respective holders.

- 30-day money-back satisfaction on all APS brand drives and accessories. Your risk is the cost of shipping. Monitors and 3rd party products carry warranties from their respective manufacturers.
- SCSI cables sold separately.
- APS' warranty is a pass-through of the mechanism manufacturer's warranty which will be serviced by APS for one year. APS warrants APS branded enclosures, brackets and power supplies for a period of one year from the date of purchase and will, at its discretion, replace or repair products found to be defective according to the specific terms of the warranty accompanying the product.
- Refused orders subject to 20% restocking fee.
- International customers must pay for all shipping charges.
- Listed capacities are formatted.
- Actual data compression and tape capacity vary greatly depending on the type of data recorded, other system parameters and environment.
- Prices and specifications are subject to change without notice.
- You must install system software appropriate to your machine before using our hard drives.
- Not responsible for typographical errors.
- Your APS Drive unit may contain one or more components that were in prior use, but which have been inspected and repaired or rebuilt as necessary. These components, if any are covered by the same warranty provisions, exclusions and limitations to the same extent, and on the same terms as otherwise "new" components.
- © 1998, APS Technologies. All Rights Reserved.



Order from Our Special Online Catalog @ <http://www.apstech.com/mwspecial/>

ULTRA SCSI

| | | | | | Int | Ext |
|---------|---------|-------|-----------|-----|-------|-------|
| 2111MB | 5400rpm | 512K | FB32100S | 3yr | \$205 | \$265 |
| 3228MB | 5400rpm | 512K | FB33200S | 3yr | \$235 | \$295 |
| 4310MB | 5400rpm | 512K | FB34300S | 3yr | \$269 | \$329 |
| 6448MB | 5400rpm | 512K | FB36400S | 3yr | \$350 | \$410 |
| 8455MB | 5400rpm | 512K | FB38400S | 3yr | \$429 | \$489 |
| 9100MB | 7200rpm | 1024K | XP309100S | 5yr | \$519 | \$579 |
| 18200MB | 7200rpm | 1024K | XP318200S | 5yr | \$959 | \$999 |

ULTRA WIDE SCSI

| | | | | | | |
|--------|---------|------|-----------|-----|-------|-------|
| 4550MB | 7200rpm | 512K | VK304550W | 5yr | \$289 | \$379 |
| 9100MB | 7200rpm | 512K | VK309100W | 5yr | \$459 | \$549 |

ULTRA 2 SCSI

| | | | | | | |
|---------|---------|-------|------------|-----|-------|-------|
| 4550MB | 7200rpm | 512K | VK304550LW | 5yr | \$289 | \$389 |
| 9100MB | 7200rpm | 512K | VK309100LW | 5yr | \$459 | \$559 |
| 9100MB | 7200rpm | 1024K | XP309100LW | 5yr | \$519 | \$619 |
| 18200MB | 7200rpm | 1024K | XP318200LW | 5yr | \$959 | \$999 |

MegaHaus is the first company to sell the new Quantum Approved Audio Visual drives specifically tuned to meet demanding A/V applications.

ULTRA 2 SCSI A/V (Minimum sustained 10MB/sec)

| | | | | | | |
|---------|---------|-------|-------------|-----|-------|--------|
| 4550MB | 7200rpm | 512K | VK304550LV4 | 5yr | \$319 | \$419 |
| 9100MB | 7200rpm | 512K | VK309100LV4 | 5yr | \$489 | \$589 |
| 18200MB | 7200rpm | 1024K | XP318200LV4 | 5yr | \$989 | \$1079 |

We are the #1 source for Quantum

Capacity for the Extraordinary



• CD RECORDERS •

Smart Storage Solutions CDR Drives Include:
 ✓ Toast Mastering Software
 ✓ 5 FREE disks
 ✓ Toll Free support

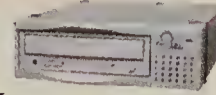

Includes Toast & DirectCD Software!
 DirectCD from Adaptec now makes a CD Recorder as easy to use as a hard drive.

4x8 CDR \$259

Smart STORAGE SOLUTIONS

Compare our price and you will see we are the #1 source for CD Recorders!

CD RECORDABLE Includes 5 Free Recordable Disks!

| | Internal | External |
|---|----------|----------|
| 4x8 Panasonic mechanism, tray load, 1MB buffer | \$259 | \$319 |
| 4x12 Teac mechanism, tray load, 1MB buffer | \$329 | \$389 |
| 4x12 Plextor mechanism, caddy/tray load, 2MB buffer | \$389 | \$449 |
| 8x20 tray load, 2MB buffer | \$589 | \$639 |

PRICE BREAKTHRU CD REWRITABLE Includes 5 Free ReWritable Disks!

| | | |
|--|-------|-------|
| 4x4x16 Yamaha mechanism, tray load, 2MB buffer | \$389 | \$449 |
| Special external with only 1 CD-RW disk (SSS4X4X16M1) | | \$429 |
| CD-RW starter pack 5 CD-RW disks & 10 CD-R disks (CDSTARTER) | | \$60 |

Stomper CD label kit only \$39 with CD-R drive!

| | | | | | |
|----------------------------------|--------------------------------|---------------------------|---------------------------|--------------------------|------------------------|
| Fargo Signature CD Printer \$999 | CD Duplicators Call for price. | CD Stomper label kit \$49 | Toast retail package \$89 | 100 CDR-74 w/drive \$120 | 50 CD-RW w/drive \$499 |
|----------------------------------|--------------------------------|---------------------------|---------------------------|--------------------------|------------------------|

Duo Master is one of the most innovative CD mastering solutions available. The solution provides a hard drive, Jaz or Syjet drive and CDR in one unit. Create your master on the hard drive, Jaz or Syjet cartridge drive and then master directly to the CD. This is the perfect CD mastering setup! Includes 5 free recordable CDs (5 CD-RWs with CD-RW drives) and 1 free cartridge with Jaz or Syjet unit. Add these prices to the internal prices above.

Quantum 2GB (DUO2GBM) \$270 Quantum 4GB (DUO4GBM) \$340
 Syjet 1.5GB (DUOSYJTM) \$319 Jaz 2GB (DUO2GBJAZM) \$399

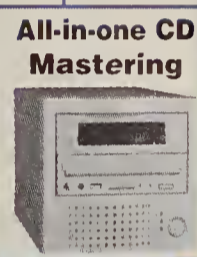

DLT TAPE The professional's choice for backup. We will not be undersold on Quantum DLT Tape drives!

| Native | Compressed | Internal | Table Top | Rack Mount |
|--------|------------|----------------|---------------------|---------------------|
| 20GB | 40GB | \$2300 DLT4000 | \$2575 DLT4000QX | n/a |
| 35GB | 70GB | \$5350 DLT7000 | \$5625 DLT7000QX | n/a |
| 100GB | 200GB | n/a | \$3879 DLT4500 | \$3769 DLT4500R |
| 140GB | 280GB | n/a | \$5589 DLT4700 | \$5389 DLT4700R |
| 280GB | 560GB | n/a | \$10,499 DLT4114LST | \$10,199 DLT4114LSR |
| 490GB | 980GB | n/a | \$13,999 DLT7114ST | \$13,699 DLT7114SR |

Call for Differential SCSI models, and DLTstor products. Call for the best prices in the industry on DLT media.

• SCSI HARD DRIVES •

Seagate

| | | | | | Internal | External |
|---------|---------|-------|-----------|-----|----------|----------|
| 4520MB | 7200rpm | 512K | ST34520N | 3yr | \$239 | \$299 |
| 4550MB | 7200rpm | 512K | ST34573N | 5yr | \$439 | \$499 |
| 6530MB | 7200rpm | 512K | ST36530N | 3yr | \$345 | \$405 |
| 9140MB | 7200rpm | 512K | ST39140N | 3yr | \$459 | \$519 |
| 9190MB | 7200rpm | 1024K | ST39173N | 5yr | \$495 | \$555 |
| 18200MB | 7200rpm | 1024K | ST118273N | 5yr | \$979 | \$1039 |

ULTRA WIDE SCSI

| | | | | | | |
|---------|---------|-------|-----------|-----|-------|--------|
| 4520MB | 7200rpm | 512K | ST34520W | 3yr | \$249 | \$339 |
| 4550MB | 7200rpm | 512K | ST34573W | 5yr | \$439 | \$529 |
| 6530MB | 7200rpm | 512K | ST36530W | 3yr | \$345 | \$435 |
| 9140MB | 7200rpm | 512K | ST39140W | 3yr | \$459 | \$549 |
| 9190MB | 7200rpm | 1024K | ST39173W | 5yr | \$489 | \$579 |
| 18200MB | 7200rpm | 1024K | ST118273W | 5yr | \$979 | \$1069 |

ULTRA 2 SCSI

| | | | | | | |
|---------|-----------|-------|-------------|-----|--------|--------|
| 4550MB | 7200rpm | 1024K | ST34573LW | 5yr | \$465 | \$575 |
| 4550MB | 10,000rpm | 1024K | ST34502LW | 5yr | \$520 | \$630 |
| 9100MB | 10,000rpm | 1024K | ST39102LW | 5yr | \$690 | \$800 |
| 9100MB | 10,000rpm | 4096K | ST39102LW4 | 5yr | \$779 | \$889 |
| 9190MB | 10,000rpm | 1024K | ST39173LW | 5yr | \$529 | \$639 |
| 18200MB | 7200rpm | 1024K | ST118273LW | 5yr | \$989 | \$1099 |
| 18200MB | 10,000rpm | 1024K | ST118202LW | 5yr | \$1289 | \$1399 |
| 18200MB | 10,000rpm | 4096K | ST118202LW4 | 5yr | \$1399 | \$1509 |

IBM

| | | | | | | |
|---------|---------|------|-----------|-----|-------|--------|
| 4550MB | 5400rpm | 512K | IBM34560N | 5yr | \$275 | \$335 |
| 9100MB | 7200rpm | 512K | IBM39130N | 5yr | \$500 | \$560 |
| 18200MB | 7200rpm | 1MB | IDGHS18Z | 5yr | \$959 | \$1019 |

ULTRA WIDE SCSI

| | | | | | | |
|---------|----------|------|-----------|-----|-------|--------|
| 4550MB | 5400rpm | 512K | IBM34560W | 5yr | \$275 | \$365 |
| 9100MB | 7200rpm | 512K | IBM39130W | 5yr | \$500 | \$590 |
| 9100MB | 10020rpm | 1MB | IDVGS9U | 5yr | \$579 | \$669 |
| 18200MB | 7200rpm | 1MB | IDGHS18U | 5yr | \$969 | \$1059 |

ULTRA-2 SCSI

| | | | | | | |
|---------|---------|------|------------|-----|--------|--------|
| 9100MB | 7200rpm | 512K | IBM39130U2 | 5yr | \$505 | \$615 |
| 18200MB | 7200rpm | 1MB | IDGHS18U2 | 5yr | \$1019 | \$1129 |

New SCA Drive Enclosure - Perfect for RAID

- Holds three 1" high SCA drives.
- Drive modules are hot swappable.
- Heavy duty construction and cooling.

| | |
|------------------------------------|--------|
| Enclosure with modules (SCA3CASE) | \$329 |
| With 3 9GB Quantum Viking Ultra-2 | \$1699 |
| With 3 9GB Seagate Cheetah Ultra-2 | \$2399 |

• CD ROM DRIVES •

| | | | Internal | External |
|----------------------|-----------|-------------|----------|----------|
| 16X - 5 disc changer | Nakamichi | MJS16M/XM | \$189 | \$249 |
| 24X - 6 disc changer | Pioneer | DRM6324XM | \$419 | \$419 |
| 32X - Tray load | Toshiba | XM6201BM/XM | \$105 | \$165 |
| 32X - 512K buffer | Plextor | PX32TSM/XM | \$145 | \$205 |
| 36X - Slot load | Pioneer | DRU706M/XM | \$90 | \$150 |

• MISCELLANEOUS •

IOMEGA 2GB Jaz

| | JAZ2X | Price |
|-------------------|-------|-------------|
| 1GB qty 2-9 / 10+ | | \$79 / \$77 |
| 2GB qty 2-9 / 10+ | | \$87 / \$85 |

Ask about rebate SYJET1.5MAC \$275

ADAPTEC Controllers

| Model | Price |
|--------------------------|-----------------|
| PCI Wide Single Channel | A2940MUW \$259 |
| PCI Wide Dual Channel | A3940MUW \$439 |
| PCI FireWire + Wide SCSI | AHA8945 \$559 |
| PCI Ultra 2 | A2940MU2W \$399 |

ATTO Controllers

| Model | Price |
|--------------------------------|------------------|
| PCI Fibre Channel | ATTOPCIFC \$769 |
| PCI Ultra 2 SCSI | ATTOPCIU2 \$425 |
| above w/ RAID software & cable | ATTOPCIU2K \$609 |

E4 Cool DVD Kit

| | |
|-----------------------------------|--------------|
| Complete kit for Mac G3 computers | DVDMAC \$349 |
|-----------------------------------|--------------|

Maxoptix Optical Drives

| | | | |
|------------------------------------|--------|------------------------------------|--------|
| 2.6GB T5-2600 | \$1149 | 5.2GB T6-5200 | \$1499 |
| 2.6GB media 2-4/5-9/10+ \$40/36/34 | | 5.2GB media 2-4/5-9/10+ \$95/91/89 | |

Sony Tape Drives with Retrospect

| | | | |
|--|-------|---------------------------------------|--|
| Turbo (up to 90MB/min) 4-8GB external kit SDT7000XM | \$699 | | |
| Turbo (up to 144MB/min) 12-24GB external kit SDT9000XM | \$929 | | |
| 120Meter Tapes 2-4/5-9/10+ \$17/14/12 | | 125Meter Tapes 2-4/5-9/10+ \$31/28/26 | |

CD-RW PRICE DROP! • CDR MEDIA •

Nobody beats MegaHaus for CD Recordable Media prices! We will not be undersold. If by chance you do find a lower price, call us.

| | CDR74 | CDR74W | CDR74P |
|-----------------|-------------|-------------|-------------|
| 5 Pack | \$21/\$19 | \$59/\$55 | \$28/\$25 |
| 20 Pack | \$42/\$39 | \$189/\$185 | \$65/\$62 |
| 50 Pack | \$93/\$89 | \$429/\$419 | \$139/\$135 |
| 100 Pack | \$159/\$149 | \$819/\$809 | \$259/\$249 |
| Budget 5 Pack | \$19/\$17 | \$33/\$33 | \$24/\$21 |
| Budget 20 Pack | \$36/\$33 | \$129/\$125 | \$55/\$52 |
| Budget 50 Pack | \$74/\$70 | \$319/\$309 | \$119/\$109 |
| Budget 100 Pack | \$139/\$120 | \$619/\$609 | \$189/\$179 |

CDR74 is recordable, CDR74W is rewritable, CDR74P is printable. It is alone with CDR purchase. 8X certified, & Platinum now available.

• IDE HARD DRIVES •

3.5" ULTRA IDE - Call for models not listed

| | | | | | |
|---------|---------|---------|-----------|-----|-------|
| 2564MB | Quantum | 5400rpm | FB302500A | 3yr | \$119 |
| 3221MB | Seagate | 5400rpm | ST33221A | 3yr | \$129 |
| 4311MB | WD | 5400rpm | AC24300 | 3yr | \$145 |
| 6448MB | WD | 5400rpm | AC36400 | 3yr | \$175 |
| 6530MB | Seagate | 7200rpm | ST36530A | 3yr | \$199 |
| 7696MB | Quantum | 5400rpm | FB307600A | 3yr | \$189 |
| 8606MB | Seagate | 5400rpm | ST38641A | 3yr | \$199 |
| 9140MB | Seagate | 7200rpm | ST39140A | 3yr | \$229 |
| 10100MB | IBM | 7200rpm | IBM10GXP | 3yr | \$270 |
| 12750MB | Quantum | 5400rpm | FB312700A | 3yr | \$280 |
| 14400MB | IBM | 7200rpm | IBM14GXP | 3yr | \$405 |
| 16800MB | IBM | 5400rpm | IBM16GP | 3yr | \$399 |

2.5" IDE for laptops - Call for the best price around

RAID

These preconfigured RAID0s can be run in RAID 0 or 1 mode. The capacity listed is for RAID 0 configuration. In RAID 0, the data is striped across a pair of drives. This is perfect for digital video such as Media 100, TrueVision, Avid, or other applications that require extremely high data transfer rates.

Includes - Ultra 2 LVD SCSI drives - Adaptec PCI Ultra-2 SCSI controller - Adaptec Remus Lite RAID software - Necessary cables

| Model | Price | Removable | Fixed |
|--|--------|-----------|-------|
| 18GB 7,200rpm 2 9.1GB Quantum Viking drives | \$1839 | \$1639 | |
| 18GB 7,200rpm 2 9.1GB Quantum Atlas drives | \$1959 | \$1759 | |
| 18GB 7,200rpm 2 9.1GB Seagate Barracuda drives | \$1969 | \$1769 | |
| 18GB 10,000rpm 2 9.1GB Seagate Cheetah drives | \$2289 | \$2089 | |
| 36GB 7,200rpm 2 18GB Quantum Atlas drives | \$2879 | \$2679 | |
| 36GB 7,200rpm 2 18GB Seagate Barracuda drives | \$2929 | \$2729 | |
| 36GB 10,000rpm 2 18GB Seagate Cheetah drives | \$3579 | \$3379 | |

NETWORK READY CD TOWER

Connects directly to your Ethernet network. Easy to install. Auto switches between 10 and 100Mbps networks. Also has built-in http support for easy connection to Internet. Includes 8 32X drives SSS32X8N \$1699

J&R COMPUTER WORLD



Authorized Reseller

One of America's Largest
Authorized Apple® Dealers



Authorized Reseller

Exclusively from J&R!

Apple® Macintosh® PowerBook® 1400cs with 166MHz PowerPC™ 603e processor and 11.3" Dual-Scan Color Display

- 16MB RAM •1.3GB hard drive •128K L2 cache memory
- 12x-speed CD-ROM drive •1.4MB Apple SuperDrive®
- NiMH long-life battery •Type III PCMCIA slot

\$1199.99

(APP M6274LL/A)....

Lowest Priced
PowerBook Ever!
(Limited Quantity)



Modems

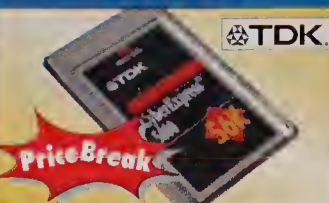

TDK CyberExpress 5600
56K V.90 PCMCIA Fax/Modem
for Macintosh/Windows
\$99.99 (TDK U6600012)

- U.S. Robotics External V.90 Modem (56K)
(USR EXTMAC56V90) **\$139.99**
- Global Village External V.90 Modem (56K)
(GLV EXT9056K) **\$149.99**
- Global Village PCMCIA V.90 Modem (56K)
(GLV 56KV90MAC) **\$169.99**

Scanners

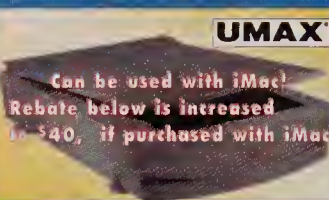

UMAX Astra 1220
36-Bit Color Scanner with USB
\$129.99 after \$20 mfr. rebate
(UMX AST1220UOU) exp. 12/31/98

- Nicrotek ScanMaker V310 (30-bit)
(MTK V310-MAC) **\$49.99**,
after \$30 mfr. rebate (exp. 12/31/98)
- UMAX Astro 1200S Duo Deluxe (30-bit)
(UMX AST1200DLX) **\$179.99**,
after \$50 mfr. rebate (exp. 12/31/98)
- Epson Expression 636 Executive (36-bit)
(EPS 636-EMAC) **\$799.99**

Networking

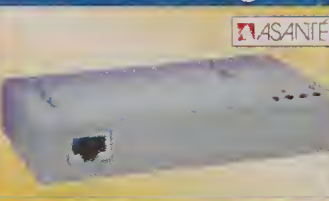

Asante AsanteTalk
Ethernet-to-LocalTalk Connection
for Apple iMac™
•Allows connection of LocalTalk printers
\$99.99 (ASA 99-00505-81)

- 3Com OfficeConnect Hub4
(3CM 3C16704) **\$48.99**
- 3Com OfficeConnect Hub8/TPO
•Connect up to 4 hubs on the 8th port
(3CM 3C16700) **\$79.99**

Mac Software

CyberStudio Personal Edition
by Golive
•Provides all the tools needed to design, layout, and manage effective websites
\$49.99
(GOA CYBERPE-C)

- AppleWorks (5.0) by Apple **\$89.99**
- Conflict Catcher 8 by Casady & Greene
\$74.99 (plus \$30 rebate for owners of previous versions, expires 1/1/99)
- FileMaker Pro (4.1) by FileMaker
\$184.99 (plus \$50 rebate for owners of qualifying products, expires 12/31/99)
- Mac OS 8.5 by Apple **\$89.99**
- Norton Utilities (4.0) by Symantec
\$89.99 (plus \$50 rebate for owners of previous versions)
- Office 98 by Microsoft **\$449.99**
- Virtual PC (2.1) with Windows 98 by Connectix **\$174.99**,
(plus \$30 rebate for owners of previous versions... expires 12/31/99)

Printers



EPSON Stylus® COLOR 600
Ink Jet Printer
•1440-dpi photo-quality color printing
and laser-quality block text •Refurbished
with a 2-year warranty from Epson
\$149.99 (EPS C20001-N)

EPSON USB Adapter Cable and Drivers
(dedicated adapter for connection of
Epson Stylus 600 and Apple iMac)
(EPS CUS8PK2) **\$49.99**

Data Storage



Iomega Jaz® 2GB
Portable External SCSI Drive
•2GB cartridges sold separately
\$349.99 (BER JAZEX2GIGNC)



SyQuest® syjet™
1.5GB External Hard Drive
•Comes with one 1.5GB cartridge
\$299.99 (SYQ SYJET15E-38)

Imation USB Drive



Imation SuperDisk™
USB Drive for the Apple iMac™
•Connects easily with iMac •Reads and
writes 120MB SuperDisk •Also reads
and writes standard high-density 3.5"
floppy diskettes (both Moc & PC formats)
•Sleek design complements iMac
\$169.99 (IMT 44002278065)

Imation SuperDisk Diskettes
(IMT 4402278420) **\$49.99 per 5-pk.**

Apple Monitors

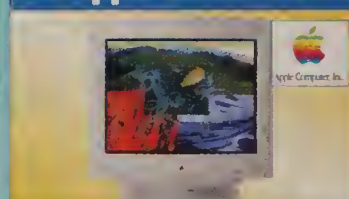

Apple® ColorSync® Display
17" Monitor (16.1" VIS)
•Sony Trinitron® CRT technology
\$699.99 (APP M6159LL/A)

Multiple Scan 720 17" Display (16" VIS)
(APP M6151LL/A) **\$499.99**

ColorSync 20" Display (19" VIS)
(APP M6162LL/A) **\$1499.99**

15.1" Flat-Panel Studio Display (15.1" VIS)
(APP M6356LL/A) **\$1299.99**

TDK CyberExpress 5600 56K V.90 modem (TDK U6600012) **\$99.99**

PNY 24MB Memory Upgrade from PNY Technologies (PNY PM450724) **\$149.99**

PNY 48MB Memory Upgrade from PNY Technologies (PNY PM450748) **\$199.99**

Apple® Macintosh® PowerBook® G3

with 233MHz PowerPC™ G3 processor and 14.1" TFT Active-Matrix Color Display

- 32MB SDRAM •2GB hard drive •20x CD-ROM drive
- 1.4MB Apple SuperDrive® •66MHz system bus
- Built-in 10BASE-T ethernet •4MB SGRAM video memory

\$1999.99

(APP M6484LL/A)....

TDK CyberExpress 5600 56K V.90 PCMCIA modem..... (TDK U6600012).... **\$99.99**

PNY (for 32MB, 64MB, or 128MB PNY Memory Upgrades, see below) **PNY**

PNY Technologies Upgrade REBATES!

RAM Memory Upgrades Improve Performance and Speed!

- (for G3 PowerBooks & iMac)
- 32MB (PNY PAPMG3WS32) **\$69.99**,
after \$10 PNY Rebate
 - 64MB (PNY PAPMG3WS64) **\$129.99**,
after \$20 PNY Rebate
 - 128MB (PNY PAPMG3WS128) **\$269.99**,
after \$30 PNY Rebate



(rebates expire December 31, 1998)

- (for G3 Desktops & MiniTowers)
- 32MB (PNY PAPMG332CS) **\$49.99**,
after \$10 PNY Rebate
 - 64MB (PNY PAPMG364CS) **\$129.99**,
after \$20 PNY Rebate
 - 128MB (PNY PAPMG3128CS) **\$199.99**,
after \$30 PNY Rebate

Join the Apple® iMac™ Generation!

Apple® Power Macintosh® iMac™ G3 Computer

- 233MHz PowerPC™ G3 processor •32MB SGRAM •4GB hard drive
- 24x CD-ROM •Built-in 15" monitor (13.8" VIS) •2MB video RAM
- 56Kbps V.90 modem •Cable modem ready

\$1299.99! (APP M6709LL/A)



PowerPC and the PowerPC logo are trademarks of International Business Machines Corporation, used under license therefrom. Apple, the Apple logo, Macintosh, Power Macintosh, PowerBook, Apple are registered trademarks of Apple Computer, Inc. Zip drive is a trademark of Iomega Corporation. © 1998 Apple Computer, Inc. All rights reserved. Apple, the Apple logo, Macintosh, Power Macintosh, and PowerBook are registered trademarks of Apple Computer, Inc. All other trademarks are the property of their respective owners. All Apple products are designed to be accessible to individuals with disabilities. For more information in the U.S., call 1-800-FOR-APPLE in TDD: 1-800-539-2220

J&R CORPORATE SALES BUSINESS LEASING:

No Money Down, No Payments for 30 Days!



Call J&R Corporate Sales at
1-800-221-3191 or 1-212-238-9080

Order from
www.jandr.com
AOL Keyword: J&R

To Order Toll Free and Receive a Free Catalogue

24 Hours, 7 Days, Anywhere In The USA
800-221-8180

PARK ROW • NEW YORK • NY • 10038 FAX: 1-800-232-4432

Not responsible for typographical or pictorial errors. Merchandise is brand-new, factory-fresh & 100% guaranteed! Some quantities may be limited. Choose 282 at www.macworld.com/getinfo



All Major Credit Cards Accepted
Overnight Delivery Available!

Order Code: MW901
(prices good until 1/31/99)

Macworld



SAN FRANCISCO

COMING SOON!

JANUARY 5-8, 1999

MACWORLD EXPO

SAN FRANCISCO

MOSCONE CENTER

BOOTH # 1207

Only Macworld Live provides live coverage everyday at Macworld Expo featuring:

- » *Keynote Analysis with Macworld editor-in-chief, Andy Gore*
- » *Interviews with Industry leaders: Apple, Mitsubishi, Dantz and others!*
- » *Q&A with your favorite IDG Books authors, like David Pogue, Bob Levitus and more!*
- » *The Winners of the 1998 Eddys*
- » *The Hot Seat: the latest Mac products are put through their paces*
- » *Macworld "Best of Show" Winners*

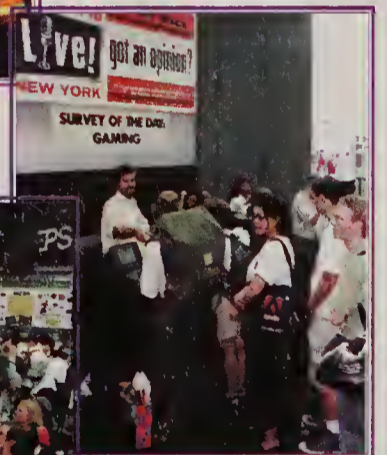
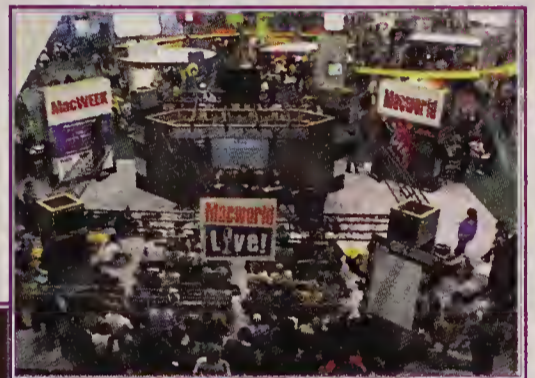

PLUS!

WIN! WIN! WIN! WIN!

In the Macworld Live Ultimate Sweepstakes!

4 times a day—every day of the show!

Brought to you by:

Macworld

«eMediaweekly»

ZDTV
NEWS

PRODUCT INDEX

| Category | Page No. | Category | Page No. |
|---|----------------|--|----------------|
| Business Operations | 154-155 | Graphics | 158 |
| Bar Code | | Clip Art | |
| Inventory Management | | | |
| Print Utility | | Systems & Peripherals . . . | 160-174 |
| Software | | | |
| Education/ | | Memory & Upgrades | 175-177 |
| Entertainment | 156 | Memory Upgrade | |
| Discount Software | | | |
| Communications/ | | Services | 178-179 |
| Networking | 157-158 | Printing | |
| Cross Platform | | Data Recovery | |
| Modems | | Digital Production | |
| | | Repair | |
| Peripheral Products | 158-160 | | |
| Digital Media | | Shopper Account Manager: | |
| Magnetic Media | | Carol Johnstone.....415-243-3691 | |
| Cd Rom | | carol_johnstone@macworld.com | |
| | | | |
| Digital Advertising Coordinator: | | Shopper Account Manager: | |
| Mac Scott.....415.243.3510 | | Niki Stranz.....415-243-3664 | |
| mac_scott@macworld.com | | niki_stranz@macworld.com | |

PrintChef® – "it's not printing magic, it's printing science..."

When it comes to printing:

- Booklets**
- Toner/Ink Control**
- New Paper Sizes**
- Multi-Ups & Labels**
- Mail Merging**
- Bar Codes**
- Logging & Security**
- Collected Files**
- Sign Your Faxes**
- Serialization**
- Tiling & Banners**
- Letterheads**
- Previews & Covers**
- Fronts & Backs**
- to your design...**



...there is no equal!

print different™

Add the **printChef** button to your print dialog today...

- Street priced at **\$60**
- ~~\$95~~ **printChef®** (personal)
- \$45 "Tiling Helper"
- \$35 "Fill-in-the-Blank"

\$350 printChef Pro
60-day money-back guarantee

printChef is a print extension that sits between any application & any printer driver... it uses Print Recipes that you design to control any application's output...

*Tiling Helper is a printChef plug-in. MindGate, printChef, and their logos are registered trademarks. "print different", Tiling Helper, Fill-in-the-Blank, PrintTracker, and PrintBuilder are trademarks, and "It's not printing magic, it's printing science" are salesmarks of MindGate Technologies, Inc.

To boost the printing power of **any application**, call **(800) 648-6840**...or try our demos, print recipes, & multimedia tutorials at **www.mindgate.com**

...for International callers
Worldwide: (931) 937-6800
Fax Orders: (931) 937-6801



MindGate® Technologies, Inc.
164 Oliver Smith Road
Flintville, TN 37335-5335

Order direct from us



Choose 401 at www.macworld.com/getinfo

<http://www.scientific.com>

Professional Software Developers

Looking for career opportunities?

Check out our website!

- Nationwide Service
- Employment Assistance
- Resume Help
- Marketability Assessment
- Never a fee

Scientific Placement, Inc.

800-231-5920 • 800-757-9003 (Fax)
das@scientific.com

Create your own bar code graphics.



Imagius
-Imaging Magazine

CALL FOR FREE DEMO

Bar Code Pro® v3.5 with Veribar®

For guaranteed readability!

SNX www.snx.com Call 800 619-0299
Tel 718 499-6293 Fax 718 768-3997

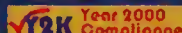

Create perfect PostScript (EPS) bar code graphics for Quark, PageMaker, Illustrator, Freehand, etc. All popular bar code types (UPC, Postnet, 39, EAN, 128, ITF, ISBN) included. Works with any printer resolution, with no fonts required! Mac/Win95/NT

Choose 402 at www.macworld.com/getinfo

Bar Code Headquarters



- 30 Day \$ Back Guarantee
- Free Shipping in USA
- Toll Free Tech Support

- Portable Batch Readers
- Cordless Interactive RF Bar Code Readers
- ADB Bar Code Readers
- Wand, Laser, CCD, Magstripe or Slot Badge
- PostScript Bar Code Fonts

WORTHINGTON
DATA SOLUTIONS

1-800-345-4220

Or Call 831-458-9938

Website: www.barcodehq.com



"A Macworld never goes by without me checking to compute prices. I always look to see if what I need is there."
-Owner, Computer Consultants

Macworld
SHOPPER

MBC³ The new version of MacBARCODA

Over 170 bar code variations! A totally new MacBARCODA package including over 30 variations of Code 128, UPC, PostNET, ITF, Codabar, Code 39, book and magazine codes, coupon codes, SSC codes and much more!
• Apple Scriptable! • Color control! • Most accurate bar code creator available! • Unlimited free telephone support
• PowerMac and OS8 compatible and 68000/System 7.x

Also PostScript & Thermal Label Printing Solutions

Computalabel
INTERNATIONAL

28 Green Street, Newbury, MA 01951
Tel: 800-289-0993 Fax: 978-462-9198
www.zoo.co.uk/~computalabel

Finally, a Powerful Thermal Transfer Printer for FileMaker Pro[®], Quark[®], Illustrator[®], or Mac-Barcode[®] ProLabel!

One Stop Shopping with Friendly Support from the Experts. Call Us for Free Bar Code Consulting and Information.



Mobile!



Simple!



Fast!



Accurate!

- Mac-Barcode[®] ProLabel v2.0
- Desktop SmartScanners for Windows & Mac
- Thermal Transfer Printers
- Walk-About for Newton[®] and Other HPC's

The Mac-Barcode Co.

The Mac-Barcode Co.
800-733-7592

or Visit Our Web Site at:

www.mac-barcode.com

Tel: 508-746-4242 Fax: 508-746-6030

Choose 404 at www.macworld.com/getinfo

POINT OF SALE • INVENTORY CONTROL

Software & Hardware for:

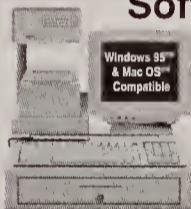

Now iMac compatible

- Retail/Wholesale
- Mail Order
- Internet Commerce
- Rentals
- Service/Repair
- Manufacturing
- FileMaker Tools

Fully Integrated Accounting
Multi-Site Polling • Cross Platform
Barcode Readers • Receipt Printers
Cash Drawers • Mag Stripe
Ribbons/Paper/Labels
Credit Card Authorization
& Deposit Software

www.posdirect.com

(800) 622-7670 • sales@posdirect.com

(618) 985-8237 vox • (618) 985-3014 fax

P.O.S. DIRECT



Order Free CD Rom on Web Site

BAR CODE SOLUTIONS

FREE EXPERT CONSULTATION!

FREE LIFETIME TECHNICAL SUPPORT!

MONEY-BACK GUARANTEE!

UPC/EAN, CODE 39, ITF, POSTNET, 2-D, and more!



"This is the best product of it's kind, and it's reasonably priced too."

-MacUser on PrintBar For Macintosh

Download Demo Software and Fonts Online at: www.bearrock.com

- BAR CODE FONTS
- LABELING SOFTWARE
- SCANNERS/LASERS
- GRAPHIC UTILITIES

Call Today to Order Your Free Bear Rock Product Pack and Receive "Bar Code Basics: A Quick Reference Guide to Understanding Bar Codes and How to Create, Print, Read and Successfully Use Them."

International Bar Code Expertise

Over 300,000 Products Sold Worldwide in 10 Languages

800-232-7625

International: 530-672-0244

Fax: 530-672-1103



Attn: Students-Teachers-Schools

| | |
|---------------------|---------------------|
| Authorware \$399 | KPT Bryce 3D 115 |
| CodaFinale97 245 | LightWave 5.5 889 |
| Debab.Toolbox 279 | MiniCAD 7 315 |
| Director 6 339 | MS Office 98' 199 |
| Dreamweaver 149 | MS Word 6.01 99 |
| Electric Image 1329 | Norton Utilities 65 |
| Eye Candy 3.0 74 | Painter 5.0 205 |
| FileMaker Pro 135 | PageMaker 6.5 call |
| Final Draft 4.1 145 | Photoshop 5.0 call |
| FireWorks 1.0 call | WordPerfect 3.5 49 |
| Flash 2.0 145 | |
| GoLive Cyber.3175 | |
| Kai's PowerT. 79 | |

*We accept Purchase Orders from schools.
*Call for Adobe, Microsoft & QuarkXpress!!

1-888-416-4555
www.ace-soft.com

STUDENTS, TEACHERS, SCHOOLS SAVE UP TO 80%

We'll Beat ANY Advertised Price!!



Adobe Illustrator 7.0 Adobe Photoshop 5.0 Adobe PageMaker 6.5

The Worlds Leading Desktop Publishing Bundle

Adobe, Microsoft, Lotus, & Borland products also available at the same great discount.

| | | |
|---------------------------------|---------------------------------|---------------------------------|
| 3D Suite 3.0 299 | FileMaker Pro 4.0 109 | PageTools 2.0.1 69 |
| 4th Dimension 6.0 E-Doc. 295 | Final Draft 4.1 145 | Pointer 3D 99 |
| Authorware 4.0 E-Doc . . 375 | Final Effects Complete. . 249 | Pointer 5.5 Web. 199 |
| Convos 5.0.3 179 | Fireworks 99 | Phototools 2.0 69 |
| Cliff Notes Studyware. . . 19 | Flosh 3.0 99 | Poser 3.0 109 |
| CodeWarrior Pro 3.0 . . . 119 | FreeHand 8.0 139 | PreFlight Pro 279 |
| Conflict Catcher 4.0.1 . . . 59 | HomePage 3.0 55 | QX-Tools 2.0 89 |
| CorelDRAW Suite 6.0 . . . 139 | Infini-D 4.5 279 | Roy Dream Studio 5.0 . . 129 |
| CyberStudio 3.0 179 | Inspire 3D 269 | Roy Dream 3D 69 |
| Debabelizer 3 299 | Kai's Power Tools 3.0 . . . 79 | Softwindows 95 5.0 . . . 199 |
| Director 6.5 E-Doc 345 | KPT Bryce 3D 3.0 115 | Strota Medio Point 1.2 . . 179 |
| Director MMS 6.5 675 | LightWave 3D 5.6 895 | Strota Studio Pro 2.5 . . . 545 |
| Director MMS 6.5 Upg . . . 399 | LivePicture 2.6 199 | Total Xaos Bundle 119 |
| Dreomweaver 1.2 99 | Logomotion 2.1 65 | Videoshop 4.0 3D 159 |
| Electric Image 2.8 1329 | Mathemotico 3.0 Stu . . . 149 | VirtualPC 2.1 Win98 . . . 159 |
| Encore 4.2 279 | Mosk Pro 189 | Wacom Intuos 4x5 155 |
| EndNote 3.0 99 | MiniCAD 7.0.1 315 | Wacom Intuos 6x8 285 |
| Expression 99 | NetObjects Fusion 3.0 . . . 99 | Wacom Intuos 9x12 399 |
| Eye Condy 3.0.1 75 | OmniPage Pro 8.0 329 | WordPerfect 3.5.1 35 |

WebSite www.electronicimage.com • Fox (925) 798-2464 • FREE Catalog

1-888-3-EDU-8-SOFT-3

STUDENTS!

Save up to 75% OFF Popular Software!

Call for a FREE Student Software Guide: **(800) 874-9001**

Adobe • Microsoft • Autodesk
Kinetic • Corel • Macromedia
MetaCreations • Wacom
Symantec • Extensis • More!

www.JourneyEd.com

JOURNEY Education Marketing

CALL FOR A FREE CATALOG: (800) 874-9001

MacWorld / **Get** **Info**

www.macworld.com/getinfo

MacWorld's
NEW Online
Reader
Service

Academic Discounts

The Software Showcase

CyberStudio Pro 3.1 \$179
Design fully dynamic web sites

FileMaker Pro 4.1 \$99
award-winning relational database

Flash 3.0 \$99
Interactive vector graphics and animation for the web.

Fireworks 1.0 \$99
The only web graphics design software you need

Savings for Students, Teachers, & Schools!

Visit our Web Site- <http://www.softwareshowcase.com>

| | |
|--|--|
| Auto FX Photo Edges 1,2 or 3 \$ 99.00 | lomega ZipPlus 100 \$ 195.00 |
| BBEdit 4.5.1 \$ 79.00 | Kai's Power Tools 3.0.2 \$ 85.00 |
| Bons FX 3.5 \$ 329.00 | KaleidaGraph 3.0 \$ 119.00 |
| Bryce 3D \$ 119.00 | LightWave 3D 5.6 \$ 899.00 |
| CADtools 1.1 \$ 99.00 | Mac Academy Videos \$ 35.00 |
| Canvas 5.0.3 \$ 179.00 | MacDraft 4.3 \$ 145.00 |
| ChemDraw Standard 4.0 \$ 199.00 | MagicMask \$ 75.00 |
| ClarisWorks 5.0 Office \$ 99.00 | Mathematica 3.0 Student \$ 149.00 |
| Coda Finale 98 \$ 269.00 | Matlab 5.0 Student \$ 99.00 |
| CodeWarrior Pro R4 \$ 119.00 | MiniCAD 7.0.1 \$ 339.00 |
| Color III 3.2 \$ 39.00 | Myrmidon 2.1 \$ 39.00 |
| ColorDrive 1.5.3 \$ 89.00 | Neal's Type Efix \$ 79.00 |
| Conflict Catcher 4.0 \$ 59.00 | Net Objects Fusion 3.0 \$ 99.00 |
| Creator2 1.1 \$ 149.00 | Nisus Writer 5.1 \$ 79.00 |
| DeBabelizer 3.0 \$ 299.00 | ObjectDancer 1.5 \$ 199.00 |
| Director 6.5 EDoc \$ 349.00 | Painter 5.5 \$ 219.00 |
| Director 6.5 Studio \$ 679.00 | PhotoTools 2.0 \$ 89.00 |
| Doubler Pack \$ 69.00 | Poser 3.0 \$ 125.00 |
| Dreamweaver 1.2 \$ 99.00 | RayDream Studio 5.0 \$ 125.00 |
| ElectricImage Broadcast 2.8 \$ 1399.00 | SoftWindows 98 5.0 \$ 169.00 |
| EndNote 3.0 \$ 165.00 | StudioPro 2.5 \$ 549.00 |
| Eudora Pro 4.0 \$ 35.00 | Stuffit Deluxe 4.5 \$ 59.00 |
| Eye Candy 3.01 \$ 79.00 | Terran Media Cleaner Pro 3.1 \$ 199.00 |
| FLIGHTCHECK 3.4 \$ 199.00 | Test Strip 2.0.2 \$ 89.00 |
| Final Draft 4.1 \$ 149.00 | Textbridge Pro \$ CALL |
| Form Z 2.95 \$ CALL | Total Xaos \$ 119.00 |
| FreeHand 8.0 \$ 99.00 | VideoShop 3D 4.0 \$ 149.00 |
| Genuine Fractals \$ 129.00 | Virex 5.8 \$ 69.00 |
| HoTMetaL Pro 3.0 \$ 75.00 | Virtual PC 2.1 w/Win 98 \$ 159.00 |
| HomePage 3.0 \$ 59.00 | VirusScan 3.0 \$ 39.00 |
| HyperStudio 3.1 \$ 119.00 | Wacom Intuos 6x8 Tablet \$ CALL |
| Inspiration 5.0 Higher ED \$ 79.00 | WebSTAR 3.0 \$ 329.00 |

\$299 Includes:
Ray Dream Studio 5
Poser 3
Bryce 3D
Painter 3D
3D Suite 3.0

\$79 21 Photoshop compatible plug-ins that create special effects that would normally take hours by hand
Eye Candy 3.0.1

\$219 Painter 5.5 Web Edition goes beyond the traditional with exciting plug-in brushes!
Painter 5.5

Call for a FREE Catalog (800) 699-1836
Priority Code: 1000

We will beat any Advertised Price!!! "Call For Pricing On COREL Products"

(800) 699-1836

Software ShowCase Inc. 417 Euclid Ave, Loch Arbor, NJ 07711
Phone (732) 660-8820 Fax (732) 660-8828 "School P.O.'s Welcome"

Ports for Your PowerMac!

SX Serial Card

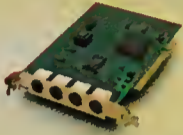

"Fast, Solid and Reliable" - MacWorld

Better than a Switch or Juggler

- Provides simultaneous, trouble free use of multiple serial devices
- 2 or 4 port PCI serial cards available
- For Comm Toolbox savvy software
- SX-2 just \$199 SX-4 only \$299

Keyspan USB Card



Add USB to your PowerMac

- PCI card with 2 USB ports
- Use all the new USB devices on your existing Mac
- UPCI-2 just \$59!

Expand your iMac!

Keyspan USB Serial Adapter

Add 2 Mac serial ports to your iMac

- For use with tablets, PDAs, cameras and many printers
- Get two ports for the price of the single port solutions!
- USA-28 just \$79

Keyspan USB Hub

Connect more USB devices to your iMac

- USB compliant 4 port Hub
- UHUB-4X just \$69



USB Cables

- 6 ft. Device Cable (A-B) \$10
- 6 ft. Extension Cable (A-A) \$12

All products include 5 year warranty



www.keyspan.com (510) 222-0131

The Mac Zone (800) 213-6356
code: KWM8

Choose 408 at www.macworld.com/getinfo

CADMOVER v.5

What good is a built in translator if it doesn't work?

You've worked hard and now it's time to use those files in another program. You try to import them & all you get is garbage. Not with CADMOVER. For over ten years we've been helping people beat their deadlines, no re-drawing, no touch-ups.

File formats: DWG, DXF, EPSF, PICT, CGM, IGES, HPGL, STL, MiniCAD, DDES2, etc... Internal Features: scaling, 2D/3D views, font mapping and more. With 17 decimal place accuracy redrawing is a thing of the past.

800-579-2244 <http://www.kandusoftware.com/macworld>

KANDU
software corporation

Choose 409 at www.macworld.com/getinfo

"I always look at the entire Macworld Shopper section to see what is available. I also like to check the prices of all the different products."

-Owner,

Computer Consultants

Macworld
SHOPPER

LifeART Professional Medical Clip Art



www.lifeart.com 1-800-543-3278

Mac[®] Networking at PC Prices!



253-User Internet Sharing Hub

The New PalmRouter Elite

- All you need:
- One PalmRouter Elite
 - One modem
 - One ISP account

Now with:
DHCP Server
Web-Configuration
2-serial ports
and much more...

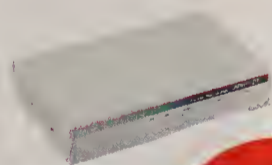

\$299

For Mac & PC

Totally Redesigned

Fast Ethernet CardBus Card

\$129

New

Now you can network your PowerBook G3 at 10/100 Mbps with our new high performance 32-bit PC card. Get 100/200 Mbps with our Full-Duplex technology.



Upgrade your existing PalmRouter today
See web site for details

Stop Paying High Prices

Stop

Stop Paying for Low Quality

USB FunStick & FunPad for iMacs

Now play your favorite games on your iMac with the FunStick and FunPad. 8 Fully programmable buttons and more.

New



Palm Size N-Way 2-Port Switch

Worlds' Smallest Switch
Worlds' Smallest Price

\$119

New

Connect 10 and 100 Mbps Mac & PC Users to the same network.

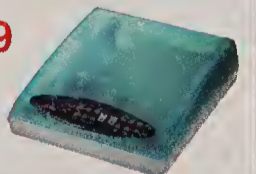

Other Products: LC PDS, NuBus, PCMCIA Ethernet cards • SOHO, Dual Speed, Switch Hubs • Transceivers, SCSI & LVD Terminators

Macsense products available through

All Macsense Products Include:

Please call or e-mail for FREE product catalog

ClubMac MacMall **The Mac Zone** MacWAREHOUSE



Free Technical Support

Macsense Connectivity Inc.
Tel:1-800-642-8860 Fax:408-744-1060
1290 Reamwood Ave.#B Sunnyvale, CA 94089
<http://www.macsenstetech.com>

CD-ROM PRODUCTION

1000 Retail-Ready Stamped CDs

Includes two color discs, four color glossy insert & tray cards, jewel case, and poly wrap. Complete turnkey — just send a CD-R and art files! Call for details.



CATALOGIC

Your CD-ROM Production Source™
<http://www.catalogic.com>

935 Sierra Vista Avenue • Mountain View, CA 94043
Telephone: 650-961-4249 Fax: 650-962-5333

- Easy to use labeling kits
- CD-R silk screening service
- Short run CD-R duplication
- 4.1Gb/hour standalone duper

CD-R media as low as \$1.49

800-255-4020



BONUS 5 CDR FREE TEAC 4X12 CD-R bundle... **\$399**

BONUS 5 CDR FREE Panasonic 4x8 CD-R bundle.... **\$295**

BONUS 5 CDR FREE Jaz 2GB 4x2x6 CD-RW exter. bundle... **\$845**

BONUS 5 CDR FREE Yamaha 4x2x6 CD-RW bundle... **\$395**

NEW Fastest CD-R 8x20 bundle... **\$699**

CD-R BLANKS as low as **99¢** also available TDK & More

Pioneer DVD Recorder bundle.. **\$16,499**

AFFEX CD Color Printer bundle, 1440 dpi. Prints 2 CD at a time..... **\$1,399**

CD-RW Media. **\$13** DVD R-Media. **\$59**

Shimad 1-888-4-SHIMAD toll free 888-474-4623
P.H. 650-493-1234 <http://www.shimad.com> FAX: 650-493-1333

MediaFORM DUPLICATOR:
3704 Autoloader CD2CD... **\$7,499** **\$2,399**
5900 8CD-R... 2701 autoloader... **\$5,999** **\$4,899**

FOR CD DUPLICATION...CALL
Jaz cart. as low as...
1GB \$79 2GB \$99
SyJet cart...\$59
Zip cart....\$10



Yamaha 4260
4x/2x/6x CD-RW Drive
\$389

All drives include Adaptec Toast 3.5.5 & Direct CD, Cables, Media & Toll Free Support!
External **\$449**



Mitsui CD-R
\$1.39

200 Pack in Jewel Case
Generic High Grade 99¢

Sanyo 8x/20x CD-R Drive

\$649

All drives include Adaptec Toast 3.5.5 & Direct CD, Cables, Media & Toll Free Support!
External **\$699**



www.mediasupply.com

New Hours!
8:30am to 8:00pm EST.

800-944-4237

400 Eagleview Blvd. • Exton, Pennsylvania 19341
Phone: 610-458-9100 • Fax: 610-458-9464

Networking Macs and PCs Leave You Stranded?

Let PC MACLAN Save You . . . Time, Money and Resources

Now whether you're a small business, home office or workgroup you can operate as efficiently as a corporate network with PC MACLAN — the leading solution for sharing printers, files, drives and more between Mac OS and Windows PCs, including remote and internet access.

- Add PCs to a Mac-based Network
- Print to AppleTalk or PostScript Printers from a PC
- Share Drives, Email and Applications Cross-platform

PC MACLAN is available for Windows NT, Windows 95 and Windows 3.x . . . and at our prices, PC MACLAN won't drown your networking budget!

www.miramarsys.com
1-800-862-2526



"For peer-to-peer networking . . . PC MACLAN 6.0 is the only choice."
— Macworld - Nov '96

Windows 95, Windows NT, Windows 3.11, Windows 3.11

Redefine your environment

"If we had to place just one ad, it would be in Macworld Shopper.

It just plain works better for us than the others ...

We know, we've tried them."

—David Ash
Mac Solutions

Macworld
SHOPPER

CD-ROM SERVICES

AMC IS

AMC's Imaging and Information Services division can provide:

- Mastering
- Copying
- Duplication
- Printing
- Packaging
- Silkscreening

Call us at **888.454.0100** or visit our website at: www.amciis.com



MW0199

visit us online at: www.mwm.amc-direct.com

NEW LOWER PRICE!



CD RECORDERS

Only: External **\$359.** Internal **\$299.**

AMC DiscWRITE

SECURE ONLINE ORDERING!

AMC DiscWRITE 4x8 CD RECORDERS



We've just lowered the price on all of our CD-R and CD-RW drives, and this month we're featuring our 4x8 external recorder for only \$359! Be sure to call or check out our website today to take advantage of this and other hot deals!

AMC DiscWRITE 4x8 RecorderExternal **\$359.** Internal **\$279.**
Yamaha 4x2x6 CD-RWExternal **\$459.** Internal **\$339.**

CD-R DUPLICATORS

NEW LOWER PRICE!

CALL!

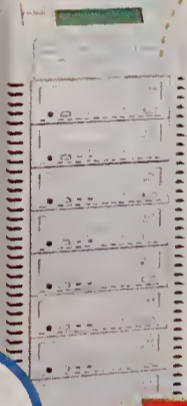

BUY NOW and receive up to 100 blank CD-R's FREE!

MEDIAFORM CD-5900

The CD-5900 will duplicate up to 24 650mb CD-R's per hour, and with add-on tower units can duplicate up to 64 CD's simultaneously. *That's almost 100 CD's per hour!* Call for all of the details on this new low priced powerhouse from MediaFORM & AMC.

MediaFORM Duplicators-selected as E-Media Magazine's "Editor's Choice" 2 years in a row!

Other MediaFORM models available:

- CD-5300 (1-4) CD Duplicatorstarting at **\$3,095.**
- CD-5100 Desktop CD Copier**\$1,499.**
- CD-2701 50 CD Duplicator*new lower price!* **\$4,999.**
- CD-3704 100 CD Duplicator **NEW!****CALL!**
- CD-3707 200 CD Duplicator **NEW!****CALL!**

* Offer good only on select MediaFORM CD-ROM Duplicators. Call for details.

CD-R PRINTERS

PRIMERA SIGNATURE COLOR CD PRINTER

\$1,195.

The Signature CD Color Printer from PRIMERA is the perfect way to add a professional touch to your CD-R's.

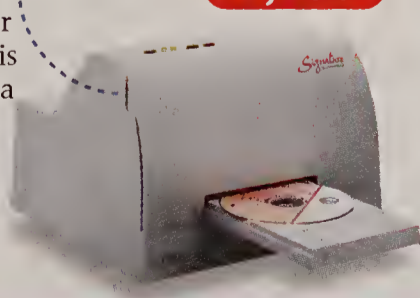

PRIMERA
TECHNOLOGY, INC.

CD-R MEDIA

mitsui

RICOH

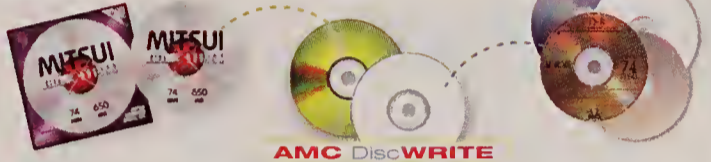

AMC DiscWRITE

- DiscWRITE Blank (no logo) 50 pk w/ jewel case**\$69.99**
- Mitsui CD-R (silver) 25 pk w/jewel case**\$49.99**
- Mitsui CD-R (silver) 100 pc spindle**\$159.99**
- Ricoh Printable CD-R (white or champagne) 100 pc bulk ...**\$159.99**
- Ricoh CD-R (platinum) 100 pk w/ jewel case**\$159.99**
- AMC DiscWRITE special formulation CD-R Pens 4 pk**\$6.95**

Check our website for other types, quantities & specials!

iMAC PERIPHERALS



FOR USB - CALL AMC!

AMC has a complete selection of USB peripherals for your iMac, including scanners, printers, digital cameras, joysticks, etc.

Call or visit our website at www.amc-direct.com for our complete USB selection!

AMC carries products from these and other fine manufacturers:

888.215.3937

CD COPIER

Please call or visit our web site for more info. on all of our products.



Rapid CD Duplication service also available.

PRINCETON DIS From \$1495
800-426-0247
www.princetondisc.com

DFI 20" SONY COLOR MONITOR

ONLY \$449!
One Year Warranty

800-390-7020
181 Salem Street, Malden, MA 02148

| | |
|-----|----------|
| 14" | -\$ 99! |
| 17" | -\$ 239! |
| 19" | -\$ 499! |

VISA MasterCard DISCOVER

HANGARDECK YOUR COCKPIT COMMAND CENTER....

The "HANGARDECK" computer desk stores all your hardware and wiring inside(except for the monitor and keyboard), leaving your workspace free for action! All in a 32"x 48" space!



This "clear the decks" environment is quiet, dust-free, attractive, and it locks!

Email: info@robodesk.com
Call: 248-435-0075
Website: www.robodesk.com

Choose 415 at www.macworld.com/getinfo

Mac Pro Systems & Software

Since 1988

Buy • Sell • Trade • Upgrade • Repair
New • Used • Refurbished

Small Ad **Lowest Prices**

Any Ad is a Mac Pro Ad
Check out our Wholesale Specials @
www.mac-pro.com

800-525-3888
fax: 408-369-1205

USED MACS & POWERBOOKS

FOR SALE WANTED

| | | |
|-------------------|--------------------|--------|
| 8500/120 | 16/1gb/CD | \$ 850 |
| 6400/180 | 16/2gb/8x/28.8 | 625 |
| 7200/90 | 8/500/CD | 600 |
| 7200/75 | 8/500/CD | 550 |
| 7100/66 | 8/500/CD | 525 |
| 6100/60 | 8/230 | 350 |
| PwrBk G3/266 14.1 | 64/4gb/20x/56k | 2,850 |
| PwrBk 3400c/180 | 16/1gb/8xCD refurb | 1,375 |
| PwrBk 1400c/117 | 16/1gb/6xCD refurb | 1,125 |
| PwrBk 1400cs/117 | 12/750 refurb | 900 |

Prices subject to change. Limited to stock on hand, subject to prior sale. Call for up-to-the minute inventory & prices.

WE BUY USED MACS! TOP \$\$\$ PAID

Any Quantity • FedEx check delivery
Fax a list for a quote (310) 966-4433

11933 Wilshire Bl., W. Los Angeles, CA 90025
MAC Solutions www.macsolutions.com
(800)873-3726 **(800)80-WE-BUY**

A Macworld store goes by your home, checking to compare prices, always looking for what you need, a great price, a great deal.

Macworld SHOPPER

Save On Reconditioned Macs & Peripherals From DataTech

HOLIDAY SPECIALS

Centris 650 8/230... **\$169**

\$179... LaserWriter IIxt

| OLDER MACS | | POWERMACS | |
|------------------------|-------|---------------------------|-------|
| Mac LC 4/40..... | \$59 | 6100/66 8/350/CD..... | \$379 |
| Mac IIsi 5/40..... | \$59 | 7100/66 16/230/CD..... | \$379 |
| Mac IICI 8/80..... | \$89 | 7100/80 24/700/CD..... | \$449 |
| Mac IIVx 8/80..... | \$109 | 8100/110 24/2GB/CD..... | \$549 |
| CENTRIS/QUADRAS | | 7500/100 24/1GB/CD..... | \$649 |
| Centris 610 8/230..... | \$149 | 7600/120 24/1GB/CD..... | \$749 |
| Quadra 605 8/160..... | \$169 | 8500/120 32/2GB/CD..... | \$799 |
| Quadra 610 8/230..... | \$179 | 9500/132 32/2GB/CD..... | \$899 |
| Quadra 650 8/230..... | \$229 | MONITORS | |
| Quadra 800 8/230..... | \$249 | Apple 14" Color Plus..... | \$129 |

Apple 14" Trinitron..... \$169
Apple 14" MultiScan..... \$199
Apple 15" MultiScan..... \$229
Apple 17" MultiScan..... \$299

PRINTERS
LaserWriter IIxt..... \$179
LaserWriter IIxtx..... \$229
HP 4mv (11x17)..... \$1099

- All CPUs include mouse
- 6-month warranty
- VISA & MasterCard accepted

To ORDER CALL
1-800-281-3661

DataTech
REMARKETING, INC.

Tel: 615-860-4422
Fax-On-Demand: 615-860-0109
Fax: 615-860-0390
Web: www.datatech-rmkt.com
471 Myatt Dr., Madison, TN 37115

MacWorks 800-482-2705

Serving the Macintosh community since 1994.

e-mail: sales@macworks.com
Voice 913.599.6227 • Fax 913.599.6111 • 9am-6pm Mon-Fri CST
Prices Subject to Change • Visa/MasterCard/AmEx
We only ship FedEx • 15% minimum restocking fee on all returns

| PowerMac Bundles | Used Desktop Macs | Apple CD-ROM Drives | Apple Video Upgrades | Apple Processor Cards | Apple StyleWriters |
|---|--|--|--|---|---|
| PowerMac 7100/80 16/500/CD Apple 14" Color Display Keyboard/Mouse/Modem Other Bundles Available ONLY \$599⁹⁹ | PowerMac 7600/120 \$699⁹⁹ PowerMac 7200/90 \$499⁹⁹ Quadra 650 24/230/CD \$299⁹⁹ Quadra 840av 16/250/CD \$249⁹⁹ Quadra 630 8/160/CD \$249⁹⁹ Quadra 610 8/230/CD \$249⁹⁹ Quadra 605 12/160 \$199⁹⁹ | Apple 3600i (24x) \$179⁹⁹ Apple 1200i+ (8x) \$129⁹⁹ Apple 600i+ (4x) \$99⁹⁹ Apple 300i+ (2x) \$49⁹⁹ | Apple Video System \$29⁹⁹ Apple TV/Video System \$49⁹⁹ Apple MPEG Media System \$20⁹⁹ *with video system purchase | Apple 604/132 \$199⁹⁹ Daystar 604e/200 \$149⁹⁹ Apple 604e/200MP \$399⁹⁹ Apple 61xx DOS \$299⁹⁹ | Refurbished Incl. New Ink 90-day Warranty LocalTalk & Ethernet available Color SW 2500 \$179⁹⁹ Color SW 1500 \$149⁹⁹ StyleWriter 1200 \$129⁹⁹ |

Apple Quantum 1.2 GB SCSI
• Internal Fireball/Terrapost drive
• make external for \$50 more
ONLY \$99⁹⁹

Apple GeoPort Adapter I **\$19⁹⁹**

FROM \$29⁹⁹

www.macworks.com

*** think mac ***

Liquidation

Macintosh CPUs

- Macintosh LCII 4/80 \$79
- Macintosh IIsi 5/80 \$99
- Macintosh Quadra 900 16/500 \$399
- Power Mac 6100/66 24/700/CD/DOS \$449
- Power Mac 7100/80 24/700/CD \$499
- Power Mac 7100/80AV 24/700/CD \$549
- Power Mac 8100/100 24/700/CD \$599
- Power Mac 8500/120 32/2GB/CD \$799
- Power Mac 8500/150 32/2GB/CD \$849

Monitors

- Apple 12" RGB Display \$99
- Apple 14" Color Display \$149
- Apple 15" Multiscan Display \$199
- Apple 17" Multiscan Display \$249
- Apple Multiscan 1705 Display \$299
- Apple 20" Multiscan Display \$549

Powerbooks

- Apple Powerbook 180 12/120/14.4 \$449
- Apple Powerbook 520C 12/160/19.2 .. \$499
- Apple Powerbook 540C 12/320/19.2 .. \$599

Printers

- Apple Color Stylewriter 1500 \$179
- Apple Laserwriter IIF \$299
- Apple Laserwriter IIG \$599
- Apple Laserwriter Select 360 \$599
- Apple Laserwriter Pro 630 \$699
- Apple Color Laser 12/600PS (Defects) \$499
- Hewlett Packard 4MV (11x17 Laser) ..\$1049

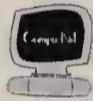

615-793-2277



Think Computer Kid.

PO Box 70 • 173 Industrial Blvd. • Lavergne, TN 37086 • PH: 615-793-2277 • Fax: 615-793-0837

MacBYTE

SERVING MAC USERS SINCE 1987

GREAT DEALS ON
REFURBISHED MACS NOW!

BUY • SELL • TRADE

CASH FOR MACS

NEW & USED MACS

WITH WARRANTIES

Local Area-On-Site Consulting



800-432-2983

12910 Culver Blvd., Suite H
Los Angeles, CA 90066
FAX: 310-448-4494

Choose 418 at www.macworld.com/getinfo

Mac POWER

Sales & Service, Inc.

BUY • SELL • TRADE
UPGRADE • REPAIR

New • Used • Refurbished

- Powrbooks
- PowrMacs
- Performas
- Quadras
- MacII-LC
- Monitors
- Printers
- Peripherals
- Ram
- Parts

Call now for best prices!

888-275-POWER

Fax: 408-448-6132
San Jose, California, 95123

Choose 419 at www.macworld.com/getinfo

FAST CASH

www.mactraders.com

For All Macs & Peripherals - Working or not

TOP DOLLAR PAID

Mac Traders (800)990-0995

(310) 664-0660 Mon.-Fri. 9 AM-6 PM Sat. 10 AM-4 PM (P.S.T.) Fax (310) 664-0665
2300 Lincoln Blvd. (One Light South of Pico), Santa Monica, CA 90405

BUY SELL TRADE

USED MACINTOSH!

ALL APPLE EQUIPMENT AVAILABLE!

New Year Blowout!

- PowerBooks
- PowerPCs
- G3s
- 68040 & 68030 MACs
- Large Monitors

School POs
Welcome

Apple Color Monitor \$49
with any \$500 purchase

CALL FOR DETAILS



The Computer Exchange

800.304.4639

sales/service: 404.355.5144 fax: 404.355.5461
500 Bishop Street • Suite E-3 • Atlanta, GA 30318

visit our new website: mistermac.com

Choose 417 at www.macworld.com/getinfo



Largest Selection
and Best Prices

DISTRIBUTION on Hard Drives

| | | | |
|-----------|-----------------------|-----|--|
| | C 610 8/160 | 99 | |
| | Q 610 8/230 | 125 | |
| | Q 650 8/230 | 150 | |
| | Q 800 8/230 | 199 | |
| All | 6100/60 16/250 | 299 | |
| | 7100/66 16/500 | 375 | |
| Desktop | 7200/75 8/500/CD | 399 | |
| | 7200/90 8/500/CD | 449 | |
| and Tower | 7200/120 16/1.2/CD | 499 | |
| | 7300/200 32/2/12X | 749 | |
| Models | 7500/100 16/1.2/4XCD | 549 | |
| | 7600/120 16/1.2/6XCD | 625 | |
| Come with | 7600/132 16/1.2/6XCD | 649 | |
| a mouse | 8100/80 16/1GB/2XCD | 525 | |
| | 8500/120 16/2GB/6XCD | 725 | |
| | 8500/180 32/2BG/CD | 799 | |
| | 8600/200 32/2GB/12XCD | 849 | |
| | 9500/132 32/2GB/12XCD | 799 | |
| | 9600/200 32/4GB/12XCD | 999 | |
| | 520C 4/160 | 399 | |
| | 540 12/240/modem | 399 | |
| | 2300c/100 8/750 | 499 | |
| | 5300/100 8/500 | 475 | |
| | 5300C/100 16/750 | 699 | |
| | 5300CE/117 32/1.1GB | 799 | |

Great
Warranties

HUGE
PARTS
INVENTORY

1251 Alma Court, San Jose, CA 95112

Phone: 408-280-1133 • Fax: 408-280-6840

Think
COMPUTER
REVELATIONS

ALL APPLE PARTS & ACCESSORIES IN STOCK
Leasing Rentals / Supplies
Service available in NYC area
1 800 275-9924
in NY 516 737-0800
FAX 516 737-0923
331E Dante Court
Holbrook, New York 11741
NEW & USED BOUGHT & SOLD

Mac Sales
www.macs4sale.com
Great Gifts!

Powerbook Duo 280c
Color Mac Laptop
40 MB Ram/1.2 GB HD
Sale \$449
add Duo Dock \$59

Computers

| | |
|--------------------------|------------|
| Centris 610 8/230 | \$199 |
| Centris 650 8/230 | \$249 |
| Quadra 660AV 8/230/CD | \$249 |
| Performa 635 8/250/CD | \$279 |
| Quadra 800 8/230 | \$349 |
| PowerMac 6100/66 16/160 | \$399 |
| PowerMac 7100/80 8/500 | \$499 |
| PB Duo 230 12/120/14.4 | \$199 |
| PB Duo 270c 12/320/14.4 | \$329 |
| Duo Dock & Dock II | \$79/\$149 |
| PowerBook 170 4/80/14.4 | \$279 |
| PowerBook 180 8/120/14.4 | \$449 |

Monitors

| | |
|---------------------|-------|
| 14" Apple Display | \$169 |
| 17" Apple Multiscan | \$299 |
| 20" Apple Multiscan | \$599 |

Printers

| | |
|----------------------|-------------|
| Laserwriter IINT | \$199 |
| Laser Select 300/310 | \$199/\$249 |

* Much More in Stock *
1-888-MACSALE
Buy • Sell • Repair • Parts
1-888-622-7253
Prices represent a Cash Discount.
Products are Used/Refurbished unless noted.

THE BEST IN REMANUFACTURED Macintosh COMPUTERS & PARTS

Holiday Specials!

- ✓ **Power Mac 6100/66** \$669!
24MB RAM/500MB HD/CD-ROM COLOR DISPLAY/KEYBOARD
- ✓ **Apple 17" Multiscan** \$399!
60% MORE WORK AREA THAN A 14" MONITOR
- ✓ **56K MODEM** \$69!
EXTERNAL, FOR MOST DESKTOPS
- ✓ **POWERBOOKS** \$399!
MODELS STARTING AS LOW AS

Pre-Owned Electronics
1-800-274-5343
Offices: 781-778-4600
Fax: 781-778-4848
VISIT US ON-LINE AT:
www.preowned.com

MacGlobal
SYSTEMS AND PERIPHERALS • SALES AND SERVICE

| | |
|---------------------|------------------------|
| Performas | PowerBooks |
| 410/466/476 Call | 520 4/160 \$399 |
| 550 5/160 \$450 | 520C 12/240/19.2 \$450 |
| 580 5/500/CD \$750 | 540C 4/320 \$650 |
| 631 8/500/CD \$450 | 5300 8/500 \$650 |
| 6200 8/1G/CD \$550 | |
| 5200 8/500/CD \$850 | Quadas |
| | 630 8/250 Call |
| | 650/800/840/950 Call |
| | Printers |
| Power Macs | Color Stylw Pro \$185 |
| G3 Call | Stylw II \$185.00 |
| 7200 8/500 Call | Stylw 1200 \$175 |
| 7500 16/500 Call | Laser 300 \$299 |
| 8500 16/500 Call | Laser 320 \$450 |
| | Laser 4/600 Call |
| | Monitors |
| Memory | 14" Color \$195 |
| 4 MB 72-pin \$12 | 15" App. Multi. \$265 |
| 8 MB 72-pin \$20 | 17" App Multi. \$450 |
| 16 MB 72-pin \$33 | 20" GS \$540 |

WE BUY!
WE REPAIR MACS!
TOP DOLLAR paid for memory, PowerBooks and CPUs!
[800] 722-8864
Phone: [408] 265-6653
Fax: [408] 265-6660

MacGlobal
Choose 421 at www.macworld.com/getinfo

HAWKE SYSTEMS
2550-A Chimney Rock Rd
Hendersonville, NC 28792
Fax - (828) 693-7271
Direct Dial - (828)-693-7170
Email - MacHawke@AOL.COM
(800) 875-2610

Specialists in Refurbished Macintosh Equipment

This Month's Specials Include:

- ImageWriter II Printer with Cable - \$89.00
- Apple Hi-Res Color Display with Cable - \$99.00
- Mac IISi 9/160 with Nubus adapter, Ext Kyb, Mouse
- Mac IICi 8/160 with Ext Kyb and Mouse
- Quadra 610 24/250 with Ext Kyb and Mouse
- Quadra 630 24/250 with Ext Kyb and Mouse
- Quadra 700 20/500 with Ext Kyb and Mouse
- PowerMac 6100/66/CD 24/500 with Ext Kyb and Mouse
- PowerMac 6200/75/CD 24/500 with Ext Kyb and Mouse
- PowerMac 6400/180 32/1.6/CD with Ext Kyb and Mouse
- Custom Configurations & 13", 14", 15" & 17" Monitor Packages Available for All Systems

Visit Our Web Site for a Full Listing & Current Pricing
www.MacHawke.com

Six Month Parts and Labor System Warranty

Service Parts

- New, Global Village Gold PowerPort Modems For 1xx Series - \$59.00
- New, Replacement Manual Inject (Black Flap) Floppy (w/t) - \$79.00
- Refurbished, Replacement Auto Inject (Open Slot) Floppy (w/t) \$59.00
- Pb 1xx Floppy Drives - \$109.00 Pb5xx Floppy Drives - \$119.00
- Call for other Parts, Logic Board Repairs and System Repairs

1-800-334-KIWI
Kiwi Computers • Save on refurbished Macs

Monthly Specials

Computer prices do not include keyboard, mouse or monitor.

- Performa 630 20/350mb CD.....\$249
- PowerMac 6100/60 24/500mb CD.....\$399
- PowerMac 6500/225 32/3 GB 12xCD 33.6.....\$825
- PowerMac 6500/275 32/4 GB 24xCD 56k ZIP.....\$999
- Powerbook 1400c/117 16/1 GB CD.....\$1149
- Performa 630 logic board (exchange).....\$75
- Performa 6200 logic board (exchange).....\$249
- Performa 630/6200/6300 power supply.....\$49
- PowerMac 6100/7100 power supply.....\$59
- Manual inject 1.44 internal floppy drive.....\$49
- Apple ADB mouse II.....\$15
- Internal 28.8 modem for P6400/5400/5500/6500.....\$38
- Platinum 28.8 internal modem for P5200/6200.....\$49
- GV internal 56k modem for PM6500/5500.....\$89
- 133mhz DOS card for 7" PCI.....\$149
- Apple 4 GB internal IDE hard drive.....\$149
- 2.1 GB internal SCSI hard drive.....\$139
- Apple 12x internal CD-ROM.....\$99
- Apple 24x internal CD-ROM.....\$145

Upgrades

Logic board upgrade prices are with exchange.

- PowerMac G3 233mhz to G3 300mhz.....\$649
- PowerMac 7200/75 to 7600/120mhz.....\$489
- PowerMac 7200/90 to 7600/120mhz.....\$449
- PowerMac 7200/120 to 7600/132mhz.....\$399
- Quadra 610 to PowerMac 6100/60mhz.....\$275
- Quadra 660AV to PowerMac 6100/60mhz.....\$249
- Performa 600/11vx to PowerMac 7100/80.....\$349
- Quadra 650 to PowerMac 7100/80.....\$299
- Performa 6200 to 6500/225mhz.....\$499
- Performa 6300 to 6500/225mhz.....\$449
- Performa 6320 to 6500/225mhz.....\$425
- Performa 5200 to 5500/225mhz.....\$499
- Performa 630 series to 6200/75mhz.....\$275
- Performa 630 series to 6300/100mhz.....\$349
- Performa 630 series to 6360/160mhz.....\$499
- Math Coprocessor for Q605, Q610, P575, P630.....\$75
- Powerbook 190 series to 5300/100mhz.....\$399
- PB 520c/190cs/5300cs upgrade to active matrix...\$299
- Powerbook 1400cs upgrade to active matrix.....\$349

Visa/Mastercard/American Express No Surcharge.

Refurbished products have a 90 day warranty • Returns subject to a 15% restocking fee • Prices subject to change without notice.

Toll Free: 800-334-5494 International: 310-553-4507 Fax: 310-286-9667

Kiwi Computers, P.O. Box 67381, Los Angeles, CA 90067

Kiwi Computers is not an Apple Authorized Dealer. Mac, Power Mac, Performa, Powerbook, are trademarks of Apple Computer, Inc.

The Lowest Business Finance Rate Available

FREE Director V6.5 & PageMaker V6.5 w/Lease

- PowerPC G3/333MHZ or UMAX S900 G3 384MB/ 18GB RAID/ 32X CD /1MB L-2Cache
- IMS 128bit Twin-Turbo 1600x1200 w/8MB Graphic Engine & SONY 19" Color Display - Trinitron Tube.
- Agfa Arcus II w/ Transparency 36-bit Color Scanner w/ PhotoShop 5.0 & Calibration Software
- Wacom Tablet 12X12 w/ Painter V5, Epson Color 3000 17"X22" Color Proofer
- Combo Drive - JAZ, ZIP, 9GB, CD-R Dr. w/ UPS Battery Back-up & Active Terminator
- Image Solutions' Service contract, Loaner Program and Extended warranty.
- 0 Down Payment and No Payment for 90 days programs available. We work with 10 different banks. We shop the lowest leasing rate for you.

SUPERBUNDLE!

\$249
PER MONTH



MacroMedia - Director 5 - \$189 (MAC & Win.)

| | |
|---|-------------------|
| Authorware 3/Inte. Studio (10 / 20 Users) | \$489/\$689 |
| Authorware 4/Inte. Studio | \$789/\$1289 |
| BackStage / Studio | \$1529/\$2529 |
| Dreamweaver V1/V1.2 | \$149/\$199 |
| Director5/Multimedia Studio | \$199/\$269 |
| Director 5 (10/20) User | \$189/\$289 |
| Director 6 / 6.5 | \$489/\$789 |
| Director Multi. Studio 6/6.5 | \$499/\$589 |
| Design In Motion Suite: | \$689/\$849 |
| Fireworks / Shockwave | \$449 |
| Freehand 7/Graphics Studio | \$249/\$69 |
| Freehand 8/Graphics Studio | \$249/\$349 |
| Frontographer V4/ Bundle | \$289/\$389 |
| Flash V1/V2/V3 | \$249/\$299 |
| Macromedia xRes / Ex. 3D | \$149/\$199/\$269 |
| SoundEdit 16/ + DECK II | \$69/\$69 |
| | \$189/\$249 |

Microsoft - Office V4.2.1 - \$99(MAC & Win)

| | |
|-----------------------------|------------------|
| M.S. Office 4.2.1/Retail | \$169/\$249 |
| M.S. Office 97/Professional | \$289/\$329 |
| M.S. Office 98 / CD | \$349/\$249 |
| Microsoft Word V5/6/98 | \$99/\$199/\$269 |
| Excell V4/V5/98 | \$99/\$199/\$269 |
| Word 98 / Excell 98 | \$269/\$269 |
| M.S. Project V3/V4 | \$199/\$299 |
| FrontPage/Encyclopedia | \$99/\$49 |
| PowerPoint 4/ 98 | \$199/\$269 |
| M.S. Works V2/ V4 | \$59/\$95 |
| Windows 95/NT/98 | \$89/\$149/\$149 |
| NT Server V4 5/10 users | \$489/\$689 |

MetaCreation - Infini-D4 - \$349 (MAC & Win.)

| | |
|-----------------------------|-------------------|
| Bryce II/3D | \$99/\$159 |
| F.D. Detailer / Expression | \$249/\$169 |
| F.D. 3D STE/ RayDream 3D | \$329/\$85 |
| Dabbler II / Art Dabbler II | \$29/\$45 |
| Infini-D V4 / V4.5 | \$349/\$459 |
| Kai's Power Tool V2/3/SE | \$49/\$99/\$69 |
| PainterV3/4/5 | \$129/\$179/\$239 |
| Painter 3D/ Classic | \$269/\$95 |
| FD Poser v2/ V3 | \$99/\$159 |
| Logomotions V2.1/RayDream3D | \$85/\$95 |
| Ray Dream Studio / V5 | \$85/\$229 |

Corel - DRAW V8(MAC & WIN) - \$289

| | |
|--------------------------------|-----------|
| Corel Stock Photo/PhotoPaint | \$29/\$79 |
| HomePage V1/V3 | \$49/\$85 |
| WordPerfect V3.51 / Pro 8(WIN) | \$79/\$99 |

LaserSoft - SilverFast - \$129 (MAC & Win.)

| | |
|---------------------------------|-------------|
| SilverFast 3 Astra 610/1200 | \$129/\$189 |
| SilverFast Agfa Studio/Arcus II | \$249/\$499 |
| SilverFast 3 Epson 600/1200 | \$129/\$289 |
| SilverF. LinoType Jade/Saphir | \$139/\$439 |

Processor Upgrade

| | |
|--------------------|-------------|
| 604E 120MHZ/132MHZ | \$49/\$69 |
| 604E 150MHZ/180MHZ | \$99/\$119 |
| 604E 200MHZ/225MHZ | \$139/\$159 |
| 604E 233MHZ/400MHZ | \$169/\$289 |
| G3 233MHZ/250MHZ | \$385/\$635 |
| G3 275MHZ/300MHZ | \$779/\$979 |

Software Specials - MAC & Win.

| | |
|---|-------------------|
| Apple Mac OS 7.6/8/8.1 | \$49/\$59/\$79 |
| AppleShare V4/IP 5/IP 6 | \$289/389/489 |
| Apple PhotoFlash/Bundle CD | \$49/\$69 |
| ATM Deluxe/ Type Reunion Bundle | \$49/\$69 |
| Audiomedia III: PCI Audio I/OCard | \$689 |
| ACT!V2.8/ AfterEffect V3.1 | \$135/\$489 |
| Bundle CD:ClarisWork,FWB, NisusW | \$79 |
| Binuscan PhotoPerfect / Master | \$159/\$589 |
| CD Games/Color Access | \$9/\$79 |
| Canvas 5/ CD Creator | \$79/\$59 |
| Caere OmniPage Pro. V5/V8 | \$79/\$179 |
| Caere OmniPage Direct/LE | \$39/\$29 |
| Carere OmniForm V2/ ePaper | \$145/\$69 |
| Claris Bundle -FileMakerPro+Language Kits | \$289 |
| +EMail+Works+Impact+OS 8+ At Ease | \$289 |
| Claris Works V4/V5 | \$49/\$89 |
| CyberStudio V3/ Personal Edit. | \$279/\$89 |
| Conflict Catcher V3/V4 | \$29/\$55 |
| DOS Mounter '95/Here & Now | \$49/\$89 |
| Dantz Retrospect 4/ Remote | \$129/\$149 |
| DeBabelizer V3/FlashBack | \$299/\$35* |
| Extensis MaskPro/PowerSuite | \$269/\$169 |
| Extensis PhotoTools/PortFolio | \$179/\$89 |
| Extensis Intellihance/Pro Tools | \$89/\$689 |
| Extensis QX-Effects3/Tools2 | \$115/\$89 |
| Extensis Preflight Designer/Pro | \$59/\$329 |
| FWB H/D ToolKits PE / V2.5 | \$29/\$89 |
| FWB CD ToolKits V3 | \$39/\$298 Bundle |
| FileMaker Pro V4/V2.1 | \$149/\$79 |
| FrameMakerV5/FrameViewer | \$389/\$69 |
| FontFolio - Adobe V7.1/ Fonts | \$99/\$69 |
| FlightCheck/Final EffectAP | \$359/\$139 |
| HomePage V1/V2/V3 | \$29/\$49/\$89 |
| Language Kits/Chinese/Japanese | \$145 |
| Language Kits/Arabic/Cyrillic | \$69/\$69 |
| Live Picture 2.1/2.5/2.6.1 | \$99/\$129/\$179 |
| M.Y.O.B 7/NetScape Communi. | \$79/\$39 |
| NetObjects Fusion/ Now Utilities | \$69/\$49 |
| Norton Utilities V4/NisusWriter | \$85/\$49 |
| Pantone ColorDrive/ColorWeb | \$69/\$49 |
| Color Calibrator/ Color Chips | \$45/\$159 |
| Survivor /Color Dr. Bundle | \$159/\$189 |
| Pantone HexWrench/Guide | \$349/\$99 |
| PowerPrint /Persuasion V4 | \$89/\$199 |
| PC MACLAN Win95 / Pro | \$149/\$169* |
| QuarkExpress V3.3.2/4/Immedia | \$689/629 |
| Quicken V7/SE/Deluxe 98 | \$15/\$19/\$37* |
| Quicken Basic/ Surf Express | \$25/\$29 |
| RealPC / SpellCatcher | \$45 / \$39 |
| SAM V4/V4.5/V5 | \$29/\$45/\$65 |
| SpeedDoubler8/ShockWave | \$39/\$49 |
| SoftWindows 95/Try Ver. | \$179/\$39 |
| StrataStudioPro 2.1/ V2.5 | \$499/\$635 |
| SuitCase 3 / SpringClean | \$55/\$39 |
| StuffItDeluxeV3/V4.5 | \$35/\$55 |
| RAM Doubler II/Retrospect V3 | \$39/\$89 |
| Virex V5.8/ Virtual PC | \$58/\$45 |
| Vector Tools/ Effect | \$89/\$99 |
| VirusScan V3/VirtualPC | \$22/\$39 |
| WebPainter/ Web Buddy | \$59/\$35 |
| Web Star/ WordPerfect 3.51 | \$479/\$79 |
| Xerox TextBridge V3/Pro 8 | \$29/\$39 |

DIRECTOR 5 ONLY \$99 w/ \$1000 PURCHASE

DIRECTOR 6.5 \$539 w/ \$500 PURCHASE

Adobe Photoshop V3 - \$189 (Old Ver.)

| | |
|----------------------|---------------|
| Photoshop V3/V4 | \$189/\$289 |
| Illustrator V5/6/7 | \$149/199/289 |
| PageMaker V5/V6 | \$189/\$249 |
| Premiere V4/V4.2 | \$189/\$289 |
| Acrobat/StreamLineV4 | \$99/\$99 |

Ext. H/D, DAT Tape, MO, SyQ Dr.

| | |
|-------------------------------|-------------------|
| 42MB/230MB/1GB/2GB | \$69/99/149/179 |
| 2GB 7200rpm Ext. only | \$199 |
| Seagate 3GB Ext. only | \$229 |
| 4GB 7200rpm Ext. only | \$299 |
| 9GB 7200rpm Ext. only | \$449 |
| SONY DAT4000/5000/7000 | \$679/\$779/\$879 |
| SyJet 1.5GB Dr. w/2X cart. | \$385 |
| SyQuest 88C/200MB Ext. Drive | \$179/299 |
| SyQuest 105/270MB Ext. Drive | \$149/249 |
| SyQuest EZ135/ EZ230 | \$109/\$145 |
| SONY/Olympus 650MB M.O. Dr. | \$699 |
| IBM 650MB M.O. \$589 | |
| SONY 1.3GB/2.6GB M.O. Drive | \$989/\$1189 |
| Fujitsu 230/640 MB M.O. Drive | \$199/\$349 |
| Jaz ext. Dr. 1GB/2GB | \$169/\$289 |
| 1GB JAZ Ext. only | \$169 |
| JAZ+CD-R Ext. only | \$489 |
| 9GB+CD-R Ext. only | \$769 |

Scanner: Polaroid 35LE - \$739

| | |
|---------------------------|---------------|
| Epson 836/636 Expression | \$2449/\$689 |
| LinoColor JADEII / SAPHIR | \$445/\$1379 |
| ScanMaker III / V | \$1139/\$2349 |
| UMAX PowerLook III/300 | \$CALL/\$CALL |
| Agfa SnapScan / OuoScan | \$185/\$3179 |
| Nikon CoolScan / Super | \$875/\$1599 |

Digital Camera

| | |
|---------------------|--------|
| Agfa e-Photo 307 | \$339 |
| Canon PowerShot 350 | \$389 |
| Epson PhotoPC 600 | \$489 |
| Kodak D-120L 2MB | \$679 |
| Nikon CoolPix 900 | \$835 |
| Olympus D-500L2MB | \$785 |
| Olympus D-600L4MB | \$989 |
| Polaroid PDC-2000 | \$1469 |
| SONY MVC-FD5 | \$689 |

PAINTER V5 ONLY \$149 w/ \$500 PURCHASE

Monitor & Display

| | |
|----------------------|-------------|
| 15"/17" ColorMonitor | \$139/\$229 |
| (1280X1024, 0.26) | |
| 19"/20" ColorMonitor | \$469/\$589 |
| (1280X1024, 0.28) | |
| Iiyama 15"/17" | \$289/\$489 |
| Iiyama 19"/21" | \$689/\$889 |
| Optiquest 15"/17" | \$175/\$249 |
| Optiquest 19"/21" | \$489/\$789 |

AV & Display Card

| | |
|-------------------------------|-------------|
| Targa 2000 Pro - \$989 | |
| (Nubus) | |
| Targa 2000Pro -PCI | \$2889 |
| Targa 2000 - PCI | \$2289 |
| Targa 1000 - PCI | \$1489 |
| ATI XCLAM3D 4/8MB | \$179/\$239 |
| IMS 4MB/8MB 3D | \$235/\$369 |
| Image No.9 4M/8MB | \$329/\$589 |

Disk Array - RAID

| | |
|---|--------|
| (External w/Cable, Fan, RAID S/W, Terminator) | |
| 8GB SCSI II | \$489 |
| 8GB SCSI III F&W | \$589 |
| 12GB SCSI II | \$789 |
| 16GB SCSI II | \$889 |
| 16GB SCSI III F&W | \$1089 |
| 18GB SCSI II | \$989 |
| 18GB SCSI III F&W | \$1189 |
| 24GB SCSI II | \$1389 |
| 24GB SCSI III F&W | \$1489 |
| 36GB SCSI II | \$1589 |
| 36GB SCSI III F&W | \$1789 |
| 54GB SCSI II | \$2589 |
| 54GB SCSI III F&W | \$2789 |
| PCI SCSI F&W Card: | |
| (PCI UltraSCSI Differential Up to 80MByte per secon.) | |
| Adaptec REMUS | \$149 |
| Adaptec 2940UW | \$249 |
| Adaptec 3940UW | \$489 |
| ATTO Express PCI | \$329 |
| FWB JackHammer | \$349 |
| FWB RAID Tools | \$249 |

M.S. OFFICE 98 ONLY \$189 w/ \$1000 PURCHASE

Printers

| | |
|---------------------------|---------|
| Epson Stylus 3000\$Lowest | |
| Epson Stylus 1520 | \$649 |
| Epson Photo EX | \$489 |
| Epson Photo700 | \$275 |
| Epson Stylus 600 | \$239 |
| Epson Stylus 800 | \$295 |
| Apple 4/600 Laser | \$589* |
| Apple 12/600Color | \$2789* |
| Apple 16/600PS | \$1669 |
| Apple Laser8500 | \$1969 |

Graphic Tablets

| | |
|-------------------|-------|
| Calc 4X5/Painter | \$179 |
| Wacom 4X5/Painter | \$259 |
| Wacom 6X8/Painter | \$379 |
| Waco12X12/Painter | \$549 |
| Waco12X18/Painter | \$848 |

M.S. OFFICE V4.2.1 ONLY \$99 w/ \$500 PURCHASE

SyQuest

| | |
|-----------|-----------|
| 88/200MB | \$35/\$49 |
| 135/230 | \$14/\$23 |
| 1.5GB/270 | \$65/\$40 |

DAT Tape

| | |
|----------|---------|
| 60/90M | \$5/6 |
| 120M/170 | \$13/77 |

INFINI-D V4.5 ONLY \$399 w/ \$500 PURCHASE

| | |
|--------------------|-------------|
| 604E 120MHZ/132MHZ | \$49/\$69 |
| 604E 150MHZ/180MHZ | \$99/\$119 |
| 604E 200MHZ/225MHZ | \$139/\$159 |
| 604E 233MHZ/400MHZ | \$169/\$289 |
| G3 233MHZ/250MHZ | \$385/\$635 |
| G3 275MHZ/300MHZ | \$779/\$979 |

Iomega

| | |
|-----------|------|
| 1.0GB Jaz | \$78 |
| 100MB Zip | \$10 |

M.O. Disk

| | |
|-----------|---------|
| 128/230MB | \$6/9 |
| 650/1.3GB | \$29/38 |

FREEHAND 8 ONLY \$199 w/ \$1000 PURCHASE

Computers:

| | |
|--------------------|--------|
| G3 -233MHZ | \$1389 |
| G3 -266 DT | \$1589 |
| G3 -266 MT | \$1749 |
| G3 - 300 DT | \$1979 |
| 8600/300MHZ | \$1789 |
| 9600/200MHZ | \$1249 |
| 9600/G3 | \$1989 |
| 9600/400mhz | \$1679 |
| 9600/300MHZ | \$2289 |
| 9600/350MHZ | \$2579 |
| 7200/75MHZ | \$789 |
| 7300/180MHZ | \$1189 |
| 7350/180MHZ | \$1989 |
| 7300/200MHZ | \$1389 |
| MAC IICX | \$369 |
| Performa405 | \$249 |
| 8150 / WGS | \$1789 |
| 9150 / WGS | \$2089 |
| 9650/350MHZ | \$5289 |
| 500/WGS | \$Call |
| 700/WGS | \$Call |
| PF405 | \$189 |
| MAC IICX | \$349 |
| Q950/NuBus | \$689 |
| PM 6400/200 | \$889 |
| PM 6500/250 | \$1089 |
| PM 6500/275 | \$1189 |
| PM 6500/300 | \$1349 |
| PB1400CS/166 | \$1549 |
| PB3400C/200 | \$2449 |
| PBG3/233 | \$2249 |
| PBG3/266 | \$3649 |
| PBG3/292 | \$5169 |
| PowerTowerP \$1889 | |
| PowerTowerP/G3 | \$2489 |
| UMAX S900/200 | \$1089 |
| UMAX S900/G3 | \$1479 |

ADD \$179 FOR PHOTOSHOP V3 OR ILLUSTRATOR V5.5 w/SYSTEM

macally

| | |
|-------------------|-----------|
| Mouse/CASE | \$27/\$49 |
| Port Xpander - 3 | \$55 |
| Keyboard/w PAD | \$49/\$69 |
| Active Terminator | \$19 |

800-352-3410

385 Van Ness Ave. #110 • Torrance, CA 90501 Email: imagesol@earthlink.net

Fax: 310-782-5974
http://www.imagesolution.com

Image Solutions



Buy - Sell - Trade We Pay Top \$ for Your Old Computer! Call for an estimate.

Apple® PowerBook® G3 233MHz

- 32 MB SD-RAM Memory
- 2 GB IDE Drive
- 20xCD-ROM Drive
- Floppy Drive
- 14.1" TFT Active flat screen

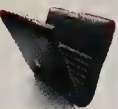
\$1,995 

iMac G3/233 MHz

- 64MB RAM ■ 4 GB Drive
- 24 x CD-ROM Drive
- 512K level 2 cache

\$1,185 

Power Macintosh® G3 300MHz AV Minitower

- 64 MB Memory/8 GB
- 24xCD-ROM Drive
- Int. 100MB Iomega Zip

\$2,149 

Apple® PowerBook® G3 266MHz

- 64 MB SD-RAM Memory
- 4 GB IDE Drive
- 20xCD-ROM Drive
- 56K Fax/Modem
- 14.1" TFT Active flat screen

\$2,975 

**hp HEWLETT®
PACKARD**

**Full Line of Printers,
and Parts Available.**

Power Macintosh® G3 266MHz Desktop

- 32 MB SD-RAM Memory
- 4 GB IDE Drive
- 24xCD-Rom Drive
- 512K level 2 backside cache

\$1,399 

Apple® PowerBook® G3 300MHz

- 64 MB SD-RAM Memory
- 8 GB IDE Drive
- DVD/VIDEO
- 56K Fax/Modem
- 14.1" TFT Active flat screen

\$4,545 

EPSON Stylus Color 740

Photo quality printing Inkjet printer

Support iMAC **\$269** 

Power Macintosh® G3 300MHz Desktop

- 64 MB Memory
- 6 GB Ultra Wide SCSI
- 24xCD-ROM Drive
- Internal 100 MB ZIP

\$1,799 

G3 333MHz Minitower

- 128 SDRAM MB Memory
- 9 GB Ultra Wide SCSI
- 24xCD-ROM Drive
- 6MB Video/1MB Cache, 16-bit Sound in-out

\$2,699 

Apple® PowerBook® 1400c/133*

\$1,095

- 32 MB RAM Memory ■ 1.3 GB Drive
- 8xCD-ROM Drive ■ 14.4 Fax/Modem ■ 11.3" TFT screen

macUniverse 

(818) 609-7012

macuniverse.com

sales@macuniverse.com

Fax(818)609-9435

Power Macintosh® 4400/200MHz

Desktop DOS PC/166

- 32 MB Memory ■ 2 GB HD ■ 256K Cache
- 12xCD-ROM Drive ■ Ethernet

\$799 

Best Deals on all CALL Now!

Printers/Scanners/Displays
Digital Cameras/Software/Games!

Best Deals on all CALL Now!

USB Port Products 

19100 Ventura Blvd., Tarzana, CA, 91356

Digital Reality, Specializing in Rebuilt Imagesetters complete PrePress Systems & Digital Video

www.DigitalReality.net
email:CLucero126@aol.com

phone 949- 574-3939
fax 949- 574-3947

3101 W.PCH suite 150 Newport Beach Ca. 92663

SilkScreening

Imagesetter - Agfo or LinoType 18" Wide

- Includes RIP
- Adobe Postscript
- 2400 DPI
- Factory Refurbished

\$15,500 

Pre Press System

Complete Color Pre Press System

Includes Power Mac G3 32/16, 17" Color Monitor, Software, Ex Keybd., AGFA Color Scanner, Color Proof Printer, Imagesetter w/Rip Processor.

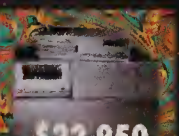
\$22,950 

Harlequin Rip

Mac & Windows

Only Two In Stock!

\$5695

Dolev System

SCITEX DOLEV 400/ 4UP IMAGESETTER WITH PSM SOFTWARE RIP

FACTORY REFURBISHED \$40,000. INCLUDES 6 MONTH FULL WARRANTY INSTALLATION, DELIVERY AND TRAINING!!

\$40,000 

Spot Color System

COMPLETE SYSTEM FOR SPOT COLOR

Includes Power Mac, software, DyeSub color Printer, AGFA Imagesetter, and Densitometer.

\$17,950 

PlateMaking System

Digital Plotmaking Refurbished System

Includes AGFA Imagesetter for process color, separations upto 150 lines/screen, Rebuilt plate processor, densitometer, postscript II Rip, Calibration software

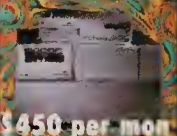
\$450 per month 

Scanner

D4000

- 3.8d Optical
- User Slectable
- 600 RPM
- Tungsten Light
- Focus control

Bringing high quality color scanning to mid-range publishing print shop

\$9,950 

ECRM MAKO

The best Imagesetter available with Punch Registration:

Mako 3600 14" Harlequin Rip G3 300MHZ Processor Densometer

\$1275 Per Month 

ECRM Marlin

Marlin: 18.1", Harlequin Rip, G3/300 MHZ, Processor, Densometer! **\$1875 Per Month**

KnockOut 

SAPHIR SCANNER

High quality color scanner Lino Color light why pay \$4,500 for a high quality sanner when you can purchase a refurbished one!

\$945 

AVID® XPRESS

XPRESS Workstation for Macintosh

SYSTEM INCLUDES:
Real Time effects, country kit 110v, betacam video, avid standards effects, Single Channel Controller 2

Call!



AVID® XPRESS

XPRESS Elite Bundle Workstation

SYSTEM INCLUDES:
Real Time effects, country kit 110v, betacom video, avid standards eAudio, 3D realtime 8500 free software

Call!



Media 100LX

9500/200MHz 128MB/2G/CD

After Effects 3.0, 17" Monitor, Keyboard, 4100 w/SCSI Wide Array, Vicent Component, Botch

demo unit 10,000 

Scitex Station

PM 9500/200/128MB/3GB/CD/ATI

Edit on the first in dual channel realtime all the time system. Do Superbowl effects! ESPN effects w/ Devious effects and advance effects.

Complete system for only **demo unit 14,795**



TARGA 2000 RTX

SDX and Madras

Call!



New & factory refurbished. Call for special government and educational discounts. We purchase used imagesetters call for bids



www.icni.com

For Our Most Current Prices Please Visit Our Web Site

WIDER MACINTOSH MODELS, TOSHIBA NOTEBOOKS, IBM, COMPAQ, PARTS



PowerBook Hard Drive
500MB, 750MB, 1GB
\$99, \$119, 149

PowerBook 5300c
Active Screen/100MHz/16/750HD
\$729*

Apple Monitor 15" AV
Multi Scan **\$249***

PowerMac 7600
132MHz/16/1GB/CD
\$729*

PowerMac 8500
120MHz/16/1GB/CD/KB
\$795*

Apple Monitor 17"
750 Vision **\$389***

Apple Laserwriter 8500
600DPI/20PPM
\$1595*

PowerBook 1400cs
117MHz/12RAM/750HD
\$895*

POWERMACS G3

| | | |
|--------|--------------------------|-------------|
| G3/333 | 128MB/UW9GB/24XCD/KB |\$2799 |
| G3/300 | 64MB/8GB/24XCD/KB/Zip/AV | ...\$2279 |
| G3/300 | 64MB/6GB/24XCD/KB/Zip |\$1899 |
| G3/266 | 32MB/4GB/24XCD/KB |\$1543 |

RECONDITIONED POWER MACS

| | | | |
|------|---------|-------------------------|-------------|
| 9500 | 233Mhz | 16/2GB/CD/VC/KB |\$1195 |
| 9500 | 200 MP | 32/2GB/CD/VC/KB |\$1295 |
| 9500 | 132Mhz | 16/1GB/CD/VC/KB |\$1095 |
| 8600 | 250 Mhz | 32/4GB/24xCD/Zip/KB |\$1690 |
| 8600 | 200 Mhz | 32/2GB/12xCD/Zip/KB |\$1390 |
| 8500 | 180Mhz | 16/1GB/CD/KB |\$939 |
| 8500 | 132Mhz | 16/1GB/CD/KB |\$859 |
| 7600 | 132 Mhz | 16/1GB/CD/KB |\$739 |
| 7500 | 100 Mhz | 16/1GB/CD/KB |\$695 |
| 7300 | 180 Mhz | 16/2GB/12xCD/KB |\$1049 |
| 7200 | 120 Mhz | 16/1GB/CD/KB |\$659 |
| 7200 | 90Mhz | 8/500MB/CD/KB |\$599 |
| 6500 | 275Mhz | 32/6GB/24XCD/KB/MOD | ...\$1095 |
| 6500 | 250Mhz | 32/4GB/24XCD/KB/MOD |\$995 |
| 6500 | 225Mhz | 32/3GB/12XCD/KB/MOD |\$879 |
| 5500 | 225Mhz | 32/2GB/ETH/24XCD/Mon15" | ..\$1195 |
| 4400 | 200Mhz | 32/2GB/12XCD/KB |\$779 |

POWERBOOK G3

| | | |
|--------|------------------------------------|----------|
| G3/292 | 64MB/8GB/20XCD/56K/ETH/14.1"A/FLOP |Call |
| G3/266 | 64MB/4GB/20XCD/56K/ETH/14.1"A | ..\$3279 |
| G3/250 | 32MB/4GB/20XCD/56K/ETH/13.1"A/FLOP |Call |
| G3/233 | 32MB/2GB/20XCD/56K/ETH/14.1"A | ..\$2695 |
| G3/233 | 32MB/2GB/20XCD/56K/ETH/12.1"P/FLOP | ..\$2095 |

RECONDITIONED POWERBOOKS & DUOS

| | | | |
|---------------|-----------|----------------------|-------------|
| 3400c | 240Mhz | 16/3GB/12XCD/Mod/ETH |\$1790 |
| 3400c | 200Mhz | 16/2GB/6XCD/Mod/ETH |\$1729 |
| 3400c | 180Mhz | 16/1GB/6XCD |\$1479 |
| 1400cs | 166Mhz | 16/1GB/12xCD |\$1395 |
| 1400c | 133Mhz | 16/1GB/8xCD |\$1279 |
| 1400cs | 117Mhz | 12/750MB |\$899 |
| 5300ce | 117Mhz | 32/1GB |\$929 |
| 5300c | 100Mhz | 16/750MB |\$729 |
| 5300cs | 100Mhz | 8/500MB |\$695 |
| 540c | 33Mhz | 4MB/320MB/Mod |\$579 |
| 520c | 33Mhz | 4MB/160MB/Mod |\$479 |
| 180c | 4MB/160MB | |\$379 |
| 170 | 4MB/120MB | |\$285 |
| DUO 2300c | 100Mhz | 8MB/750MB/Mod |\$749 |
| DUO 280c | 33Mhz | 4MB/120MB/Mod |\$369 |
| DUO Dock Plus | | |\$169 |

RECONDITIONED PERFORMAS

| | | |
|------|---------------------------|------------|
| 6400 | 180MHz/16/1.6GB/Mod/CD/KB |\$729 |
| 6360 | 160MHz/16/1GB/Mod/CD/KB |\$695 |
| 5400 | 180MHz/16/1GB/CD/Mon 15" |\$995 |
| 5200 | 75MHz/8/500MB/CD/Mon 14" |\$695 |

UPGRADES

With ORIGINAL APPLE LOGIC BOARD

PM 8500 LOGIC BOARD UPGRADE
FROM Q800, Q840AV, PM 8100 TO 8500 **\$769**

PM 7600 LOGIC BOARD UPGRADE
FROM PM 7200 TO 7600 **\$489**

DUO UPGRADE 200 Series To 2300 **\$449**

200/233MHz Processor Upgrade **\$135/\$179**

132MHz/180MHz Processor Upgrade **\$39/\$109**

UPGRADE YOUR POWERMAC To G3 As Low As \$449

6100,7100,8100 To G3 215-225MHz Sonnet **\$439**

6100,7100,8100 To G3 240-250MHz Sonnet **\$589**

6100,7100,8100 To G3 257-266MHz Sonnet **\$690**

7300 Through 9600 To G3 233MHz Sonnet **\$395**

7300 Through 9600 To G3 266MHz Sonnet **\$649**

7300 Through 9600 To G3 300MHz Sonnet **\$795**

CD RECORDERS By Fantom

YAMAHA 400AT 4xCD (Ext) **\$439**

YAMAHA 4x2x6 CD Rewritable (Ext) **\$459**

Panasonic 4x8 CD (Ext) **\$359**

Carravelle 8x20 CD (Ext) **\$869**

Ricoh 2x2x6 CD Rewritable(Ext) **\$379**

Processor Card

200MHz/640e **\$135**

1.800.472.4921

Fax: (310) 445-6611 Tel: (310) 445-6600

FAX TOLL FREE FROM JAPAN: 00-31-114211

11755 Exposition Blvd., Los Angeles CA 90064

MONITORS

APPLE VISION 850 AV 20" **\$1179**

APPLE VISION 850 20" **\$995***

APPLE 20" Mult Display **\$690***

APPLE VISION 750 17" **\$389***

APPLE 15" AV Multi **\$249***

APPLE Multi Scan 14" **\$155**

APPLE RGB 13" **\$99***

NEC E500/E700 **\$269-589**

NEC 21" P1250/E1100 **\$1089-1059**

SONY 15" 100ES/15" 100GS **\$239-279**

SONY 17" 200ES/17" 200GS **\$395-489**

SONY 21" 500PS/19" 400PS **\$1195-795**

VIEWSONIC 15"E655/G653 **\$219-235**

VIEWSONIC 17" GS771/E771 **\$369-339**

VIEWSONIC 20" P810/P815 **\$1049-1195**

OPTIQUEST 15" Q53-V55 **\$185/195**

OPTIQUEST 17" V775-V773 **\$399/\$345**

OPTIQUEST 20" Q100/19" V95 **\$889-449**

HITACHI CM 500 15"/CM 620 17" **\$249-389**

HITACHI CM 751 19"/CM 800 21" **\$649-889**

HITACHI MC 801 21"/MC 801HR21" **\$1079-1295**

PRINTERS

APPLE LaserWriter 12/640PS **\$769***

APPLE LaserWriter 16/600 **\$899***

APPLE LaserWriter IINT **\$249***

APPLE LaserWriter 8500 **\$1595**

APPLE LaserWriter 2500 **\$229***

APPLE Color StyleWriter 4100 **\$229***

APPLE Color StyleWriter 4500 **\$239***

EPSON STYLUS 800 **\$239**

HP LASER JET 6 LXI **\$385**

HP LASER JET 4000 N **\$1399**

HP LASER JET 4000 TN **\$1549**

STORAGE & MEDIA

OMEGA JAZZ 2GB DRIVE Ext. **\$299**

OMEGA JAZZ 2GB Cartridges **\$87**

OMEGA ZIP Drive 100MB Int. **\$98**

OMEGA ZIP Cartridges 100MB **\$8.5**

VST ZIP Drive 100MB For PowerBook G3 **\$219**

Prices Subject to Change Without Notice • All Prices reflect 3% Cash Discount • * Refurbished
ICN Is Not An Authorized Apple Dealer • All Trademarks Are Property Of Their Respective Companies.

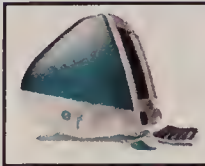

PowerMacs

iMAC \$1145

G3/233, 32, 4GB, 24xCD, 15" AV Display

- G3/333 Minitower 128/9GB UW, 24xCD \$2545
- G3/300AV Mntwr. 128/9GB UW, CD, Zip \$2545
- G3/300AV Minitower 64/8GB, 24xCD, Zip \$1999
- G3/300 Desktop 64/6GB, 24xCD, Zip \$1595
- G3/300 Desktop 32/4GB, DVD/Video \$1795
- G3/266 Desktop 32/4GB, 24xCD \$1399
- 9600/200MP, 9600/300 & 9600/350 CALL
- 8600/200 64-2GB, 12xCD, Zip \$1275
- 4400/200DOS 32/2GB, 12xCD, 256K \$775
- PC/166 DOS Card 16MB, Win 95, Dos 6.22 \$195

Apple Displays & Printers

- 720 17" \$395 LaserWriter 16/600PS \$1195
- 1705 17" \$355 LaserWriter 16/600PS \$945*
- 1710* 17" \$355* LaserWriter 12/640PS \$745*
- ColorSync 20" \$1399 LaserWriter 4/600PS \$535*



All ArtZ Tablets Include Pentools.
All Intuos Tablets Include Painter Classic.

- Intuos 4x5/6x8/9x12/12x12 \$159/289/399
- Intuos 12x18 \$699
- ArtPad 4x5/ ArtZ 6x8/6x8* \$99/249/189
- ArtZ 12x12/12x12*/12x18* \$349/289/385
- ArtZ 12x18 Electrostatic* \$439



Visit Our Sites or
Call Us for Full List of
Products & Parts
on PC Systems

TOSHIBA

www.toshibadeals.com



www.ibmdeals.com

COMPAQ

www.compaqdeals.com



PowerBooks

G3/300 \$4399

64/8GB, DVD/Video, 56K Fax, 14.1

- G3/292 64/8GB, 20xCD, 56K \$3795
- G3/266 64-4GB, CD, 56K, 14.1" TFT \$2795
- G3/250 64-4GB, CD, 56K, 13.3" TFT \$2395
- G3/233 64-2GB, CD, 56K, 14.1" TFT \$1995
- G3/233 64-2GB, CD, 14.1" TFT \$2195
- G3/233 64-2GB, CD, 12.1" TFT \$1795
- 3400C/240 & 3400C/200 \$1595/1385
- 3400C/180 32-1.3GB, 6xCD, 33.6 \$1395
- 1400C/133 32-1.3GB, 8xCD \$1095
- 5300CS/100 32-500MB, W/Free Battery \$685
- DUO 2300C/100 16-1.1GB \$775
- Floppy + Adap. for Duo \$165



**HEWLETT
PACKARD**

Printers LaserJets

- 8000N/5000N 1200dpi, 11x17" \$2545/1939
- 4000N/TN 17ppm \$1289/1389
- 4000N*/4000TN* \$1175/1275
- 5M/5M*/6MP* \$1225/1175/685
- DeskJet 1600CM/1600CM* \$1175/995
- 4MV/4MV*/5SIMX \$1295/1095/2349

6MP 8ppm, 3MB, 600DPI, PSL2 \$745

XEROX DocuPrint Laser Printers CALL

Trade-in Your **Old Mac**
for a **New One!**
Call for an estimate.
(818)609-0466



**UNIVERSAL
Computers, Inc.**

Von Nuys, CA, USA

Apple, MAC, iMac, PowerMac, PowerBOOK, are registered trade marks of Apple Computers, Inc.

Prices are based on C.O.D. Order & subject to prior sales & change!

www.computerstogo.com

e-mail: usales@universalcomputers.com



MWAd#

0199

Sales: 1-800-621-1963

Sales: (818) 786-8150

FAX: (818) 787-2111

www.datamicro.com

e-mail: datamicro@earthlink.com

1-800-345-1234

- G3/333MT 128/9GB/24xCD... \$2599
- G3/300DT 64/6GB/24xCD/Zip... \$1699
- G3/266MT 32/6GB/24xCD/Zip... \$1645
- G3/266DT 32/4GB/24xCD... \$1325
- G3/233MT 32/4GB/24xCD/56K... \$1499
- G3/233DT 32/4GB/24xCD... \$1245
- 9600/350/300 & 8600/350/300 CALL
- 7300/200 32/4GB/CD... \$975*
- 6400/200 16/2.4GB/CD/Modem... \$779
- 5200/75 8/800MB/4xCD... \$549

Performa 6400/200 16/2.4GB/CD/Mdm.
Apple Multiple Scan 15AV

Epson Stylus ProXL 11x17* **\$1289**

PowerBooks

Discount Prices

- G3/300 64/8GB/DVD/56K/14.1" ... \$4395
- G3/266 64/4GB/56K/14.1" ... \$2945
- G3/233 32/2GB/20xCD/56K/14.1" ... \$2395
- 3400C/240 16/3GB/CD/Modem... \$1675*
- 3400C/200 16/2GB/CD/Modem... \$1495*
- 3400C/180 16/1.3GB/CD/Modem... \$1345*
- Duo Dock... \$75
- 5300c and CS 8/750MB... \$725*/625*

Fax: (310) 391-2488

International: (310) 398-3300

Displays, Printers & Scanners

- Apple Multiple Scan 14"/15"AV/1705*/1720*... \$199/295/379/425
- ViewSonic V73/G773/G790 Color Monitors... \$349/399/595
- KDS 15"/17"/21" Color Monitors... \$189/299/769
- EPSON Stylus ProXL Photo Quality 720x720, 11"x17" Printer... \$289

**We Carry all Line of Agfa/UMAX/EPSON/HP HEWLETT
Printers & Scanners. Call for Super Bargain Deals!**

Apple, Performa, PowerBook, & DuoDock are registered trade marks of Apple Computers, Inc.
*Reflects Factory Refurbished Units. Schools & Gov. Agencies P. O.'s accepted.

TRADE YOUR MAC FOR A NEW ONE. We Pay Top \$\$\$ For Your Mac & Mem.

CALL FOR UPGRADES
Email: cgn@cgnusa.com

We custom configure
and test your system.

PowerMacs

- G3 266 Mhz 32/4gb/CD 1395
- G3 233 Mhz 32/4gb/CD 1280
- G3 300 Mhz 64/4gb/CD 1875
- 9600 300 Mhz Call
- 8600 300 32-4Gb-CD 1420
- G3 300 MT AV 1959
- G3 266 MT AV 1695

WoW !! iMAC in Stock

- G3 333 Mhz 3195
- 7200 /75/90/120 CALL
- Call for config. not listed

Powerbooks

- G3 292 Mhz DVD 4750
- G3 292 Mhz 14" 3795
- G3 266 Mhz 2950
- 1400C 117 Mhz 1095
- 3400cs 240 Mhz 1585

G3 Power Books Call

Demo Powerbooks

- 1400CS 16/2gb/cd 1090
- 540C 12/500/Mod 625
- 5300c 16/750 875
- 145 - 170 -180c-165c CALL
- 5300 c 16/750 895

Upgrades

- Same day Upgrade No down Time!!
- Prf 63X to 6300 6-100Mhz 390
- 7200 to 7600 399
- 8100 to 8500 499
- 7500 to G3 250 Mhz 635
- CALL for G3 Upgrades !!!
- Q800- Q840 to 8500 599
- 9600 to G3 300Mhz Call
- Quadra to 7500/100 329
- Q800-840 to 8100 349
- Call for PowerBook Upg.
- Call for Upgrades not listed

Demo Macs

- 8500 32-2gb-cd 795
- 7600 695
- 8600 1090
- 8100 16/500/CD 590
- Q 650 16/120 150
- 6100 16/250 300
- SE 30 99
- Mac IIfx 65

Special

- 8500 32/2gb cd \$795
- Q650 16/120 \$150
- 7600 32/1gb/CD \$690

Storage

- Dimms 32/64/128 55/89/179
- 30 Pin 1/4/16 8/13/55
- 72 Pin 16/32 45/75
- CD 2X-4X-12X-24X Call
- HD 1.GB - 2.GB-4GB Call
- lomega Jazz Drive 2GB 329
- Global Village Modem 149

Call For:

Monitors, Printers, Scanners.
All Apple Parts In Stock and
We do Advance exchange.
Leasing Available.

Parts

- Floppy 1.44 65
- POWER SUPPLIES CALL
- AV Card \$175
- Power supply Cx Ci 7100 45
- Call for Logic Boards & more

Computer Graphics & Networking

All prices Reflect cash Discount
Visa, Mastercard, Amex Accepted
<< Prices are subject to Change.>>

TEL: 310-441-4771 10922 W. Pico Blvd. Los Angeles, CA 90064 Fax: 310-441-4770

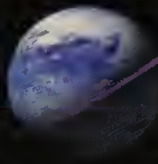

Open Monday-Friday: 9am-8pm & Saturday: 10am-5pm CST E-Mail Us at: owc@macsales.com



Other World Computing

SERVING THE MAC UNIVERSE SINCE 1988

On Web Commerce
Other World Computing has Easy, Fast, Secure Internet Ordering Now.

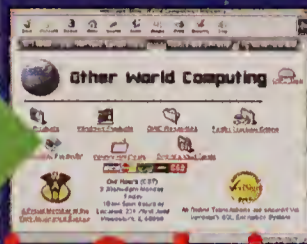

Other World Computing means Competitive Prices, Quality Products and NEVER a Surcharge for Credit Cards!



800-275-4576

FAST! EASY! SECURE!

Apple ROM 1.2 Gig Quantum Fireball

- SCSI
- 9.5ms
- 1 Year Warranty



\$99 Internal
External: **\$149**

FWB HD Tool Kit v2.5.x
Included with all Hard Drives
30 Day Money Back Guarantee
Full Manufacturer Warranty

HardDrives Include
30MB OF FREE SOFTWARE INSTALLED. EXTERNAL VERSION FEATURES PLATINUM CASE WITH DUAL SCSI PORTS, PUSH-BUTTON SCSI ID AND 40 WATT POWER.

SCSI hard drives

Int. Ext.

| QUANTUM | | | |
|--------------------|---|---------|---------|
| 9.1gb Atlas II | QM39100AL 8ms 7200rpm 1024k 5yr AV | \$439 | \$489 |
| 18.2gb Atlas III | QM318200TDS 7.8ms 7200rpm 1024k 5yr | \$1099 | \$1159 |
| SEAGATE | | | |
| 2.15gb Barracuda | ST32550WC 8ms 7200rpm 512k Cache 5yr | \$149 | \$199 |
| 4.5gb Medalist Pro | ST34520N 9.5ms 7200rpm 512k Cache 3yr | \$289 | \$339 |
| 4.5gb Cheetah | ST34501N 8ms 10,000rpm 1024k Cache 5yr | \$369 | \$439 |
| 6.5gb Medalist Pro | ST36530N 9.5ms 7200rpm 512k Cache 3yr | \$399 | \$449 |
| 9.1gb Medalist Pro | ST39140N 9.5ms 7200rpm 512k Cache 3yr | \$499 | \$549 |
| 9.1gb Barracuda | ST39173N 9.5ms 7200rpm 1024k Cache 3yr | \$579 | \$629 |
| 18gb Barracuda | ST118273N 9.5ms 7200rpm 1024k Cache 5yr | \$1,099 | \$1,159 |

Call or Visit www.macsales.com for other IBM, Seagate, & Quantum UltraNarrow and UltraWide SCSI Drives

All Processor Cards, Cache & Accelerators include an Other World 30 Day Satisfaction Guarantee.

MORE POWER FOR NUBUS OR PCI PowerMacs!



Put a new G3 into your older PowerMac and experience the G3 difference!

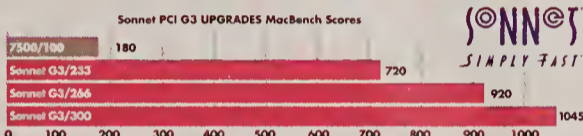

Sonnnet PCI G3 Upgrades For the PowerMac 7300/7500/7600/8500/8515/8600/9500/9515/9600, Workgroup Server 7350, 8550, 9650, Power Comp., PowerWave, UMAX J700 & S900; and DayStar Genesis 538.

- G3-233mhz** w/512k 2:1 Backside Cache... **\$339**
- G3-266mhz** w/1024k 2:1 Backside Cache... **\$569**
- G3-300mhz** w/1024k 2:1 Backside Cache... **\$759**
- G3-333mhz** w/1024k 2:1 Backside Cache... **\$895**
- G3-366mhz** w/1024k 2:1 Backside Cache... **\$1129**
- G3-400mhz** w/1024k 2:1 Backside Cache... **\$CALL**

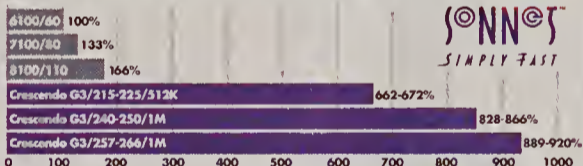

Sonnnet Crescendo Nubus G3 Upgrades For the PowerMac 6100/7100/ 8100 & 8115; Performo 6110/6112/6115/6116/6117/6118; Workgroup Server 6150/8150/9150; Radius 81/110.

- G3-225mhz** w/512k 2:1 Backside Cache... **\$419**
- G3-250mhz** w/1024k 2:1 Backside Cache... **\$599**
- G3-266mhz** w/1024k 2:1 Backside Cache... **\$679**
- G3-300mhz** w/1024k 2:1 Backside Cache... **\$799**

XLR8 Adjustable G3 Upgrades For the PowerMac 7300/7500/7600/8500/8515/8600/9500/9515/9600; Workgroup Server 7350, 8550, 9650; Power Computing PowerCenter, PowerCurve, PowerWave, PowerTower; UMAX J700 & S900; and DayStar Genesis 538.

- G3-220mhz** w/512k 2:1 Backside Cache... **\$369**
- G3-233mhz** w/512k 2:1 Backside Cache... **\$389**
- G3-266mhz** w/512k 2:1 Backside Cache... **\$529**
- G3-300mhz** w/512k 2:1 Backside Cache... **\$669**
- G3-300mhz** w/1mb 2:3 Backside Cache... **\$859**
- G3-333mhz** w/1mb 2:1 Backside Cache... **\$1169**
- G3-366mhz** w/1mb 2:1 Backside Cache... **\$1359**
- G3-400mhz** w/1mb 2:1 Backside Cache... **\$1649**

Level 2 Cache

| | 256k | 512k | 1Mb |
|--------------------------------------|------|------|-------|
| 6100 PowerMacs/Performas | \$15 | | |
| 7100/8100 PowerMacs/Performas | \$15 | | \$99 |
| 73/75/76/85/8600 & Compatible Clones | \$69 | | \$119 |
| 6360/6400/6500; Starmax; & PowerBase | \$49 | | \$169 |

OWC OnLine Ordering Is OnLine Now
www.macsales.com

- 24HR. ONLINE ORDERING & PRODUCT INFO
- DAILY UPDATED PRICES & SPECIALS

School/University/Government/Corporate Purchase Orders Gladly Accepted (SUBJECT TO CREDIT APPROVAL)

GET THE DETAILS ON ACCELERATING YOUR MAC ON OUR WEBSITE AT:
www.fastermacs.com

Mac Memory Products

Memory listed by OWC is New with Lifetime Warranty and 30 Day Money Back Guarantee. All Memory products meet or exceed Apple Specifications.



- 30 PIN SIMMS** Non-Parity for Older Macs
- 4 MEGABYTE** 70 or 60 NanoSeconds... **\$15**
- 16 MEGABYTE** 70 or 60 NanoSeconds... **\$45**

- 72 PIN SIMMS** 2k Refresh 60ns
- 8MEG** \$19 **16MEG** \$33 **32MEG** \$65



- 168 PIN DIMMS** 2k Refresh 70 or 60ns (specify)
- 16 MEGABYTE** **\$35** **EDO 5V** **\$29** **EDO 3.3V** **\$29**
- 32 MEGABYTE** **\$59** **\$55** **\$59**
- 64 MEGABYTE** **\$115** **\$105** **\$119**
- 128 MEGABYTE** **\$259** **\$259** **N/A**

- 10ns SDRAM** for G3 DeskTops and MiniTowers
- 32 MEGABYTE** **\$49**
- 64 MEGABYTE** **\$99**
- 128 MEGABYTE** **\$189**
- 256 MEGABYTE** **\$489**

- WallStreet & iMac G3 Computers Memory**
 - 32 MEGABYTE** **\$59**
 - 64 MEGABYTE** **\$105**
 - 128 MEGABYTE** **\$189**
- Call for PowerBook 190/500/1400/5300/3400/3500 and Duo Series Memory

- Video Ram Memory Upgrades**
- 256k PMac 7100/Quadra800/650** **\$12**
- 512k PMac 8100/Quadra's/LC's** **\$15**
- 1MEG PMac 72/73/75/76/85/8600 & Compat.** **\$19**
- 4 MEG Motorola StarMax/PowerMac 4400** **\$19**
- 4 MEG G3 Video SGRAM** **SPECIAL! \$29**

OWC is a Techworks Authorized Reseller. Call or Visit www.macsales.com for the best prices on Techworks Brand Memory. **TECHWORKS** Power To Perform

Other World Computing
224 West Judd St., Woodstock, IL 60098
International: (815) 338-8685
Fax: (815) 338-4332

3.2 Gig IDE Quantum Fireball EX

\$149 Internal Int.
• 5400 rpm
• 9.5ms
• 3 Yr. Warr.
QM303200EXA

| QUANTUM | | | |
|--------------------|---|-------|--|
| 6.4Gb Fireball EX | QM306400EXA IDE 5400rpm 3.5" 9.5ms with 3yr warr | \$209 | |
| 12.7Gb Fireball EX | QM312700EXA IDE 5400rpm 3.5" 9.5ms with 3yr warr | \$379 | |
| IBM | | | |
| 8.4Gb Deskstar | IBM00K0394 IDE 5400rpm 3.5" 9.5ms with 3yr warranty | \$259 | |
| 10.1Gb Deskstar GP | IBM00K4091 IDE 5400rpm 3.5" 9.5ms with 3yr warr | \$299 | |
| 12.9Gb Deskstar GP | IBM00K4083 IDE 5400rpm 3.5" 9.5ms with 3yr warr | \$399 | |
| 16.8Gb Deskstar GP | IBM00K4073 IDE 5400rpm 3.5" 9.5ms with 3yr warr | \$479 | |

Maxtor & Seagate also in Stock!

10 for \$89 Zip Disks

Removable Storage

| | Int. | Ext. |
|--|------------------|------------------------------|
| Iomega Zip 100MB SCSI With 1 Cartridge | \$109 | \$99 |
| Iomega Zip Plus External With 1 Cartridge | HOT DEAL! | \$155 |
| Iomega Jaz 1GIG SCSI With 1 Cartridge | \$219 | \$289 |
| Iomega Jaz 2GIG SCSI With 1 Cartridge | \$309 | \$339 |
| Iomega Zip Cartridges \$11 each Jaz 1Gb Cartridges \$79 each. | | |
| Iomega Zip Cartridges 10 for \$89 Jaz 2Gb Cartridges \$85 each. | | |
| Panasonic CDR 4x8 with Toast & Media | | \$379 |
| Yamaha CDRW4260 | | \$449 |
| 2X CD ReWritable/4X Recordable/6X Read w/1 cdr, 1 cdrw, Toast 3.5 | | |
| Verbatim 74 Minute Gold CDR Media w/Jewel Case | \$225 ea. | 50 for \$99 100 for \$185 |

HOT BUYS ON POWERBOOK SCSI and IDE HARD DRIVES

SCSI PowerBook hard drives
for PowerBook 100 series (except 150), 520/540(c), & Duo Series (except 2300)

| IDE PowerBook hard drives | Int. |
|--|--------------|
| for PowerBook 150/190(cs)/5300/1400/3400 Series | |
| 4.0GB IBM Travelstor 4200rpm 12mm Slim with 3 Year Warranty | \$319 |
| 5.4GB IBM Travelstor 4200rpm 12mm Slim with 3 Year Warranty | \$389 |
| 6.4GB IBM Travelstor 4200rpm 12mm Slim with 3 Year Warranty | \$449 |
| 8.4GB IBM Travelstor 4200rpm 12mm Slim with 3 Year Warranty | \$629 |



Prices and specifications subject to change w/o notice. 15% restocking fee applicable for all returned merchandise unless noted otherwise. Returns not accepted without return authorization number.

SHREVE Systems

For all this and more check out our website!

<http://www.shrevesystems.com>



WE BUY MACS & MAC STUFF (318) 424-9791
WE STOCK MAC PARTS!
1-800-227-3971

FAX (318) 424.9771 • Technical Support (318) 424.7987
 Customer Service (318) 424.9791 • Purchasing/Information (318) 424.9791
 1200 Marshall Street • Shreveport, Louisiana 71101

PowerMac 5400/180
 • 16MB of RAM
 • 1.6GB Hard Drive **PowerPC**
 • 8X CD-ROM
 • 180-MHz PowerPC 603e
 • Refurbished **\$899**

PowerMac 6500/250
 • 32MB of RAM
 • Iomega ZIP™ Drive **zip 100**
 • 4GB Hard Drive **PowerPC**
 • 12X CD-ROM
 • 250-MHz PowerPC 603e
 • Refurbished **\$979**

PowerBook 5300cs
 • 100-MHz 603e
 • 16MB of RAM
 • 750MB HD
 • Dual-scan color
 • Refurbished



FREE!! ClarisWorks 3 and Carrying Case!
ADD VIKING™ V.90 PC CARD MODEM FOR \$100!

Macintosh LC580

• 33-MHz MC68LC040
 • Built-in display **\$649**
 • 8MB of RAM
 • 800MB Hard Drive
 • Includes mouse and keyboard
FREE software!
\$749 with internal 4XCD



PowerMac Upgrades

Quadra/Centris 610 to PowerMac 6100/60 (refurbished)
As low as \$299!
 with exchange of your working board

Quadra/Centris 650 to PowerMac 7100/80 Upgrade (refurbished)
As low as \$349!
 with exchange of your working board

Quadra 800/840av to PowerMac 8100/80 (refurbished)
As low as \$299!
 with exchange of your working board

Performa 630 to PowerMac 6300/120 (refurbished)
As low as \$399!
 with exchange of your working board

Wow!
 Performa 6200/75 180-MHz Upgrade (refurbished)
As low as \$399!
 with exchange of your working board

PowerMac 6500/225

• 32MB of RAM **PowerPC**
 • 3GB Hard Drive
 • 225-MHz 603e processor
 • 12X CD-ROM
 Factory Refurb **... \$879**



Newton MessagePad 130

\$279 refurbished
FREE Genuine Leather Carry Case and faxmodem!



PowerMac 4400/200

• 200-MHz 603e processor
 • 32MB RAM, 2GB Hard Drive
 • Internal 12X CD-ROM
 • 586 DOS Compatibility Card
 Factory Refurb **... \$999**

PC Compatible!



MACINTOSH LOGIC BOARDS

| | |
|--|------------|
| 7200/90 logic board, refurbished | ... \$349. |
| LC logic board, refurbished | ... \$49. |
| LC II logic board, refurbished | ... \$179. |
| Mac LCIII logic board, refurbished | ... \$249. |
| Performa 630 logic board, refurbished | ... \$199. |
| Quadra 800 logic board, refurb. (no processor) | ... \$99. |
| Quadra 840AV logic board, refurb. (no processor) | ... \$99. |
| Quadra 900 logic board, refurb. (no processor) | ... \$99. |
| Quadra 950 logic board, refurbished | ... \$299. |
| Performa/LC 550 logic board, refurbished | ... \$249. |
| *Performa 575/580 logic board, refurbished | ... \$399. |

*with exchange

PRINTERS

| | |
|---|-------------|
| Apple 11x17 Color Inkjet Printer NEW, M9500 | ... \$199. |
| Apple StyleWriter 1200, refurbished | ... \$139. |
| Apple Stylewriter 1500, factory refurbished | ... \$199. |
| Apple Color StyleWriter 2400, refurbished | ... \$199. |
| Apple Personal LaserWriter LS, refurbished | ... \$299. |
| Color LaserWriter 12/600PS, refurbished | ... \$1799. |
| Personal LaserWriter NTR, refurbished | ... \$549. |
| LaserWriter IIx w/5MB RAM, refurbished | ... \$699. |
| LaserWriter IIg w/5MB RAM, refurbished | ... \$799. |
| Hewlett-Packard Deskwriter C, refurbished | ... \$199. |
| Texas Instruments Micro Laser Pro E NEW | ... \$699. |

Laser toner cartridges sold separately

APPLE WORKGROUP/WEB SERVERS

| | |
|--|-------------|
| WGS 8550/200 16/2GB/8XCD, refurbished | ... \$1449. |
| WGS 8550/132 24/2GB/8XCD, refurbished | ... \$949. |
| WGS 7250/120 16/2GB/CD/Internet, NEW | ... \$1099. |
| WGS 6150 16/500/CD, refurbished | ... \$649. |
| WGS 9150/120 16/1GB/CD, refurbished | ... \$749. |
| WGS 80 16/500/CD, refurbished | ... \$749. |
| Network Server 500 32/2GB/4XCD, refurbished | ... \$1199. |
| Network Server 700 48/4GB/DAT-2, refurbished | ... \$1699. |

VIDEO CARDS

| | |
|--|------------|
| ATI XClaimVR with FREE TV Option | ... \$179. |
| E-Machines DoubleColor SX (Nubus Card) NEW | ... \$49. |
| RasterOps 24MX NEW, Nubus | ... \$199. |
| Supernac 8.24 PDQ Plus, Nubus | ... \$449. |
| *PowerMac HPV Card (1MB) | ... \$79. |
| *PowerMac A/V Card (2MB) | ... \$249. |

MONITORS

| | |
|--|------------|
| AppleVision 750 17", refurbished | ... \$549. |
| Apple MultipleScan 720, refurbished | ... \$349. |
| Apple 14" A/V NEW | ... \$249. |
| Apple 14" Multiscan, refurbished | ... \$149. |
| Apple 15" Multiscan, factory refurbished | ... \$279. |
| Apple 15" AV, factory refurbished | ... \$299. |
| Apple MultiScan 17", refurbished | ... \$349. |
| Apple 20" Multiscan, refurbished | ... \$999. |
| Radius IntelliColor/20e, factory refurbished | ... \$999. |
| Voxon 14" Multiscan NEW | ... \$179. |
| Voxon 15" Multiscan NEW | ... \$229. |
| Radius Color Pivot LE, refurbished | ... \$299. |
| Radius Color Pivot, refurbished | ... \$249. |

APPLE PC COMPATIBILITY CARDS

| | |
|--|------------|
| Pentium 166-MHz, 12" PCI card, refurbished | ... \$299. |
| 586 100-MHz, 7" PCI card, refurbished | ... \$149. |
| 486 66-MHz for 6100 series, NEW | ... \$59. |

FREE PC CD pack with PC Card Purchase!

NUBUS ADAPTERS

| | |
|--|-----------|
| Quadra 660AV NuBus Adapter | ... \$79. |
| Quadra 610 Nubus Adapter | ... \$79. |
| Ilisi Nubus adapter with math co-processor | ... \$69. |

IMAGING PRODUCTS

| | |
|---|------------|
| Apple Color OneScanner refurbished | ... \$199. |
| Apple Color OneScanner 600/27 refurbished | ... \$299. |
| UMAX UC840 Scanner NEW | ... \$199. |
| Apple QuickTake 200 refurbished | ... CALL. |
| Apple QuickTake 150 refurbished | ... CALL. |

PowerMac CPU SALE!

| | |
|---|--|
| 9500/200 32/2GB/CD \$1249 refurbished | 9500/120 16/1GB/8XCD \$999 refurbished |
| 8500/132 32/2GB/8xCD \$999 refurbished | 7500/100 16/1GB/CD \$779 refurbished |
| 7200/120 16/1GB/CD \$749 refurbished | Performa 5200 12/500/4XCD \$699 refurbished |

PowerComputing Factory Refurbished Systems

| |
|---|
| PowerCenter Pro 180MT • 180-MHz PowerPC 604e, 2MB VRAM • 32MB RAM, 2GB HD, 16XCD-ROM NOW ONLY ... \$1049 |
| PowerBase 180LP • 180-MHz PowerPC 603e, 2MB VRAM • 16MB RAM, 2GB HD, 16XCD-ROM NOW ONLY ... \$679 |
| PowerBase 240MT • 240-MHz PowerPC 603e, 2MB VRAM • 16MB RAM, 1.2GB HD, 16XCD-ROM NOW ONLY ... \$799 |

Save A Mac Foundation

\$99 BOARD BLOWOUT!

Take your pick for only 99 bucks! No exchange!

Ilfx logic board

WOW! *Quadra 900 logic board **\$99!**

*Centris 650 logic board

*Quadra 800/840 logic board

PowerBook 520 or 540 logic board

*Processor not included

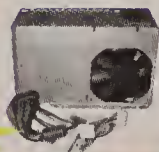

NEW PM7500 POWER SUPPLY ONLY \$229



NEW 7200/75 LOGIC BOARD ONLY \$149

1.44 SuperDrives



STARTING AT \$49!
REFURBISHED
NO EXCHANGE REQUIRED!

MAC LC SERIES POWER SUPPLY

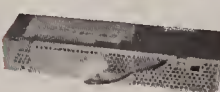

For LC, LCII and LCIII

REFURBISHED **... \$29**



Color StyleWriter LocalTalk Module

Connect your StyleWriter 2400 or 2500 directly to a LocalTalk network!

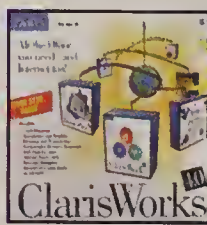

\$39!
ClarisWorks 4 Internet Edition
NEW!

FREE Claris HomePage!

QuickTake Cameras



Refurbished
STARTING AT \$99!!

*Products are refurbished unless indicated as "new". Prices reflect a 2% cash discount and are subject to change without notice. Returns are subject to a 15% restocking fee. Not responsible for typographical errors. All trade-ins MUST BE in working condition. Refurbished systems may include like-new components and may also include cosmetic blemishes which do not functionally impair performance of the hardware.



1-800-533-9005

We are open Mon-Sat, 9am-6pm

Fax Bids: (310) 475-7744 or email us at compuamer@artnet.net
10435 Santa Monica Blvd., Los Angeles, CA 90025

Check out our Web!

WWW.COMPU-AMERICA.COM

Government, University and Fortune 1000 P.O.'s are welcome!
Business Leasing is Available!
International Orders Please call
tel: (310) 446-1771

POWERMACS!

Starting at \$799

| | | |
|------------|------------------------|-------|
| G3/333MT | 128/2-4GW/24X | 2499 |
| G3/300MT | 64/8GIG/24XCD/ZIP | 1999 |
| G3/3000T | 64/6GIG/CO/ZIP | 1699 |
| G3/266MT | 128/4GW/24X/ZIP/6VR | 1899* |
| G3/266MT | 32/6GIG/24X/ZIP | 1699* |
| G3/266DT | 32/4GIG/24X | 1349 |
| G3/233MT | 32/4GIG/24X/MODEM | 1499 |
| G3/2330T | 32/4GIG/24XCO | 1199* |
| 9600/350 | 64/4GIG/24XCD/ZIP | CALL |
| 9600/300 | 64/4GIG/24X/ZIP | CALL |
| 9600/200MP | 32/4GIG/CO | CALL |
| 9600/200 | 32/4GIG/CD | CALL |
| 8600/300 | 32/4GIG/24XCD/ZIP | 1199* |
| 8600/250 | 32/4GIG/12XCD/ZIP | 1099* |
| 8600/200 | 32/2GIG/12XCO/ZIP | 999* |
| 7300/200 | 32/4GIG/CD | 899* |
| 6500/300 | 32/4GIG/CO/FAX | 999* |
| 6500/250 | 32/4GIG/CD/FAX | 899* |
| 6500/225 | 32/3GIG/CO/FAX | 799* |
| 5500/225 | 32/2GIG/CO/15" MONITOR | 899* |
| 4400/200 | 32/2GIG/CO/OOS CARO | 899 |

PERFORMAS

| | | |
|-----------|------------------|------|
| 6400/200V | 16/2.4G/CD/MDD | CALL |
| 6400/200 | 16/2.4GIG/CD/MDD | CALL |
| 6400/180 | 16/1GIG/CD/MDD | CALL |
| 6360/160 | 16/1GIG/CD/MDD | CALL |

WORKGROUP SERVERS

Starting at \$2299

| | | |
|----------|--------------------|------|
| G3/233 | 64/4GIG/CD/SHA | CALL |
| G3/266 | 128/2-4GIG/CD/SHA | 3199 |
| G3/300 | 128/2-8GIG/CD/SHA | 3499 |
| G3/333 | 128/9G/CD | CALL |
| 9650/233 | 64/4G/CD/SHARE/DAT | 2299 |

POWERBOOKS

Starting at \$699

| | | |
|------------|--------------|-------|
| 3400C/240 | 16/3G/CD/MDD | 1699* |
| 3400C/200 | 16/2G/CD/MDD | 1499* |
| 3400C/180 | 16/1G/CD/MDD | 1199* |
| 2400C/180 | 16/2G/CD | 1099* |
| 1400C/166 | 16/2G/CD | 1399* |
| 1400CS/166 | 16/2G/CD | 1299* |
| 1400C/133 | 16/1G/CD | 1199* |
| 1400CS/133 | 16/1G/CD | 999* |
| 1400CS/117 | 12/750 | 899* |
| 5300CS/100 | 16/750 | 699* |

NEW G3 POWERBOOK!

Starting at \$1599

| | | |
|--------|-----------------------|------|
| G3/233 | 32/2G/20X/12.1STN | 1599 |
| G3/233 | 32/2G/20X/12.1STN/56K | 1699 |
| G3/233 | 32/2G/20X/12.1TFT/56K | 1899 |
| G3/233 | 32/2G/20X/13.3TFT | 1999 |
| G3/233 | 32/2G/20X/14.1TFT | 2099 |
| G3/250 | 32/4G/20X/13.3TFT/56K | 2899 |
| G3/266 | 64/4G/20X/14.1TFT/56K | 3099 |
| G3/292 | 64/8G/20X/14.1TFT/56K | 3899 |
| G3/300 | 64/8G/DVD/14.1TFT/56K | 4499 |

SONY

Starting at \$269

| | |
|------------------------|-------------|
| Sony 20SEII | 999 |
| Sony W900 | CALL |
| Sony 100ES/100GS | 269/279 |
| Sony 200ES/200GS/200PS | 399/479/699 |
| Sony 400PS 19" | 779 |
| Sony 300SF 20" | 999 |
| Sony 500PS 21" | 1149 |

ViewSonic

Starting at \$139

| | |
|-------------------------|-------------|
| 041 14" | 139 |
| 051/QS3 15" | 159/169 |
| 071/0100 | 249/599 |
| E641/E655 | 139/199 |
| V73/V75 17" | 319/379 |
| V95/V115 | 499/849 |
| G771/G773 | 329/379 |
| G775/G790 | 479/499 |
| P775/PT775/PT771 | 499/549/549 |
| G810/P810 | 899/999 |
| PT813/P815 | 1099/1099 |
| 29GA | 1649 |
| VIEWSDNIC VWPAN VPA138 | 789 |
| VIEWSDNIC VWPAN VPA 14S | 799 |
| VIEWSDNIC VWPAN VPA 150 | 1029 |
| PROJECTOR 800 | CALL |

HEWLETT PACKARD

Starting at \$99

| | |
|--------------|-----------|
| 5000N | CALL |
| 4000N/4000TN | 1299/1399 |
| 6MP | 799 |
| 4MV | 1099 |

UMAX

Starting at \$99

| | |
|-------------------------------|----------|
| VISTA Astra 610s-Photo Deluxe | 99 |
| VISTA Astra 1200/1220 | 249/159 |
| VISTA Astra PDWORLDKII/III | 929/CALL |
| VISTA Astra PDWORLDKX 3000 | CALL |
| Mirage ISE w/Trans | 2299 |

EPSON

Starting at \$139

| | |
|------------------------|----------|
| STYLUS COLDR 700/850 | 229/325 |
| STYLUS COLDR 600/800 | 139*/220 |
| STYLUS COLDR Photo-EX | 449 |
| STYLUS PRD-XL | 299* |
| STYLUS COLDR 1520/3000 | 449/1149 |
| EXPRESSIDN/636/EXEC | 529 |
| EXPRESSIDN/636/ART | 699 |
| EXPRESSIDN/636/PRD | 979 |

HEWLETT PACKARD

Starting at \$99

| | |
|-------------------------------|----------|
| VISTA Astra 610s-Photo Deluxe | 99 |
| VISTA Astra 1200/1220 | 249/159 |
| VISTA Astra PDWORLDKII/III | 929/CALL |
| VISTA Astra PDWORLDKX 3000 | CALL |
| Mirage ISE w/Trans | 2299 |

WACOM

Starting at \$269

| | |
|-------------------------|-----|
| ARTZ II 6 X 8 | 269 |
| ARTZ II 12 X 12 | 379 |
| ARTZ II 6 X 8 W/PAINTER | 549 |
| ARTZ II 12 X 18 | 629 |

iomega

Starting at \$79

| | |
|------------------|-----|
| ZIP DRIVE 100 MB | 110 |
| ZIP DRIVE PLUS | 129 |
| ZIP CART 10 PACK | 79 |
| JAZZ DRIVE 2 GIG | 329 |
| JAZZ DRIVE 1 GIG | 229 |
| JAZZ CART 1 GIG | 69 |
| JAZZ CART 2 GIG | 69 |

GLOBAL VILLAGE

| | |
|-------------------------------------|-----|
| Global Village Plat 56K EXT | 129 |
| Global Village 28.8 PCMCIA | 59 |
| Global Village 28.8/ETHERNET PCMCIA | 99 |
| Global Village 56.6 PCMCIA | 159 |
| Global Village 56.6 ETH/PCM | 189 |

YOUR #1 COMPUTER SUPERSTORE!

All prices are cash discounted. ** denotes a refurbished product. Not responsible for typos. Apple, the Apple logo, GeoPort, HyperCard, ImageWriter, LaserWriter, Mac, Mac OS logo, Macintosh, MessagePad, Newton, OpenDoc, PowerMacintosh, PowerBook, QuickTake, QuickTime, QuickTime logo and StyleWriter are trademarks of Apple Computer, Inc., registered in the U.S. and other countries. All other names & logos are trademarked by their respective owners. We are Not Apple Authorized.

"Custom Configuration Specialists"

- Dealers & International sales welcome!
- Govt., University & Corporate P.O.'s Welcome.
- Best Prices, Service & Delivery.



Toll free: (800) 589-1234

Int. (310) 470-9426 Fax: (310) 470-4956
2289 Westwood Blvd. Los Angeles, CA. 90064

www.infinity-micro.com

Largest & Most Complete Mail order Source!

SYSTEMS

| | | |
|---------------|----------------------|------|
| G3/2330T | 32/4GB/24XCD/KB | 1279 |
| G3/233MT | 32/4GB/24XCD/56K/KB | call |
| G3/266DT | 32/4GB/24XCD/AV | 1479 |
| G3/266MT | 32/6GB/24XCD/ZIP/AV* | 1695 |
| G3/266MT | 32/6GB/24XCD/ZIP/AV | call |
| G3/266MT | 128/4GW/24XCD/8MB | 2195 |
| G3/300DT | 64/6G/24XCD/ZIP | 1789 |
| G3/300MT | 64/8GIG/24XCD/6MB | 2175 |
| G3/300MT | 128/2-4GW/24X/8MB | 3295 |
| G3/333MT | 128/9G/24XCD... | 2695 |
| 9600/350 | 64/4GB/24XCD/Zip | 3195 |
| 9600/300 | 9600/233/9600/200 | CALL |
| 8600/300 | 32/4GB/12XCO/Zip | CALL |
| 8600/250 | 32/4GB/CD/ZIP | CALL |
| 8600/200 | 32/2GB/12XCD | 1295 |
| 7600/132 | 16/1GB/8XCD* | 895 |
| 7300/200 | 32/2GB/24XCD/ZIP | call |
| 7300/180 | 16/2GB/CO/KB | 995 |
| 7300/180 | 16/2GB/CD/DOS | 1295 |
| 7100/80 | 8/500/CD | 495 |
| 6500/300 | 32/4GB/12XCD | 995 |
| 6500/300 | 32/4GB/12X/33.6/AVID | 1095 |
| 6500/275 | 32/6GB/24XCD/56/ZIP | 1095 |
| 6500/275 | 32/6GB/CO | 849 |
| 4400/200 | 32/2GB/CD/DOS | 995 |
| 5500/225 | 32/2GB/12X/15" | 995 |
| 5400/180 | 16/1.2/8XCD/15" | 895 |
| 7200/120 | 16/1.2/8XCD | 695 |
| ALL IN ONE G3 | | call |
| IMAC G3/233 | 32/4GB/24X/15" | 1279 |

Specials

| | |
|--------------------------|---------|
| Magnavox 20" Color | \$ 495. |
| Stylewriter 4500 Printer | \$ 299. |
| 19.2 Fax PB-500 Series | \$ 79. |
| Powerbook 180 12/160/mdm | \$ 495. |

PRINCETON

| | |
|--------------------|---------|
| EO90 19" COLOR | 645 |
| EO70 17"/EO75 17" | 399/549 |
| EO74 17"/EO710 17" | 599/529 |
| EO50/EO500 | 289/339 |

MONITORS

| | |
|-----------|-----------|
| 15" AV | 319 |
| 1705/1710 | 399/499 |
| 720 | 549 |
| 750/750AV | 679/759 |
| 850/850AV | 1395/1095 |

NOTEBOOKS

| | | |
|----------------------|----------------------|---------|
| G3/300 | 64/8GB/DVD/56K/14.1" | 4895 |
| G3/292 | 64/8GB/20X/56K/14.1" | 4395 |
| G3/266 | 64/4GB/20X/56K/14.1" | 3295 |
| G3/250 | 32/5GB/20XCD/56K | 2895 |
| G3/233 | 32/2GB/20X/56K/14.1" | 2295 |
| G3/233 | 32/2GB/20XCD/13.3" | 1995 |
| G3/233 | 32/2GB/20X/56K/12.1" | 1795 |
| G3/233 | 32/2GB/20X/12.1" | 1895 |
| 3400C/240 | 16/3GB/12XCD | 1995 |
| 3400C/200 | 16/2GB/12XCD | 1695 |
| 3400C/180 | 16/1.3G/8XCD | 1495 |
| 1400C/166 | 16/2GB/8XCD | Call |
| 1400CS/166 | 16/2GB/8XCD | 1495 |
| 5300C | 16/1GIG/16/750 | 895/849 |
| 5300CS | 8/750/16/750 | 649/699 |
| 2300C | 20/1GIG/14.4" | 995 |
| 2400C/180 | 16/1.3GIG | 1495 |
| 540C | 32/500/19.2MDM | 795 |
| 180 14/120/14.4 Fax* | | 495 |
| Apple Duo Dock II | | 195 |

ARE YOU LOOKING FOR 6PCI SLOT MACHINES?

PowerMac 9600

G3/333Mhz upgraded 32/4GB/24xCD/ZIP

6 PCI Slot Machines

running at a speed of a PowerMac G3/333Mhz

CALL 800-589-1234

HEWLETT PACKARD

| | |
|-----------------|-----------|
| LaserJet 5MP | 595 |
| LaserJet 6MP | 779 |
| DeskJet 890cxi | 389 |
| DeskJet 1600CM | 1395 |
| LaserJet 4000N | 1089/1395 |
| LaserJet 4000TN | 1529 |
| LaserJet 4MV | 1495 |
| LaserJet 5000 | 1295 |
| LaserJet 5000N | 1795 |
| LaserJet 5000GN | 2095 |

GCC TECHNOLOGIES

NEW Elite SERIES

| | |
|--------------------------|------|
| Elite XL-608 | CALL |
| Elite XL-616 | CALL |
| Elite XL-808 | CALL |
| Elite XL-1208 | CALL |
| Elite XL-1208 Platemaker | CALL |

EPSON

| | |
|---------------------------|---------|
| Epson Stylus 600/800 | 195/295 |
| Epson Stylus 850/850N | 349/449 |
| Epson Stylus 1520 | 729 |
| Epson Stylus 3000 Color | 1549 |
| Epson Stylus Pro-XL 11x17 | 289 |

Seagate

Barracuda 18.2GIG

\$799.00

GLOBAL VILLAGE

| | |
|------------------------|-----|
| TELEPORT 56K FLEX v95 | 129 |
| POWERPORT 56K PCMCIA | 179 |
| POWERPORT 56K ETHERNET | 279 |
| POWERPORT MERCURY/500 | 79 |

AGFA

| | |
|-----------------------|---------|
| SnapScan 310/600 | 179/339 |
| Snapscan 600-ART LINE | 339 |
| Arcuss II Solo | 1289 |
| Arcuss II | 895 |

EPSON

| | |
|------------------------------|------|
| Epson Exp. 636 Executive | 635 |
| Epson Exp. 636 Artist 600dpi | 795 |
| Epson Exp. 636 Professional | 1195 |

MICROTEK

| | |
|--------------------------|------|
| Microtek Scanmaker V600 | 119 |
| Microteck ScanMaker V310 | 79 |
| Microteck ScanMaker III | 1095 |

UMAX

WE HAVE THE LOWEST PRICES ON ANY MEMORY PRODUCTS

| | |
|---------------------------------|------|
| Umax Astra 610s 300dpi | 99 |
| Umax Astra 1200s 600dpi, P.delx | 375 |
| Umax Astra 1200s 600dpi, P.shop | 419 |
| Umax PowerLook II/2000 | 1195 |
| Umax PowerLook III | 3195 |

SONY

| | |
|-------------|-----------|
| 100ES/100GS | 249/289 |
| 200ES/200GS | 549/589 |
| 200PS/400PS | 749/1049 |
| 300SF/500PS | 1095/1229 |

specials

| | |
|---------------------|-----|
| Radius 15" Pivot* | 99 |
| Radius 20" Color* | 499 |
| Supercam 20" Color* | 499 |

LEASING AVAILABLE!!!

Just Call and ask about our quickleasing programs starting as low as \$99.00 per month

Call and ask for Ext. 135

SOFTWARE/Academic

| | |
|-------------------------------|------|
| Adobe Photoshop version 5.0 | 295 |
| Adobe Illustrator version 7.0 | 279 |
| Adobe Pagemaker vers. 6.5 | 279 |
| Adobe After Effects | 1095 |
| Quark Express package | 699 |
| Microsoft Office package 98 | 295 |

RASTEROPS

| | |
|----------------------------|------|
| MC 620 17" | 439 |
| MC 6315 17" | 585 |
| MC 7515 19" | 795 |
| MC 801 21" | 1095 |
| MC 801HR 21" | 1179 |
| Rasterops 20" Black&white. | 195 |

WACOM

| | |
|------------------------|-----|
| ARTZ II 6x8 | 259 |
| ARTZ II 12x12 | 359 |
| ARTZ II 6x8 W. PAINTER | 539 |
| ARTZ II 12x18 | 619 |

iomega

| | |
|---------------------|---------|
| ZIP DRIVE/ZIP PLUS | 129/179 |
| JAZZ 1GIG/JAZZ 2GIG | 269/399 |

PHILIPS/MAGNAVOX 4 YEAR ON SITE WARRANTY!

| | | | | |
|-----------------|------------------|------------------|------------------|------------------|
| \$701 To \$1200 | \$1201 To \$2000 | \$2001 To \$3000 | \$3001 To \$4000 | \$4001 To \$5000 |
| \$ 148.95 | 169.95 | 209.95 | \$ 254.95 | \$ 279.95 |

*Prices are cash discounted & subject to change w/o notice. Visa, MC, Amex, Govt., university & corporate P.O.'s welcome. * = factory reconditioned units.

Monitors New Year's Blowout Video Cards

MONITORS

Radius Intellicolor 20e
20" Trinitron 1600x1200
NOW \$799!!



20" COLOR MONITORS

- Sony 20" Trinitron \$599
- Radius Multi-Resolution Trinitron (New) \$749
- Radius Intellicolor 20 \$799
- 21" COLOR MONITORS
- Radius 21" PressViews \$1299
- Radius PrecisionView 21 \$1049
- Radius MultiView 21 Super Fine .25DP \$999
- RasterOps Hitachi SuperScan 21 (New) \$999
- Ikegami 21" Diamondtron (NEW) 2Yr. Warr \$1049

15 & 17" COLOR MONITORS

- Portrait Display Labs 1700 \$699
- Radius Pressview 17Sr \$1399
- Radius 15" Pivot, Color & Grayscale \$99
- GRAYSCALE MONITORS
- Radius 21" Two Page Grayscale \$499!
- Radius Full Page Display \$299
- Radius 15" Grayscale \$99

Radius Precision Color Pivot

- Blowout Price!!
- View Full Page Text and Graphics!
- Up To 1024 X 768

GRAPHICS CARDS

Thunder IV GX from \$699



WORLD'S LARGEST SUPPLIER OF NUBUS PRODUCTS!
NUBUS CARDS

24bit Accelerated Graphics Cards

- Compatible G3 Upgrade & OS8 Nubus Cards
- Futura Series (up to 1024x624) \$89*
- Radius 24xp (832x768) \$149*
- Spectrum 24 Series V (1024x768) \$199*
- Spectrum Power (1152x870) \$299*
- Thunder II GX (1152x870 up to 1600x1200) from \$299*
- PhotoEngine increase PhotoShop 15x's FREE*
- Thunder IV GX (1152x870 up to 1600x1200) from \$699*

PCI CARDS

- RasterOps Twin Turbo 24bit from \$179
- Radius ThunderColor 30/1152 \$549
- Radius ThunderColor 30/1600 \$699
- Radius ThunderPower 30/1920 \$749
- Radius Thunder 3D \$1399
- Radius Thunder TX \$799
- Radius Tempest \$449
- Radius PrecisionColor 8/1600 \$299
- Radius PrecisionColor 24/1600 \$399!

Most Radius, SuperMac & Emachine monitors in stock
*With Qualifying Monitor or Video Card Purchase

DIGITAL VIDEO

Spigot Pro AV and Power AV from \$199

Video Spigot Cards from \$99

VideoVision Telecast \$799!!



VideoVision Nubus and PCI
• Broadcast quality video output
• Proven Non-Linear Video editing technology \$699!!

Digital Video Workstation!

- \$1849!
- PowerMac 81/110
- 32/2GB/cd
- 15" Color Monitor
- VideoVision Studio 2.5.1
- Adobe Premiere



Graphics Workstation!

- \$1649!
- PowerMac 81/110
- 32/2GB/cd
- 21" Two Page Color Monitor



PRINTERS

Apple LaserWriter \$199

Apple Personal LaserWriter NT \$299

Apple LaserWriter IIF \$399

QMS 860 Hammerhead \$1300

Proof Positive Color Printer

- Continuous-Tone, Photo-Realistic, Proof to Press Color Simulation
- Full Page & Two Page Options Available
- True Postscript Level 2
- Prints Match Prints



COMPUTERS

Mac Ilcx \$249!

- 4mt/160 HardDrive
- 15" Grayscale Pivot
- Color Monitors Available

Mac Surplus- macsurplus.nubus.com- 800-444-9088

Mac Surplus, Inc. 14609 Dartmouth Dallas, TX 75244 Monday thru Friday 9AM to 6PM CST

Domestic Sales macsurplus@nubus.com Fax 254.299.2705 Consultants/Dealers 254.299.2705 International Sales 254.299.2705

Prices reflect 2% cash discount. Prices subject to change. Not liable for typographical errors. Dealers and consultants call for quantity pricing. We ship anywhere.

All Monitors, Printers, and CPUs are Factory Recertified unless otherwise stated. Call for latest pricing & availability on NEW Options.

www.lacc.com

LA computer center

800-689-3933

450 N. Oak St.
Inglewood, CA 90302
Service (310) 671-4444
Fax (310) 671-9565

5 minutes from LAX Airport
Monitors SONY

- | | | | |
|---------------------------|-------|----------------|-------------|
| Apple® 15" AV | 299. | Sony 100ES/GS | 269./ 279. |
| Apple® 720 17" | 429. | Sony 200ES 17" | 399. |
| Apple® 750 17" | 599. | Sony 200GS/PS | 499. / 699. |
| Apple® Color Sync 17" | 799. | Sony 400PS | 779. |
| Apple® 850 AV 20" | 1199. | Sony 500PS | 1199. |
| Apple® Color Sync 20" | 1399. | Sony W900 | CALL. |
| Apple® Studio LCD Display | CALL. | | |

ViewSonic
Q41 14"/Q51 15"/Q71 149./150./249.

- | | | | |
|--------------------------------|-------|------------------------------|-------|
| EA771 17" 1024x768 w/spk .28dp | 429. | Mc 620 17" .28dp 1152X870 | 349. |
| G771 17" 1024x768 27dp | 379. | Mc 6315 17" .22dp 1280X1024 | 449. |
| G730 19" 1280x1024 .28dp | 679. | Mc 7515 19" .22dp 1600X1200 | 639. |
| P775 17" 1600x1280 .25dp | 499. | Mc 2110 21" .26dp 1600x1200 | CALL. |
| PT775 17" 1600x1200 .25dp | 549. | Mc 801 21" .22dp 1600X1200 | 979. |
| P815 21" 1600x1200 .25dp | 1099. | Mc 801HR 21" .22dp 1600X1280 | 1149. |
| G810 21" 1600x1200 .28dp | 899. | | |
| P810 21" 1600X1200 .25dp | 999. | | |
| View Panel VPA 150 | 1199. | | |

All prices subject to change without notice
• All Prices reflect cash discount
• reflects Factory refurbished units

MC7515 19" .22DP
1600X1200 Monitor MC801
\$639!

21" .22DP
1600X1200 Monitor MC801
\$979!

4400/200 DOS

- 32MB
 - 2GB
 - 12xCD
 - DOS Card
- \$899

G3 233MHz

- 32MB
 - 4GB
 - 24xCD
 - Desktop
- \$1199*

- CALL FOR NEW G4'S !!!
- | | |
|----------------------------------|--------|
| G3 333MT 128/2-4GB Wide /24x | 2499. |
| G3 300MT AV64/8GB /CD24x/ZIP | 1899. |
| G3 300DT 64/6GB/24x/ZIP | 1599. |
| G3 266DT 32/4GB/24x | 1299. |
| G3 266MT 32/6GB/24x/AV | 1699* |
| G3 266MT 128/4GBW/24x/Zip/6MB VR | 1899* |
| 9600/350 64/4G/24xCD | CALL |
| 9600/300 64/4GB/24CD | CALL |
| 9600/233 32/4G/12xCD | CALL |
| 9600/200MP 32/4G/12xCD | CALL |
| 8600/300 32/4G/24xCD/ZIP | 1299.* |
| 8600/250 32/4GB/24xCD/ZIP | 1199.* |
| 8600/200 32/2G/CD | 1099.* |
| 8500/180 32/2G/8xCD | 999.* |
| 7300/200 32/2G/CD/KBRD. | CALL |
| 4400/200 32/2GB/12x | 799* |
| 6500/225 32/3G/12x/fax | 749* |
| 6500/250 32/4GB/CD/fax | 849* |
| 6500/300 64/6G/CD/Zip | 899. |
| iMAC & ALL IN 1 G3'S | 699. |

SERVERS

- | | |
|--------------------------------|-------|
| G3/233 64/4G UWide/CD/Share | 2499. |
| G3/266 128/2-4G UWide/CD/Share | 3199. |
| G3/300 128/2-8G UWide/CD/Share | 3499. |
| 9650/350 64/4G/20X | 2699. |

EPSON PRINTERS

- | | |
|----------------------------|-------------|
| Epson Stylus Color 600/800 | 109* / 219. |
| Epson Stylus Color 850/700 | 325 / 229. |
| Epson Stylus Color 3000 | 1199. |
| Epson Stylus Photo EX | 449. |

Epson Pro XL

- \$279*
- Post Script Option \$249.
- Ethernet Option \$349.

G3 292MHz

- 64MB
 - 8GB
 - DVD
 - 14.1 Active
 - 56k Modem
- \$3799

- | | |
|--------------------------------------|--------|
| G3 233MHz 32/2G/20X/12 1DSTN | 1599. |
| G3 233MHz 32/2G/20X/12.1DSTN/56K | 1699. |
| G3 233MHz 32/2G/20X/TFT/13.3TFT | 1899. |
| G3 233MHz 32/2G/20X/TFT/14.4TFT | 2099. |
| CALL G3 250MHz 32/4G/20X/56K/13.3TFT | 2799. |
| CALL G3 292MHz 64/8G/20X/56K/DVD | 3799. |
| CALL G3 300MHz 64/8G/DVD/56K/14.1TFT | 4299. |
| 1400cs 166MHz 16/2G/CD | 1299*. |
| 1400cs 117MHz 12/1.2G | 899. |
| 3400c 180MHz 16/1.3G/CD | 1199.* |
| 3400c200MHz 16/2.0G/CD | 1399*. |
| 3400c 240MHz 16/3G/CD/Modem | 1599*. |
| 2400c180MHz 16/1.2G | 1299*. |
| 5300c 16/750 | 899. |
| 5300cs 8/500 | 699. |
| 540c 4/320 / 520c 4/240 / 520 4/240 | CALL. |
| DUO250* DUO280* DUO280C* | CALL. |

- | | |
|--|------|
| Powerbook Batteries for 1400,5300,190 | 119. |
| Zip 100MB For G3 PowerBooks | 199. |
| Charger for 1400 w/AC adapter | 129. |
| Charger for 1400 battery & Apple ac Adapt. | 199. |
| 3400 Mobility Bundle (Charger, AC & Batt) | 249. |
| 3400 Apple Li-Ion Battery | 129. |
| Auto Adapter for 3400,1400 & G3 | 69. |
| Power Adapter 3400,5300,G3 & 190 | 149. |

WE BUY AND SELL USED MACINTOSH

Trade in your old MAC for a new one. Top \$\$\$ paid for trade ins

Apple Printers

- | | |
|----------------------------|-------|
| Apple® Laser 12/640 | 849*. |
| Apple® Laser 16/600PS | 999*. |
| Apple® Laser 8500 | 1499. |
| Apple® Laser Writer 4/600* | CALL. |
| Color Portable 2200 | 299*. |

Ultimate Rez 8MB Video Card \$399

ix3D ULTIMATE REZ

| | |
|---------------------------|------|
| Ultimate Rez 8MB | 399. |
| Mac Rocket w/4MB SGRAM | 199. |
| 8MB Twin Turbo Video Card | 369. |
| Pro Rez 8MB | 259. |
| 4MB Twin Turbo Video Card | 149. |
| Turbo TV | 89. |

Quantum Atlas II 9GB Ultra SCSI/Wide External \$399/\$459

PHILIPS/MAGNAVOX 4 YEAR ON SITE WARRANTY!

CALL THE MAC EXPERTS!

Your one-stop source for everything Macintosh®. Complete solutions and expert advice our specialty!
Call for the absolute lowest prices and immediate delivery on over 20,000 Mac® products!

If there could be only one Macintosh® reseller in the world, why you'd want it to be PowerMax:

- Our salespeople are some of the most knowledgeable in the business. They're not order takers and they don't push for a one time sale. Well over half our business comes from repeat and referred customers!
- We have 800 line tech support for as long as you own your computer!
- We load over 160 megabytes of useful software on every computer.
- Every Mac® system is thoroughly bench tested, and then personally verified and approved by your specific consultant.
- We will customize your computer any way you need, and always with an exact description as to what we're including.
- We give you a free mouse pad with every system.
- We have no voice mail- there's always a human being on the other end of the line- for tech, sales and management.
- We answer the phone: "how can we help you?" not "may I take your order?"
- We live in Oregon, where there is no sales tax and the people are friendly and polite!
- Even customized systems usually ship within 24-48 hours.
- Government and corporate purchase orders normally approved the same day.
- We take trade-ins, and we sell every style of quality Macintosh® possible, from extreme hi-end to quality used Macs®.
- We have competitive prices on over 30,000 Macintosh® items.
- All we do is Macintosh®- our company is run entirely on Macs®.
- We offer you choices: buy over the phone, over the internet, or in person, all with the same great prices and super service!

The other guys

- They sell you a box.
- If you have a problem, they tell you to call the manufacturer. And then you get to wait on hold for a long, long time.



Package 61W991

Package includes pre-tested 6100/66 with 16 Mb RAM, 500 Mb hard drive, internal CD-ROM, a new 14" color display and extended keyboard. Only \$499!!

SAVE BIG on these complete packages!



Package 71W991

Package includes pre-tested 7100/80 with 16 Mb RAM, 500 Mb hard drive, a new 14" color display and extended keyboard. Only \$549!!

Only while supplies last

• Both Systems are G3 Upgradable! •

Pictures may not match monitor in package

Package 26W991

PowerMac® G3 266 desktop, 64 mb RAM, 4 Gb Drive, 24x CD, 15" Color Display and Microsoft Office 98 plus Premiere 4.21LE! Only \$1888, or just \$76 per month!

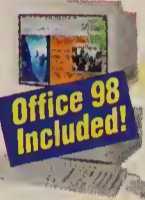

Office 98 Included!

Package 33W991

PowerMac® G3 266 MHz Tower (factory ref) w/ 64 Mb RAM, 6 gig drive, 24x CD, internal Zip drive, 17" PowerMax Trinitron display, and Premiere 4.21LE! Only \$2299, or just \$93 per month!



Extra RAM and a Trinitron™ Display!



Call for complete USB info!

The iMac

Cool little computer- and make sure its everything you need your Mac to be by calling the Mac® Experts for a complete analysis of your computing needs!

We're Video Production Experts!

Set up your own video production studio with this awesome system designed by PowerMax, your nationally authorized Media 100 source!

Package # CB19768

System includes: G3 333MHz Tower, 256 Mb RAM, two 9 Gb Ultra-Wide hard drives with Express Raid striping software, Media 100 QX card w/Adobe Premiere and Adobe After Effects, internal Jaz 1 Gb drive, and a 20" Trinitron™ display. All for only \$7,779, or just \$279/mo.



Complete Media 100 Video Workstation!

We're Used Mac® Experts!

We'll take your Macintosh® computer in trade toward the purchase of any product we sell! Call one of our expert Mac® consultants for complete details! Or call for our complete inventory of pre-tested used machines- some of today's best Mac values!

Trade Up



We Offer Exclusive Blowout Deals!

NOMAI 540MB REMOVABLE DRIVE BLOWOUT!



\$99!

Five times the capacity of a Zip, as fast as a hard drive, and at a lower price! Features 10 ms. seek time and sustained data transfer rate between 3 & 5 mb per second.

We're Upgrade/Add-on Experts!

We don't have room to list the thousands of items we have to enhance your Macintosh®- speed upgrades, extra storage, RAM, parts, you name it- we got it!

| | | | |
|---------------------------------------|--------|----------------------------------|-------|
| 233MHz 604e Upgrade Card | \$199 | External 2 Gb Hard Drive | \$219 |
| Upgrade your 6100 to G3@225MHz! | \$388 | External 4 Gb Hard Drive | \$259 |
| Upgr your PCI Mac to G3@233MHz! | \$345 | Internal 24x CD-ROM Drive | \$75 |
| Upgr your PCI Mac to G3@400MHz! | \$1969 | External 24x CD-ROM Drive | \$109 |
| iMac or WallStreet 128 Mb Ram | \$229 | Internal Apple G3 56k Modem..... | \$175 |
| External 1 Gb Hard Drive | \$189 | ...And thousands more! | |

We're Monitor Experts!

| | |
|--|-------|
| Model PM15T 25 mm dot pitch- up to 1280x1024 | \$288 |
| Model PM17T 25 mm dot pitch- up to 1280x1024 | \$479 |
| Model PM17TE+ 25 mm dot pitch- up to 1600x1280 | \$649 |
| Model PM20T 30 mm dot pitch- up to 1600x1280 | \$799 |
| Model PM20T+ 25 mm dot pitch! | \$899 |



PowerMax Trinitron® monitors are designed specifically for the rigorous demands of the Macintosh®. They ship complete with Mac®-ready cables and adapters, a three year warranty, and our satisfaction guarantee: if the monitor is not just right, we'll replace it for you!

MacUser
Labs
Reviews:

"Four Mice! A Power-Max Power Play" and "Not only do the PowerMax monitors display good-looking images, but (they) are affordably priced!" and "Nice price, nice image quality, nice controls - nice monitor!"

We're System Experts!

Hundreds of fully-tested used and factory refurbished Macs® always in stock- complete with great warranties!

| | |
|---|---------|
| Used 6100/60 16/350/CD | \$339 |
| Used 6200/75 24/Gig/CD | \$349 |
| Used PowerCenter 150 0/0 | \$499 |
| Refurb 6360/160 16/1.2 Gb/CD | \$589 |
| Used 8100/80 24/500 | \$629 |
| Refurb PwrBase 240 16/2 Gb Tower | \$649 |
| New 4400/200 16/2/CD | \$688 |
| Refurb 6500/250 32/4 Gb/56k | \$Coll! |
| Refurb 6500/275 48/6 Gb/56k.SBlowout! | |
| The latest G3's at the greatest prices! | |
| iMac 233 32/4 Gb/CD/56k | \$1295 |
| G3 266 DT 32/24x/Enet | \$1388 |
| G3 266 DT 32/24x/4 Gb/Enet | \$1488 |

| | |
|---|--------|
| G3 266 DT 32/24x/4 Gb/Enet/Zip | \$1599 |
| G3 266 DT 96/24x/6 Gb/Enet/Zip | \$1749 |
| Ref G3/266 Twr 32/6 Gb/CD/Zip | \$1788 |
| G3 300 DT 64/24x/Zip | \$1798 |
| G3 300 DT 32/4 Gb/DVD | \$1999 |
| G3 300 Tower 64/8 Gb/24x/Zip | \$2299 |
| G3 333 Tower 128/9 Gb UW/24x | \$2849 |
| You won't find better deals on Powerbooks® and all accessories than PowerMax! | |
| G3 233 32/2 Gb 12.1 DualScan | \$1999 |
| G3 233 32/2 Gb 14.1 Active | \$2449 |
| G3 250 32/4 Gb 13.3 Active | \$3188 |
| G3 266 64/4 Gb 14.1 Active | \$3388 |
| G3 300 64/8 Gb 14.1 Active | \$4888 |
| Used 180C 14/160/14.4 w/carrying case & auto adapter | \$399 |

Model 5200:
All-in-one is perfect for home & school!

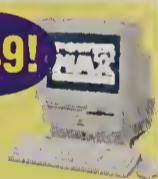

| | |
|---|--------|
| Powerbooks® (Cont.) | |
| Used 5300C 16/750 | \$788 |
| Ref 5300C 16/750 | \$949 |
| Ref 1400CS/133 16/1 Gb/CD | \$1199 |
| Ref 1400C/133 16/1.3/CD | \$1349 |
| Ref 3400C/180 16/1 Gb | \$1488 |
| Ref 1400C/117 16/1 Gb/CD | \$1149 |
| Ref 1400CS/133 16/1 Gb/CD | \$1199 |
| Ref 1400C/133 16/1.3/CD | \$1399 |
| Ref 3400C/180 16/1 Gb | \$1488 |
| Apple Battery for 3400 Powerbooks | \$179 |
| NuPowr G3 250MHz for 1400 | \$999 |

We're out of room! Call for great prices on RAM, Powerbooks®, software, laser printers, scanners, CD-ROMS, video cards, storage products, color printers, media, printing solutions.

800-613-2072
Local: (503) 624-1827 • Fax (503) 624-1635
email: sales@powermax.com

OR ORDER ON LINE AT
WWW.POWERMAX.COM!
OVER 20,000 MAC® ITEMS AT
YOUR FINGERTIPS!



Prices subject to change without notice. Prices reflect cash discount. Credit card orders strictly verified against fraudulent use. With use of credit card as payment customer acknowledges that some products are subject to final sale. All brand or product names are registered trademarks of their respective holders.

We accept educational and corporate purchase orders, and are experts in financing for virtually any size business!

800-673-MACS

916 • 652 • 1880 FAX 916 • 652 • 1881 800 • 673 • 6227

Office 98
\$149
 Qty 5+ \$129

BONUS:
 Buy ANY G3 or PowerMac and get **\$99** w/purchase MS Office 98 for only

Macintosh Ready
24x CDROMS
\$89 Internal **\$119** External
 Buy any 24x CDROM & get 10 CDs FREE

- * Dragon's Lair
- * Interactive
- * Mayo Clinic
- * Hell Cab
- * Mad Dog McCree
- * 2000 Fonts
- * Dracula Unleashed
- * Internet Executive
- * Stowaway!
- * SiriusNet
- * Intech - CDROM
- * Speed Tools

68k Macintosh
 Quadra/Centris 610 16/160 -ENet (U)
 16/160 13" Color Mtr, Ext Kybd, **\$299**

Mac Iix 0/0-mse(U) 59 Mac Iivx 8/0-mse(U) 99
 Mac Iicx 0/0-mse(U) 59 C/Q 610 8/0-enet 149
 Mac LC 2/0-mse(U) 59 Q700 0/0-mse (U) 149
 Mac Iisi 1/0-mse(U) 59 C/Q 660av 8/0 199
 Mac Iici 0/0-mse(U) 99 Q650 8/0-enet, mse 199
 Mac Iifx 0/0-mse(U) 99 PARTS IN STOCK

HDs & CDROMs
 IBM Ultra SCSI 2.1GB (P)
 5400 RPM 3.5" TH SCSI Incl. SCA adapter **\$129**

ZIP/HD/CDROM Install Kits IN STOCK
 Apple 2x 300+ CDROM-Internal (P) ... 49.00
 Apple 12x 1800i CDROM-Int.(N) ... 139.00
 Apple 24x 3600i CDROM-Int.(N) ... 169.00
 CD External Cases-SCSI cbl incl (N) ... 39.00
 HD External Cases-SCSI cbl incl (N) ... 49.00
 1 GB SCSI -Int 3.5" (P) ... 99.00
 2 GB SCSI -Int 3.5" (P) ... 129.00
 4 GB SCSI -Int 3.5" (P) ... 189.00
 9 GB SCSI -Int 3.5" (P) ... 419.00
 3 GB G3 EIDE-Internal 3.5" (N) ... 89.00
 5 GB Performa IDE-Internal 3.5" (P) .. 199.00
 Apple Floppy Drives-Manual/Auto (N) .. 99.00
 Apple Floppy Drives-Manual/Auto (P/R) 79.00

FREE STUFF!!
 Buy any 68k Mac Package Deal & get a Motorola 28.8bps modem or ethernet upgrade* FREE!!

Mac Iicx 8/80-13" mtr, key,mse , Work 2.0 (U) 189.00
 Mac Iisi 9/80-13" mtr, key,mse , Work 2.0 (U) 199.00
 Mac Iifx 4/80-13" mtr,kybd, Photoshop 2.5LE 249.00
 Mac Iivx 8/80-13" mtr,kybd & MS Wks 2.0 ... 249.00
 Q650 16/240/CD -13" mtr,kybd, MS Wks 2.0 399.00
 Q650 16/2G/CD -13" mtr,kybd, MS Wks 2.0 499.00
 Q650 32/2G/CD -20" color mtr,kybd 599.00
 Q950 20/2G-13" mtr,kybd, Photoshop 2.5LE ... 499.00
 Network Server 500/132-NEW 2950.00

Monitors
 Apple 15" MS Mtr (U) MultiScan tilt/swivel base Built-In Speakers **\$229**

NuBus Video Cards CALL
 Apple 13" RGB-Trinitron, Color (U) 119.00
 Apple 14" RGB-Trinitron, Color (U) 179.00
 Apple 15" MultiScan-Color, Speakers (U) .. 229.00
 Apple 17" MultiScan-Color, Trinitron(U) .. 299.00
 17" RGB-SuperMac/Radius/Rasterops, Color (U) 179.00
 20" RGB-SuperMac/Radius, Color (U) ... 299.00
 20" RGB-Trinitron, Color (U) 399.00
 Apple 20" TPD-Two Page, w/ Cbl (U) 99.00
 Video Cables & Adaptors IN STOCK

PowerMacs
 PwrMac 7100-66 16/500/CD (U) Power PC 601 66Mhz Upgradable to G3 **\$499**

Mac Stuff
 E-Tech 56K Bullet Modem (N) DATA FAX VOICE **\$99**

E-Tech 28.8bps (N) DATA/FAX Software Incl. **\$39** (RETAIL)
 Motorola 28.8 bps (N) DATA/FAX **\$29** (OEM)

PowerBase 240 (R)
 16/2G/16x 603e 240Mhz G3 Upgradable **\$599**

PowerCenter Pro 180 (R)
 16/2G/16x 604c 180Mhz G3 Upgradable **\$699**

PowerCenter Pro 210 (R)
 16/2G/16x 604e 210Mhz G3 Upgradable **\$799**

P5200 12/500/CD/Enet -15" MS (RC) 599.00
 PM16100-66 16/350-kybd, mouse, ethernet(I) 399.00
 PM17100-66 16/500-kybd, mouse (U) 449.00
 PM17100-80 16/500-kybd, mouse (U) 499.00
 PM17100-80 16/2G/CD kybd, mouse (U) ... 549.00
 G3 233/266/300 (R) & (U) CALL

Apple Mouse I 19 5 Port Hub ENET .. 49
 Apple Mouse II .. 29 9 Port Hub ENET .. 79
 Mouse, 1 button-N 16.50 LC-PDS ENET (N) .. 49
 Mouse, 2 button (N) .. 25 PCI-32bit ENET (N) 49
 Apple Ext Kybd II (U) 29 TranceiverENET 24.99
 Ext Keyboard (N) 29 EtherNet Cables CALL
 Alps Keyboard (N) 29 StyleWriter 1500(U) 129
 Mouse Balls (N) 5 StyleWriter 2500(U) 159
 10 pack Mouse Balls .. 35 LaserWriter Int(U) 199
 USB Hub-MacAlly .. 69 TONER ... IN STOCK
 USB Mouse-MacAlly 39 INK IN STOCK

Visit Our Online Catalog Questions? E-Mail: sales@poweron.com
www.poweron.com
 4323 Anthony Ct #1, Rosklyn CA 95677 Mon-Fri. 7a-6p PST, Sat 10-5p

All Sales Final, No Cash Refunds Given
 All Prices include 3% cash discount
 Prices subject to change without notice
 Gov't & School PO's Accepted

4 YEAR ONSITE WARRANTY from \$59.95

WE SPECIALIZE IN BUSINESS LEASING

RAM

| | |
|---------------------------------|---------|
| 16MB/32MB 72-pin Simm | 19/49 |
| 32MB/64MB 168-pin Dimm 60ns | 49/89 |
| 128MB168-pin Dimm 60ns | 199 |
| 32MB168-pin Dimm SDRAM G3 | 49 |
| 64MB168-pin Dimm SDRAM G3 | 89 |
| 128MB168-pin Dimm SDRAM G3 | 179 |
| 32MB168-pin Dimm 60NS 3.3V | 49 |
| 64MB168-pin Dimm 60NS 3.3V | 99 |
| 32MB/64MB PB G3 Series | 79/119 |
| 128MB PB G3 Series | 199 |
| 16MB/32MB PB 3400c Module 55/79 | |
| 64MB PB 3400c Module | 99 |
| 128MB PB 3400c Module | 199 |
| 24MB/32MB PB 1400 | 69/89 |
| 24MB/32MB PB 2400 | 99/119 |
| 64MB PB 2400 | 119 |
| 8MB/10MB PB 165/180 | 129/169 |
| 24MB/34MB PB 5300 | 79/89 |
| 48MB PB 5300 | 139 |
| 16MB/24MB PB 500 | 59/79 |
| 32MB PB 500 | 99 |

MICRO OUTLET
(800) 801 - 4266
 VISA MASTERCARD DISCOVER

Monitors

| | |
|---------------------------|------|
| Hitachi 17 22mm | 475 |
| Hitachi Superscan 22 21 | 1029 |
| KDS 21 28 | 699 |
| Radius PressView21SR | 2299 |
| Radius PrecView 28 21 | 1299 |
| MicroOutlet 19 25 | 469 |
| MicroOutlet 17 26 w/spkrs | 299 |
| NEC Multisync M700 17 | 539 |
| Iiyama PRO 400,17, 25dp | 495 |
| Iiyama 502 21 27dp | 995 |
| ViewSonic E651 15 28 | 169 |
| ViewSonic E771 17 27 | 299 |
| ViewSonic PT813 21,28 | 1099 |
| ViewSonic PS790 19 25 | 599 |
| Sony Multisc 500P 21.26 | 1299 |
| Sony Multisc 400PS 19 25 | 799 |
| Sony Multisc 200ES 17 | 395 |
| Sony Multisc 200GS 17 25 | 475 |
| Sony MultSc 100SF 15 25 | 250 |

Hard drives

Quantum IDE DRIVE

| | |
|-------------------------|-----|
| Stratus SE 7.6GB 9.5ms | 199 |
| Stratus SE 10.2GB 9.5ms | 309 |

Quantum SCSI DRIVE , INT ... EXT

| | |
|---------------------------|------|
| Stratus SE 4.3 9ms | 269 |
| Stratus SE 4.3 9ms | 299 |
| Atlas 4.5 8ms/7200 | 255 |
| Atlas 4.5 8ms/7200 | 299 |
| Viking II 9GBW 8ms/7200 | 479 |
| Viking II 9GBW 8ms/7200 | 529 |
| Atlas III 9GB 7.5ms/7200 | 539 |
| Atlas III 18.2GB 7.5ms/72 | 999 |
| Atlas III 18.2GB 7.5ms/72 | 1050 |

Scanners

| | |
|----------------------------|---------|
| Umax Astra 1220U 600 dpi | \$149 |
| Umax 1200s, Full Photoshop | 399 |
| Umax Astra 610S 30-bit | 109 |
| AGFA Arcus II Bundle | \$ 1099 |
| AGFA SnapScan 600 Artline | 419 |
| AGFA SnapScan 1236s | 235 |
| Microtek Scanmaker V600 | 115 |
| Microtek Scanmaker V310 | 69 |
| Microtek Scanmaker Ph/Tran | 2199 |

Printers

| | |
|------------------------------|------|
| Epson Stylus Color Photo EX | 449 |
| Epson Stylus Color Photo 800 | 219 |
| Epson Stylus Color 850 | 295 |
| Epson Stylus Color 850N | 295 |
| Epson 1520 | 449 |
| Epson 3000 | 1150 |
| HP DeskJet 1600CM | 1899 |
| HP LaserJet 6MP | 859 |
| HP LaserJet 4MV 16ppm | 1499 |
| HP Color LaserJet 5M | 4799 |
| Newgen Design NXP Tabloid | 1799 |
| GCC Elite 12/600 Dpi | 999 |
| GCC Elite XL 1208,1200Dpi | 2399 |

Video Cards

| | |
|----------------------------|-------|
| Radius EditDV/FireWire | \$699 |
| TrueVision Targa 1000 | 1399 |
| ATI XClaim 3D RAGE PRO 8MB | 229 |
| IXMICRO PROREZ 8MB | 269 |

Modems

| | |
|---------------------------|-----|
| Supra Express 56k V90 | 109 |
| Supra 56k, PCMCIA Pbook | 149 |
| Zoom 33.6 fax/modem, Ext. | 79 |
| G.V. Teleprt 56k V90 | 125 |

(800) 801-4622 • www.microoutlet.com • fax: (310) 533-7098

MAC BASE
800-951-1230
MACBASE.COM

Int'l (714) 428-0777 University, School, Gov. & Fortune 1000 P.O.'s Accepted! FAX (714) 428-0778

NEW SYSTEMS

| | |
|----------------------------|------|
| NEW! G3MT/333 128/9UW/CD | 2899 |
| NEW! G3MT/300 64/8G/CD/ZIP | 2299 |
| NEW! G3DT/300 64/6G/CD/ZIP | 1899 |
| G3 DT/233 32/4G/24XCD | 1299 |
| G3 DT/266 32/4G/24X/ | 1449 |
| G3 DT/266 32/4G/24X/Zip | 1549 |
| 4400/200 PC COMPATIBLE | 999 |
| 5400/180 16/2G/CD | 849 |
| 8600/300 32/2G/CD/ZIP | CALL |
| 9600/300 64/4GB/24XCD/ZIP | CALL |
| 9600/350 64/4GB/24XCD/ZIP | CALL |

NOTEBOOKS

| | |
|-----------------------------|------|
| G3/233 32/2G/CD/12.1 TFT | 2059 |
| G3/233 32/2G/CD/14.1 TFT | 2599 |
| G3/266 64/4G/CD/14.1 TFT | 3299 |
| G3/300 64/8G/DVD/14.1 TFT | CALL |
| G3/233 32/2G/20XCD/12.1 STN | 1799 |
| G3/250 32/4G/20X/MDM TFT | 2999 |
| 1400C 133 or 166 | CALL |
| DUO DOCK II PLUS | 179 |
| EMATE 300 / NEWTON | CALL |
| 540C 20/500/MDM | CALL |

REFURBISHED

| | |
|---------------------------|------|
| PB 1400C 16/1.3GB/CD | 1259 |
| PB 3400C/180 16/1.3G/CD | 1459 |
| PB 3400C/200 16/2G/CD | 1649 |
| PB 3400C/240 16/3G/CD | 1749 |
| 6360 16/1.2G/CD | 649 |
| 6400/180 16/1.6/CD | 659 |
| PM 5500/225 32/2G/CD | Call |
| PM 8600/300 32/4G/CD/ZIP | Call |
| PM 9600/300 64/4G/24X/ZIP | Call |
| Apple 15AV | 269 |
| Color Stylewriter 4500 | 219 |
| Color Stylewriter 6500 | 269 |
| LaserWriter 12/640 | 799 |
| LaserWriter 8500 | 1399 |

RECONDITIONED

| | |
|------------------------|------|
| PM 7200/75 8/500/CD | 359 |
| PM 7200/90 8/500/CD | 449 |
| PM 7600/132 16/1.2G/CD | 799 |
| PM 8500/150 16/1G/CD | 899 |
| PM 9500/233 16/2G/CD | 1199 |
| PM 8100/110 16/1G/CD | 629 |
| PM 8100/100 16/1G/CD | 549 |
| PM 7100/80 8/500/CD | 399 |
| PM 6100/60 8/230/CD | 319 |

1000'S OF PRODUCTS IN STOCK. CALL US FOR LATEST PRICING!

FedEx
 * indicates refurbished product. MacBase is not an Authorized Apple Dealer. Returns subject to restocking fee. Prices reflect C.O.D. or CASH and are subject to change without notice. P.O.'s subject to approval. All trademarks are property of their respective companies.

Sales: 818-787-3509

6735 Van Nuys Blvd. Van Nuys, CA 91405

e-mail: csales@pacificnet.net



0199

Fax: 818-787-5555

Visit Our Site for Daily Specials

Apple, MAC, iMac, PowerMac, & PowerBook, are registered trade marks of Apple Computers Inc.

All prices are subject to prior sale & subject to change without notice!



* = Factory Refurbished



PowerMacs

- iMac G3/233 32/4GB, 24xCD, USB, 15" AV \$1195
- G3/333 Tower 128/9GB U-W, 24xCD ... \$2495
- G3/300 Tower 128/9GB U-W, CD, Zip, AV ... \$2395
- G3/300 Tower 64/4GB, 24xCD, Zip, AV ... \$1995
- G3/300 Desktop 64/6GB, 24xCD, Zip ... \$1595
- G3/300 Desktop DVD 64/4GB, Zip ... \$1695
- G3/266 Desktop 64/4GB, 24xCD ... \$1295
- 9600/300 64/4GB, 24xCD, Kb., Zip ... \$2395
- 8600/300 64/4GB, 24xCD, Kb.* ... \$1395
- 4400/200 64/2GB, 12xCD, 256K Cache ... \$695
- 4400/200DOS 64/2GB, 12xCD, 256K Cache \$795
- 14"/15"/17" Monitor w/Purchase ... \$89/129/249

DOS Card PC166MHz-----\$195
16MB RAM, 2MB Video, DOS 6.22, Win.95

Faster Macs... Hot Deals
www.appledeals.com

SOFTWARE



Adobe

- Photoshop 5.0 / Illustrator 7.0 ... \$499/389
- PageMaker 6.5 / Acrobat 3.0.1 ... \$379/159
- PageMILL 3.0 / StreamLine 4.0 ... \$89/129
- Dimension 3.0 / Premiere 4.2 ... \$129/279
- Premiere 4.2/ After Effects 3.1 ... \$289/399
- After Effects Prdctn. Bndl. \$1499

Quark

- QuarkXpress 4.0 \$687



MetaCreations



- Painter 5.0 ... \$229
- Painter 3D ... \$459
- Expression ... \$189
- Bryce 3D ... \$159
- Kai's PowerTools 3.0 ... \$95



Microsoft

- Office 98 MAC \$349
- Excel 98 MAC \$179
- Word 98 MAC \$159

Memory

Great Value!

- 32/64MB DIMM \$39/75
- 128/256MB DIMM ... \$165/380
- 64MB PowerBook Wall Street .. \$99
- 128MB PowerBook Wall Street \$175

www.appledeals.com

Toll Free 1-800-816-7307

PowerBooks



- G3/300 DVD 64/8GB, DVD, 56K, 14.1" .. \$3995
- G3/292 64/8GB, 20xCD, 56K \$3595
- G3/266 64/4GB, 20xCD, 56K, 14.1" TFT ... \$2999
- G3/250 64/4GB, 20xCD, 56K \$2695
- G3/233 64/2GB, 20xCD, 56K, 14.1" TFT ... \$2295
- G3/233 64/2GB, 20xCD, 12.1" TFT \$1795
- 3400c/240 64/3GB, CD, 10BT, 33.6" \$1495
- 3400c/200 64/2GB, CD, 10BT, 33.6" \$1295
- 1400c/133 32/1GB, 8xCD* \$1075
- 5300cs/100 & Duo 2300c .. \$595*/685*
- 5300cs/100* 32/500MB, Free Batt./MDM \$695*
- Duo 2300c 40/2.1GB, w/1h Floppy/Adptr. .. \$995*
- Duo Floppy / Adapter \$175
- Battery f/PB. 5300 Series \$29
- Trade-in Your PowerBook. .CALL 818-609-0466

Video & Graphic Cards/CD-R Drives

- Panasonic 4x8 CD-R Int. .. \$249
- Yamaha 2x4x6 Int. \$349
- IO Pack Blank CDR Media ... \$12



IXMICRO

- Twin Turbo 128M4/128MB ... \$239/329
- ix 3D Ultimate Rez \$435
- ix 3D Pro Rez \$249

If you want the best prices and service around, call us today!

BUY/SELL/TRADE

MediaGuide

Prices Listed Reflect a 3% Cash Discount

BUY/SELL/TRADE

SUPER SPECIALS!!

Apple 730mb 3.5" SCSI HD...\$79

New Global Village modems:

- Powerbook 1xx 14.4.....\$39
- Powerbook 1xx 28.8.....\$99
- Powerbook 5xx 19.2.....\$59

FWB SCSI-II Jackhammer PCI...\$199
(SCSI throughput up to 40mb/sec)

Duo 280c 40/750/14.4.....\$649
Duo Dock (w/color lid).....\$99

BUNDLE SPECIALS

(Listed CPU plus an Apple 13" RGB, KB, mouse)

- Ilci 8/80...\$199 Ilsi 9/80...\$199
- Ilcx 8/80...\$179 Ilvx 8/80...\$229
- Centris 610 8/730.....\$299
- Quadra 630 20/2gig.....\$349
- Quadra 650 16/730.....\$429

OLDER MACS

- Mac Plus 4/0.....\$49
- SE FDHD 4/40.....\$89
- SE/30 8/80.....\$129
- Mac II 4/40/Video...\$39
- Ilcx 8/40/Video.....\$79
- LC II 10/80.....\$89
- Ilci 8/80.....\$99
- Ilvx 8/160.....\$119

QUADRA & CENTRIS

- Perf 475 8/230.....\$189
- Q605 8/230.....\$199
- Q630 8/250.....\$249
- Q650 16/500.....\$349
- Q800 16/500.....\$379
- Quadra 660AV 16/500/CD.....\$399
- Quadra 840AV 16/500/CD.....\$499

POWER MACS

- 6100/60 8/500/CD/DOS.....\$499
- 7100/66 8/500/CD.....\$459
- 7100/80 8/500/CD.....\$499
- 8100/80 8/500/CD.....\$549
- 7200/75 8/500/CD.....\$499
- 7200/90 8/500/CD.....\$549
- 7500/100 16/1gig/CD.....\$699
- 8500/120 16/2gig/CD.....\$799
- Many other Power Macs in stock....CALL!!

POWERBOOKS

- PB 140 4/40.....\$199
- Powerbook 160 8/80/14.4.....\$399
- Powerbook 165 12/120/14.4.....\$449
- Powerbook 165c 12/120/14.4.....\$499
- Powerbook 180 8/120/14.4.....\$499
- Powerbook 180c 14/160/14.4.....\$599
- Powerbook Duo 230 12/160/14.4.....\$199
- Powerbook Duo 270c 12/240/14.4.....\$399
- Powerbook 520 12/240/19.2.....\$529
- Powerbook 520c 12/240/19.2.....\$599
- Powerbook 540c 12/320/19.2.....\$699
- Powerbook 1400's & 3400's....BEST PRICES!

MONITORS

- Apple 12" Mono...\$79
- Apple 12" RGB...\$99
- Apple 13" RGB...\$149
- Apple 14"....\$179
- Apple 15" MS...\$249
- Apple 16" RGB...\$279
- Apple 17" MS...\$349
- Third Party....\$CALL

PRINTERS

- Imagewriter II.....\$99
- Laserwriter II.....\$99
- Laserwriter IIInt...\$199
- Laserwriter IIIntx.....\$249
- Laserwriter IIIntx.....\$249
- Laserwriter IIIntx.....\$399
- LW Pro 630...\$699
- LW 16/600.....\$899
- Laserwriter Pro 810.....\$999
- Super Match Dye Sub printer.....\$499
- HP Deskjet 1600c (new).....\$999
- HP Deskwriter (no ink).....\$79

MISCELLANEOUS

- New Sony 24x external CD-ROM.....\$169
- Apple 2x tray-loaded CD-ROM (int).....\$49
- Apple 730mb 2.5" Powerbook SCSI HD...\$249
- New external HD case w/cable.....\$49
- 256K L2 cache for 6100/7100.....\$9
- 6100 486/66 DOS card (w/cable & sw).....\$49
- Syquest Cartridges 44/88/200.....\$9/\$19/\$49
- Ilsi NuBus adaptor w/FPU.....\$29
- Curtis CommandCenter Plus Surge Prot...\$49
- 1MB 30-pin SIMM...\$5
- 4MB 30-pin SIMM...\$15

SOFTWARE

- MS Excel 4.0.....\$39
- MS Office 4.2.1...\$99
- MS Office '98...\$249
- QuickKeys 3.0.....\$10

POWERBOOK ACCESSORIES

- Powerbook video cable.....\$25
- Powerbook HDI29 to DB25 SCSI adaptor...\$29
- Powerbook 5xx internal floppy drive.....\$99
- Powerbook 1xx battery charger.....\$19
- Powerbook Nylon carrying case.....\$19
- Powerbook Leather carrying case.....\$59
- Powerbook Duo floppy drive.....\$119
- Color Lid upgrade for Duo Dock.....\$29
- Duo Dock power supply.....\$49
- Apple 14.4 modem for PB Duo.....\$79
- Logic boards, Power supplies, RAM — CALL!
- Parts, Accessories, other CPUs — CALL!

Toll free: (888) 466-2271

Fax: (303) 571-5020 • Local & Int'l: (303) 571-1900 • Hours: M-F 8-6, SAT 10-5 MST • 777 N. Santa Fe Dr., Denver, CO 80204
Sales E-mail: Sales@MediaGuide.com • Purchasing E-mail: Purchasing@MediaGuide.com • <http://www.mediaguide.com>

voice: 925-689-9488 fax: 925-689-9487

PRICES & QUANTITIES SUBJECT TO CHANGE

Place Your Orders OnLine!

1-888-447-3728 • MacResQ • www.macresq.com

Toll Free
Mac OS
software
8.0: \$39
(both on cd)
7.6: \$39
w/ Claris
Works 4.0

PARTS, PARTS, PARTS!!

| | |
|---------------------------------------|-----------------|
| CyberDrive 24x internal CD Rom | \$89 |
| Toshiba 32x internal CD Rom | \$119 |
| Manual inject floppies (661-0121)exch | \$59 |
| Auto inject floppies (661-0474)exch | \$49 |
| PB 100 & 500 series floppies-exch | \$89 |
| PM 6100 DOS cards | \$39 |
| 3Jtech Pegasus 56k Palm-size modem | \$99 |
| Apple Extd. II keyboard | \$29 |
| Apple ADB II mice | \$19 |
| FENTON UPS Systems | call for \$\$\$ |

APPLE MONITORS

| | |
|---------------------|-------|
| 14" Basic Color VGA | \$99 |
| 14" Performa Plus | \$129 |
| 14" Multi-scan | \$149 |
| 15" Multi-scan | \$199 |
| 16" RGB Display | \$199 |
| 17" Multi-scan | \$299 |
| 1705 Display | \$349 |
| 1710 Display | \$399 |
| 20" Multi-scan | \$799 |
| 21" Color Display | \$499 |

PowerBook Screen EXCHANGE

| | |
|--------------------------|-------|
| PB 140/145/160/165/165cl | \$199 |
| 520/540 | \$249 |
| PB 5300cs/190cs/180c | \$299 |
| PB 5300ce/270c/280cl | \$299 |
| 2300c | \$299 |

SAME MODEL EXCHANGE-NOT AN UPGRADE
+\$65 for installation
+\$100 for a CRACKED screen

POWER SUPPLIES(EXCH. ONLY)

| | |
|--------------------------|-------|
| LC thru Q 605 | \$19 |
| Mac II cx / ci / Q 700 | \$49 |
| Q 800 / PM 8100 | \$99 |
| PERF. 6360 | \$89 |
| Duo Dock | \$49 |
| Q 900 / 950 | \$99 |
| PM 7100 | \$69 |
| PM 6100 | \$89 |
| II SI | \$29 |
| PM 8500-9500 / 8600-9600 | \$149 |

Apple
StyleWriter
1200's
\$119
MR
Mac-Res-Q.

Apple **1.2 Gig Hard Drives**
Mac OS (Quantum, internal, 3.5", SCSI) **\$99**

Internal APPLE CD Rom Drives *
*Internal Mounting kit: \$25 *External Model: \$60
(face plate, audio cable, sled) (installed w/ cables)

| | |
|------------------------|------------------------|
| CD 300i+ (2x) \$39-R | CD 1200i (8x) \$99-N |
| CD 600i (4x) \$79-N | CD 1800i (12x) \$149-N |
| CD 3600i (24x) \$169-R | |

15% re-stocking fee- ALL ITEMS REFURBISHED UNLESS NOTED AS NEW • All Parts Sold With a 90 Day MacResQ Exchange Warranty • Exch. Required For ALL Power Supplies • All Major Credit Cards With NO Surcharge.

www.PowerBook1.com

Secure Online Ordering!

POWERBOOK PRODUCTS

MCE

PowerBook Drives

For use in PB 3400, 2400, 1400, 5300, 190, 150 & Duo 2300

| | | | | |
|------------------|--------|---------|--------|-----|
| MobileStor 2100t | 2.1 GB | TOSHIBA | \$ 199 | 3yr |
| MobileStor 3200h | 3.2 GB | HITACHI | \$ 269 | 3yr |
| MobileStor 4000i | 4.0 GB | IBM | \$ 309 | 3yr |
| MobileStor 4300i | 4.3 GB | IBM | \$ 319 | 3yr |
| MobileStor 5400i | 5.4 GB | IBM | \$ 399 | 3yr |
| MobileStor 6400i | 6.4 GB | IBM | \$ 539 | 3yr |
| MobileStor 6400t | 6.4 GB | TOSHIBA | \$ 539 | 3yr |
| MobileStor 8000i | 8.0 GB | IBM | \$ 749 | 3yr |

IX MICRO Road Rocket
24bit Video Output for PB G3 series
ONLY \$299

MCE PC Card Diskoper
Use our PC-card case for your original IDE drive and save your megabytes
ONLY \$129

VST PRODUCTS

PowerBook Drives

| | Zip Drive | Super Disk | Charger | Battery | Airto Adapter |
|---------------|-----------|------------|---------|---------|---------------|
| PB 1400 | \$219 | \$99 | \$119 | \$79 | |
| PB 5300/190 | \$239 | \$149 | | | |
| PB 3400 | \$239 | \$149 | \$149 | \$79 | |
| NEW G3 Series | \$249 | \$219 | \$159 | \$199 | \$78 |

All MCE PowerBook hard drives include the **MCE PB Hard Drive Supplemental Kit** which includes an installation manual, torx tool*, mounting bracket*, driver software* and anti-static wrist strap.
*as needed

newertech

| | |
|------------------------------|----------|
| NUpowr 1400/G3 250MHz | - \$ 979 |
| NUpowr 1400/G3 216MHz | - \$ 689 |
| NUpowr 2400/G3 240MHz | - \$ 829 |
| VIEWpowr 1400 (16-bit video) | - \$ 239 |
| Bookendz Dock for 34/24/1400 | - \$ 179 |

MCE powrUP 1400/G3 Bundle:
Includes: NUpowr 1400/G3 250MHz/1MB cache & IBM 4.0 GB 2.5" IDE HD **\$ 1329**

MEMORY

Apple Recommended

Viking Components

| | 32MB | 48MB | 64MB | 128MB |
|--------------|-------|-------|-------|-------|
| PB G3 Series | \$99 | \$119 | \$149 | \$239 |
| PB G3 (3600) | \$119 | \$159 | \$199 | \$259 |
| PB 3400 | \$119 | \$169 | \$199 | \$329 |
| PB 2400 | \$99 | | \$149 | |
| PB 1400 | \$119 | \$189 | | |
| PB 5300 | \$119 | \$149 | | |
| PB 190 | \$119 | | | |
| PB 520/540 | \$119 | | | |
| Duo 2300 | \$119 | | | |

MCE Xcarét Media Bay Hard Drives
PB 3400, 3500, 5300, 190; Xcarét Pro for PB G3 Series

| | 6GB | 4GB | 2GB | 0GB |
|--------------|-------|-------|-------|-------|
| Standard/Pro | \$559 | \$399 | \$319 | \$149 |

Kritter Cam \$249
CapSure Card \$129
640x480, 30fps
Video for 3400/2400/G3

MadsonLine AC adapter
for PB 3400, G3, 2400 & 1400
only \$85
half the size/weight of Apple's adapter!

Viking Components
56K v. 90 PCMCIA FaxModem \$99

World's Smallest External
56K v. 90 FaxModem, no power supply needed
\$119

Introducing The "Flip Disk"

High capacity, portable storage for your PowerBook...
Just plug it in & it works!

Flip Disk

| | |
|---------------|-------|
| Flip 20 (2GB) | \$449 |
| Flip 40 (4GB) | \$579 |
| Flip 60 (6GB) | \$749 |

Type II PC Card

30 Hughes Suite 203 • Irvine, CA • 92618
Visa / MC / AmEx / Discover / P.O.'s

1-800-5000-MAC • 949-458-0800 • fax 949-458-1803

Macworld | **Get**



www.macworld.com/getinfo

Macworld's NEW Online Reader Service

THE ULTIMATE UPGRADE!

G3

SONNET
SIMPLY FAST™

**3 Year Warranty!
Free Technical
Support!**

Macworld
EDITORS'
CHOICE

MAC
ADVERTISER
RATED
5/17
PRAKIN' AWESOME!
www.macad.net

Rating
★★★★
Mac Reviews
★★★★
MacHome

MacDirectory
Best Buy
Crescendo G3
★★★★
MacWEEK Review

Fastest G3 Available for Your 6100/7100/8100 Power Mac!

Installing a Sonnet™ Crescendo™ G3 processor upgrade card into the PDS slot of your Power Mac is "plug-and-play" and will match the performance of a new G3 system.

- Universal card – works in 6100, 7100, and 8100
- 100% software compatible
- 665-1047% overall speed improvement
- Auto-configures to highest possible processor speed
- Use existing video card in 71/8100 with Adapter Kit or 71/8100 NuBus video card – millions of colors up to 1152x870



300 MHz!

G3 Speed Up To 400 MHz for Your PCI Power Mac!

In minutes, remove your old CPU card and replace it with a Sonnet G3 processor upgrade card.

- 100% software compatible
- 400-800% overall speed improvement
- Consistently best values
- Plug-and-play installation



400 MHz!

NEW! 366 MHz Upgrade for Power Mac G3 Desktop or Tower!

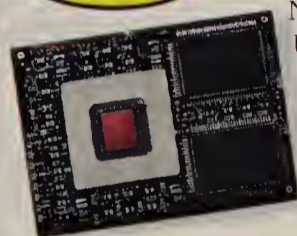

Need more speed from your G3 Power Mac? Upgrade it with Sonnet's 366 MHz Encore G3 processor card – performs up to 165% faster!

- Works in Power Mac G3 Desktop/Tower
- 100% software compatible
- Simple installation

Presto 040 Processor Upgrades for 68030 Macs

Increase the performance of your Mac up to 550% with this super-fast 68040 upgrade card and run Mac OS 8.1! The Presto includes 128K level 2 cache and can be configured with an FPU for fast math calculations.

| Power Mac 6100/7100/8100/8115 • Wrkgrp Svr 6150/8150/9150 Performa 6100-6118 • Radius 81/110 | |
|---|---------------------|
| Crescendo G3 233/117 MHz/512K Cache (except 6100AV) | \$399 ⁹⁵ |
| Crescendo G3 233/117 MHz/512K Cache (6100AV only) | \$449 ⁹⁵ |
| Crescendo G3 266/133 MHz/1MB Cache (except 6100AV) | \$599 ⁹⁵ |
| Crescendo G3 300/150 MHz/1MB Cache (80 or 110 MHz Macs) | \$799 ⁹⁵ |
| Video Options and Adapters | |
| 7100 PDS AV/Video Adapter Kit | \$99 ⁹⁵ |
| 8100 PDS AV/Video Adapter Kit | \$99 ⁹⁵ |
| 71/8100 Sonata Pro 24 NuBus Video Card (up to 1152x870) | \$199 ⁹⁵ |

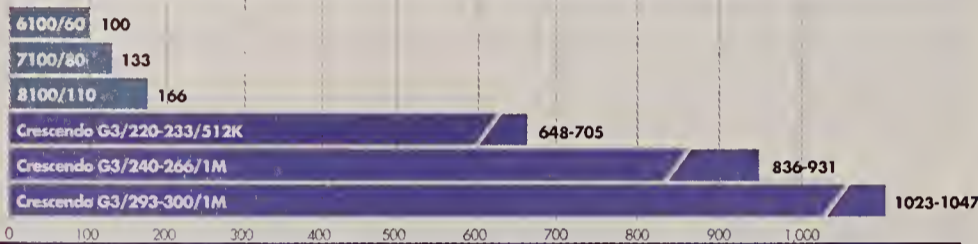

| Power Mac 7300/7500/7600/8500/8515/8600/9500/9515/9600 Wrkgrp Svr 7350/8550/9650 • PowerWave • UMAX J700/S900 | |
|--|----------------------|
| Crescendo G3 233/117 MHz/512K Cache | \$349 ⁹⁵ |
| Crescendo G3 266/133 MHz/1MB Cache | \$599 ⁹⁵ |
| Crescendo G3 300/150 MHz/1MB Cache | \$799 ⁹⁵ |
| Crescendo G3 333/167 MHz/1MB Cache | \$999 ⁹⁵ |
| Crescendo G3 366/183 MHz/1MB Cache | \$1199 ⁹⁵ |
| Crescendo G3 400/200 MHz/1MB Cache | \$1699 ⁹⁵ |

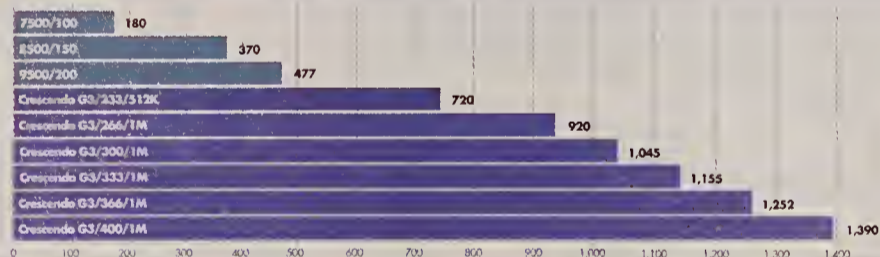

| Power Mac G3 Desktop or Tower | |
|---------------------------------|----------------------|
| Encore G3 333/167 MHz/1MB Cache | \$999 ⁹⁵ |
| Encore G3 366/183 MHz/1MB Cache | \$1199 ⁹⁵ |

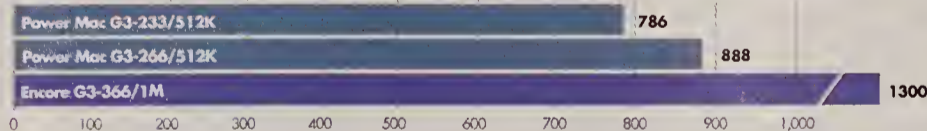

| Mac Ilci/Ilcx*//lsl*/llvi/llvx • Performa 600 | |
|---|---------------------|
| Presto 040 80/40 MHz 68LC040/128K Cache | \$199 ⁹⁵ |
| Presto 040 80/40 MHz 68040/128K Cache/FPU | \$299 ⁹⁵ |
| * Adapter required for Ilcx, llsi | \$49 ⁹⁵ |

Sonnet Technologies, Inc.
18004 Sky Park Circle, Irvine, CA 92614
Tel: 949-261-2800 Fax: 949-261-2461
E-mail: sales@sonnettech.com

800-786-6260
<http://www.sonnettech.com>



Booth #3951
Moscone
Convention Center
San Francisco
January 5-8, 1999



Visa, MasterCard and American Express no surcharge. Government, corporate and education P.O.s welcome. Sonnet products are covered by a three-year limited warranty. Prices are subject to change without notice. Returns require an authorization and are subject to a restocking fee. Sonnet, the Sonnet logotype, Crescendo, and the Simply Fast logotype are trademarks of Sonnet Technologies, Inc. ©1998 Sonnet Technologies, Inc.

MACINTOSH MEMORY UPGRADES

| YOUR MACHINE | 4MB | 6MB | 8MB | 10MB | 12MB | 16MB | 20MB | 24MB | 32MB | 48MB | 64MB | 128MB | 256MB |
|---|-----|-----|-----|------|------|------|------|-------|-----------|------|------------|------------|------------|
| Apple PowerBook G3 & Wallstreet | | | 59 | | | 56 | | | 79 | 109 | 139 | 269 | 899 |
| Apple PowerBook 180, 165, 165C, 180, 180C, 190, 190CS | 99 | 139 | 169 | 219 | | | | | | | | | |
| Apple PowerBook 520, 520c, 540, 540c Notebook | | | | | 69 | 59 | | | 80 | 99 | | | |
| Apple PowerBook DUO 210, 230, 250, 270c, 280, 280c Notebook, 2300c/100 Notebook | | | | | 49 | | 81 | 28=99 | 36=139 | | | | |
| Apple PowerBook 1400, 2400, 3400C EDO, 5300 Series | | | | | | | | 59 | | 99 | 129 | 179 | |
| Apple Macintosh IIsi | 10 | | | | | 60 | | | | | | | |
| Apple Macintosh IIfx (64 pin), IIfx & IIfv | 28 | | | | | 88 | | | | | 356 | | |
| Apple Macintosh Classic II, LC, LCII | | | 30 | | | | | | | | | | |
| Apple Macintosh LCIII, LC475, LC550, LC575, LC580, LC499, LC520, LC580, LC630, LC5200 | 8 | | 19 | | | 32 | | | 49 | | | | |
| Apple Macintosh II, IIfx (w/Pal) | 48 | | 109 | | | 96 | | | | | 298 | | |
| Apple Macintosh SE30 | 20 | | | | | 79 | | | | | 298 | | |
| Apple Performa 400, 405, 410, 430 | 20 | | 30 | | | | | | | | | | |
| Apple Performa 450, 460, 466, 467, 475, 476, 550, 560, 575, 577, 578, 580 | 8 | | 19 | | | 29 | | | 49 | | | | |
| Apple Performa 6110CD, 6112CD, 6115CD (pairs), 6117CD, 6118CD (pairs) | 8 | | 19 | | | 29 | | | 49 | | | | |
| Apple Performa 630, 630CD, 631CD, 635CD, 636, 636CD, 637CD, 638CD, 640CD | 8 | | 19 | | | 29 | | | 49 | | | | |
| Apple Performa 5200 Series 5200CD, 5215CD, 5300, 6100 Series 6116CD (pairs) | 8 | | 19 | | | 29 | | | 49 | | | | |
| Apple Performa 6200 Series 6200CD, 6216CD, 6218CD, 6220CD, 6230CD, 6290 | 8 | | 19 | | | 29 | | | 49 | | | | |
| Apple Performa 6205CD, 6214CD, 6300CD, 6320 | 8 | | 19 | | | 29 | | | 49 | | | | |
| Apple Performa 6400CD, 6360 (2K Refresh) | | | | | | 29 | | | 49 | | 99 | | |
| Apple Centris 610, 650, 660 AV | 8 | | 19 | | | 29 | | | 49 | | | | |
| Apple Quadra 605, 610, 630, 650, 660AV, 800 (pairs), 840AV | 8 | | 19 | | | 29 | | | 49 | | | | |
| Apple Quadra 700, 900, 950, Apple Performa 600, 600CD | 8 | | 19 | | | 29 | | | 49 | | | | |
| Apple iMac (SDRAM) | | | | | | | | | 79 | | 149 | 279 | |
| Power Macintosh G3 (all models) | | | | | | | | | 39 | | 99 | 199 | 659 |
| Power Macintosh 4400/160, 5200, 5260, 5300, 5400, 6400/200, 6500/225, /250, /275, /300 (Edo) | 8 | | 19 | | | 29 | | | 49 | | | | |
| Power Macintosh 6200/75, 6100/60, 6100/66, 6100/66AV (pairs) | 8 | | 19 | | | 29 | | | 49 | | | | |
| Power Macintosh 7100/66, 7100/80, 7100/66AV (pairs) | 8 | | 19 | | | 29 | | | 49 | | | | |
| Power Macintosh 7200/75, /90, /120, /120PC, 7300/166, /180, /200, 7500/100, 7600/100, /120, /132, /200 | | | | | | 29 | | | 49 | | 99 | | |
| Power Macintosh 8100/80, /100, /110, 8100/80AV, /100AV, /110AV (pairs) | 8 | | 19 | | | 29 | | | 49 | | | | |
| Power Macintosh 8500/120, /132, /150, /180, 8600/200, /233, 9500/120, /132, /150, /180MP, 200, 9600/200, /233, /200MP | | | | | | 29 | | | 49 | | 99 | | |
| Color Laserwriter 12/600 PS, 12/640 PS, 16/600 PS | 16 | | | | | 29 | | | | | | | |

WE ALSO BUY BACK YOUR OLD MEMORY CALL FOR QUOTE.

The Memory Liquidators, Inc.
 (800) 718-7755
 www.memoryliquidators.com or E-mail: sales@memoryliquidators.com
 531 Main St., El Segundo, CA 90245 Ph. 310-326-5656 • Fax 310-326-7790 • M-F 7 to 5; Sat. 8 to 12 noon PST
 • Secure Web Site • Prices subject to change without notice • 20% restocking fee on all returns.

Lifetime Warranty on all Memory
Gov't & Educational P.O.'s & Credit Cards

POWER COMPUTING/MOTOROLA

| | | | | | | | |
|-------------------------|--------|-------|-------|-----------------------------------|--------|-------|-------|
| POWER 80, 100, 110, 120 | 16 MEG | 32MEG | 64MEG | POWER TOWER PRO 200, 225 | 16 MEG | 32MEG | 64MEG |
| POWER CENTER 120, 132 | 29.00 | 49.00 | 99.00 | POWER WAVE 604/120 | 29.00 | 49.00 | 99.00 |
| POWER CENTER 150, 166 | 29.00 | 49.00 | 99.00 | POWER WAVE 604/132, 150 | 29.00 | 49.00 | 99.00 |
| POWER CENTER 180 | 29.00 | 49.00 | 99.00 | POWER BASE (EDO) | 29.00 | 49.00 | 99.00 |
| POWER CURVE 601/120 | 29.00 | 49.00 | 99.00 | | | | |
| POWER TOWER 160/130 | 29.00 | 49.00 | 99.00 | MOTOROLA STARTRAX 3000 | | | |
| POWER TOWER PRO 180 | 29.00 | 49.00 | 99.00 | EDO/160, 200: 4000/160, 200 29.00 | 49.00 | 99.00 | |

APPLE POWERBOOK BATTERIES

| | | | |
|---|--------|--|--------|
| Powerbook 140, 145, 150, 160, 165, 170, 180 | 69.00 | Powerbook 2300, 520, 520C, 540, 540C | 123.00 |
| Powerbook 1400, 190, 190CS, 3400, 5300 | 133.00 | Powerbook DUO 200, 210, 230, 250, 270, 280 | 112.00 |

CHECK OUT OUR WEBSITE FOR MORE APPLE BATTERIES!!!

NO SURCHARGE FOR MASTERCARD, AMEX, VISA OR DISCOVER. PURCHASE ORDERS ACCEPTED FROM FORTUNE 2000, GOVERNMENT & INSTITUTIONS. California orders add 8.25% sales tax. Returned orders or ordered wrong parts are subject to a 20% restocking fee. We accept international orders shipped via UPS Air, APO, FPO orders welcome. Customers are expected to pay customs and "other" charges if shipped Int'l. All credit card charges verified for fraudulent use. SORRY, No Returns after 30 Days - Exchanges Only. If you receive defective merchandise we exchange only—no returns. We accept MC, VISA, Discover, AMEX, prepared orders, purchase orders, wire transfer, ODO (cashiers check), cash & cashiers checks. Orders shipped by UPS. FedEx must be signed for. *All manufacturers part #'s are for ref only - Min. Order \$40 - *No refunds on shipping.

Great Deals on USED MACS

Check It Out!

| | | |
|---------------------|--------------------|--------|
| 8500/120 | 16/1gb/CD | \$ 850 |
| 6400/180 | 16/2gb/8x/28.8 | 625 |
| 7200/90 | 8/500/CD | 600 |
| 7200/75 | 8/500/CD | 550 |
| 7100/66 | 8/500/CD | 525 |
| 6100/60 | 8/230 | 350 |
| PwrBook G3/266 14.1 | 64/4gb/20x/56k | 2,850 |
| PwrBook 3400c/180 | 16/1gb/8xCD refurb | 1,375 |
| PwrBook 1400c/117 | 16/1gb/6xCD refurb | 1,125 |
| PwrBook 1400cs/117 | 12/750 refurb | 900 |

Prices subject to change. Limited to stock on hand, subject to prior sale. Call for up-to-the minute inventory & prices. 1023

WE BUY, SELL & TRADE MACS!

www.macsolutions.com

MAC Solutions Authorized Value-Added Reseller Service Provider

(800) 80-WE-BUY

MEMORY

ABSOLUTELY, POSITIVELY, THE BEST PRICES!
 Plus, Lifetime Warranty on all RAM!

| | | | |
|-------------------------------|-------------------------|---------------------|------------------------------|
| *iMAC & PB G3 RAM* | PowerBook Memory | Cache/VRAM | SIMMs 72 & 30 pin |
| 16mb \$ 52 | 32/64 G3/3400 \$ 66/101 | 44/64/54 512k \$ 35 | 72 16mb/32mb \$ 30/60 |
| 32mb 88 | 128 G3/3400 188 | 61/7100 256k 10 | 72 64mb 127 |
| 128 mb 176 | 16/24/32 1400 43/58/74 | 72/76 256k 37 | 30 4mb/16mb 9/28 |
| SDRAM-In Stock! | 32/48 5300 74/98 | 72/76/85 512k 52 | Storage Specials |
| 64mb \$ 85 | 16/32 500 40/70 | 73/76/85/86 1mb 94 | Quantum 3.2 gb SCSI \$ 225 |
| 128mb 168 | 168 Pin DIMMs | 1 mb VRAM 17 | Qntm Atlas 9.1 gb SCA 400 |
| 256mb 448 | 16/32 mb \$ 23/50 | 4mb G3 VRAM 20 | Jaz Carts 1 & 2 gb (each) 80 |
| | 64/128 mb 128/230 | | |
| | 64 mb 3.3v/EDO 91 | | |

All prices are subject to change. Not responsible for typographic errors. Limited to stock on hand.

WE'LL BEAT ANY PRICE!*

Order Online — www.macsolutions.com
 11933 Wilshire Blvd, West Los Angeles, CA 90025
 Fax: (310) 966-4433
 University & School P.O.'s Welcome . Ad code #1023
 VISA-Discover/MC-AMEX no surcharge

PRINTER & PC/LAPTOP MEMORY IN STOCK - CALL !!

(800) 873-3RAM

MAC Solutions

800-WE-FIX-MACS

THE ONLY NUMBER FOR ALL MACINTOSH PARTS

- 🍏 Free Diagnostics
- 🍏 24 Hour Turnaround
- 🍏 Longest Warranties
- 🍏 Largest Inventory of Parts
- 🍏 Advance Exchanges

 **PowerComputing**
specialists

2202 N. FIRST STREET, SAN JOSE, CA 95131 • 800 933-4962 • www.allmac.com

DATA RECOVERY: 800-440-1904

7 good reasons to choose DriveSavers:



1. We're the most trusted and respected data recovery specialists.
2. 24-hour, onsite, and weekend service available.
3. Proprietary techniques so advanced we retrieve data others might simply abandon.
4. Over 12 years of data recovery experience.
5. Certified to maintain most drive warranties.
6. Featured by CNN, NextStep, C-Net, Forbes.
7. All storage devices; Mac OS, DOS, Win95, WinNT, OS/2, UNIX, Sun, SGI, Novell.

©1997 DRIVESAVERS, INC.

Clip and save this ad. Visit DriveSavers at: www.drivesavers.com

DRIVESAVERS, INC. 400 BEL MARIN KEYS BLVD., NOVATO, CA 94949, INTL: 415-382-2000, FAX: 415-883-0780

MEMORY

"Computer Show" Prices Everyday!

Mohawk Memory Co., Inc.

SIMMS ♦ DIMMS ♦ EDO ♦ ECC ♦
VRAM ♦ CACHE ♦ PRINTER ♦
SDRAM ♦ POWERBOOK

Fax: (978) 897-0009

Email: simdim@mohawkmem.com

Webstore: www.mohawkmem.com

16A Waltham St. Maynard MA 01754
Visa MC Discover AMEX PO's O.A.C

1(800) 986-6429

Good Old-Fashioned New England Service



WHY IS THE COMPETITION SHAKING?

BECAUSE
1-800-4-MEMORY
IS HERE

WE CAN BEAT

ANY QUOTED PRICE ON ANY
MEMORY FOR ANY COMPUTER
(NOTEBOOK, DESKTOP,
PRINTERS) ANYWHERE ...
PERIOD!

- LIFETIME WARRANTY
- FREE TECH SUPPORT
- NO CREDIT CARD SURCHARGE
- MOST ORDERS SHIPPED SAME DAY

CALL AROUND THEN CALL US

CHECK OUR WEB SITE FOR SPECIALS
WWW.18004MEMORY.COM

Digital Imaging

- Slides & Negatives \$3.75
 - 4x5 Chromes/Negs \$30
 - Large Posters & Displays \$45
 - Scanning: Hi & Lo Res
 - Photo CD Scans & LVT Output
 - Short Run 1200 dpi Color Output
 - Quantity Prints, Slides, Overheads
- Show & Tell 39 W 38th St., NY, NY 10018
212 840-2912 • 212-840-7953 (fax)

Choose 437 at www.macworld.com/getinfo

data

When you absolutely, positively have to get your data back...

Be assured MicroCom will guide you through the recovery process... Diagnostic reports back to you within hours, with step-by-step updates on every recovery situation. Call now for an immediate consultation.

MICROCOM
20802 Plummer St. Chatsworth, CA 91311 • 818 718-1200
800 469-2549



www.mcrecovery.com

recovery



Data Memory Systems

800-662-7466
Shop 24hrs. On-line
www.datamem.com

- SIMMs
- DIMMs
- ECC Memory
- EDO Memory
- Notebook / Memory
- Digital Camera Memory
- Printer Memory
- CPU Upgrades
- VRAM (Macintosh)
- Hard Drives
- CD-ROM Drives
- PC-to TV Scanners
- Flatbed Color Scanners
- Notebook Batteries
- Sys. Bd. Clock Batteries
- Modems
- Monitors

Best Memory Prices!

VISA
MasterCard
Discover

LACIE
UMAX
FOCUS
GLOBAL VILLAGE COMMUNICATION
SAMPO
NEWTECH
iomega

Pentium Systems
Modems
EPSON
View
COLOR SCAN

Data Memory Systems
24 Keewqaydin Drive
Salem, NH 03079
Te: 603-898-7750
Fax: 603-898-6585
Email: sales@datamem.com

NEVER UNDERSOLD ON MEMORY!
We accept Commerical, Educational & Government P.O.s with Prior Approval

Choose 439 at www.macworld.com/getinfo

**WHOLESALE WATERLESS
COLOR PRINTING
FROM YOUR COMPUTER FILES**

1000 FULL COLOR BUSINESS CARDS FOR \$100 Sug. retail price \$179
1000 FULL COLOR POSTCARDS FOR \$149 Sug. retail price \$249

Printed waterless at 300 line screen from your computer files on Super Premium 10pt. Kromekote with our FREE scratch-resistant aqueous coating.



**Try Our
Fast 4/C Print
Quotes!**

- BUSINESS CARDS
- POSTCARDS
- CD INSERTS
- CD TRAY LINERS
- BROCHURES
- BOOKLETS
- NEWSLETTERS
- POSTERS & MORE



MM&M Advertising
1350 S. King Street
Suite 230
Honolulu, Hawaii 96814
Toll Free: 1-800-928-6623
Phone: (808) 593-2939
Fax: (808) 593-2132
E-Mail: MMAdv@aol.com



Frank S. Hooton
Account Executive

**FEATURING 300 LINE SCREEN
WATERLESS OFFSET PRINTING**

Rates for Brochures, Booklets and Flat Sheets are also available.

4-COLOR WATERLESS SPECIAL **1,000 18" x 24" POSTERS** **\$1299**
Printed 4/0 from your files on 100 lb. gloss text.
Price includes full bleed and FREE aqueous coating.
Get 2,500 for only \$1,699
SHIPPING NOT INCLUDED SUGGESTED RETAIL \$1,999

GRAPHIC ARTS
AVAILABLE



PRINTERS, INC.
4413 82nd Street • Lubbock, TX 79424 • FAX: 806.794.1305

Email your requests for printing quotes to request@copycraft.com

1.800.794.5594

CALL TODAY FOR A **FREE** COPY OF OUR **NEW 28-PAGE FULL COLOR CATALOG**

Visit www.copycraft.com for more 4-Color Specials!

**1000 ultra-thick full color
business cards \$60!**

Full color, thick stock and glossy UV coating included!

Ready in 5-7 workdays from your digital file!

Call now for a **FREE** sample kit!

800 957-5787
www.postcardpress.com

New! **500 full color postcards!**



POSTCARD PRESS

Data Recovery in hours.

- Over 10 years of experience with clients worldwide including Apple, NASA, HP, and FedEx.
- We've recovered more than half-a-million megabytes of Mac Data alone.
- You only pay when there's a recovery.
- Express One-Day Service is available.
- Call 24 hours a day.



LAZARUS
DATA RECOVERY

Working at the speed of business.

800-341-DATA

415-495-5556 • FAX 415-495-5553 • RESTRICTIONS MAY APPLY
381 Clementina Street • San Francisco, California 94103

Choose 444 at www.macworld.com/getinfo

**PROFESSIONAL
DATA RECOVERY
SERVICES.**

Hard Drives, Floppy Drives, Syquest, EZ-135, ZIP, JAZ, Optical & Bernoulli.

TOTAL RECALL
THE DATA RECOVERY COMPANY™



800 743-0594 VISIT US AT... www.recallusa.com

2462 WAYNOKA ROAD • COLO. SPRINGS, CO 80915 • TEL (719) 380-1616 • FAX (719) 380-7022

Choose 441 at www.macworld.com/getinfo

MAC REPAIR & UPGRADE

24 HOUR SERVICE TURNAROUND • LONGER WARRANTY
FREE DIAGNOSTIC • COMPETITIVE PRICE



**DT & T
MACINTOSH
SERVICES, INC.**

- * Specialize in component repairs:
 - Power Mac • Power Book • Logic boards
- * Advance Exchanges

800-622-7977

720 East Evelyn Ave., Sunnyvale, CA 94086 • Tel: 408-720-9899 • Fax: 408-720-9459
<http://www.dttservice.com>

Choose 443 at www.macworld.com/getinfo

DATA RECOVERY

For **MAC** - (Hard Drives, Opticals, Removables)

By Nick Majors' **DATA RECOVERY LABS**

"The Best Data Recovery Service available
- Anywhere - at any Price!"

Dedicated in-house **MAC** specialists are available to work on your emergency data recovery. Complete facility with clean rooms and full **MAC** capabilities.

Free evaluations. All recoveries are 100% satisfaction guaranteed. Complicated / top priority projects are our specialty.

Datarec.com
DATA RECOVERY LABS

USA • Canada • Japan • Brazil

1-800-563-1167
www.datarec.com



PLUG IN!

Create Your Own Full Color Custom Promotional Cards To Market Your Business, Products & Services • Feature Websites, CDs & New Technology • Ideal For Mailers, Self-Promotion, Invitations & More! • Call Now For More Information & Free Samples!



Full Color
Promo Cards
\$95
500 copies

Modern Postcard™
1-800-959-8365
www.modernpostcard.com

©1993 Modern Postcard. All rights reserved.

Great Prices!



Visit our web site...we offer direct to press on our Indigo, Heidelberg, & Xerox Docucolor. Also, big digital posters, Pro/Master PhotoCD, & Fuji Color Pictography Prints. Our expert Special Services Teams will ensure that you're pleased with your work.

Use The Best!

Send PC/Mac files by FTP or Priority Air Express to Imagers and for most output services, your finished work is in your hands the very next morning.

We guarantee our work!



Digital Production Center
Go online for tech help, quotes, ordering!
800.672.7029/404.351.5800

1575 Northside Dr. Ste. 490 Atlanta 30318
www.imagers.com

Choose 446 at www.macworld.com/getinfo

DEADLINES?

www.regentdigital.com

Fast & affordable Indigo & Heidelberg Digital Printing
Visit our web site for prices and file transfers.
or call toll free 1-888-999-2638

DIRECTORY

RELIGION

ONLINE BIBLE CD

Users say "It's simply the best!" • "Fast, Full Featured and Affordable..." • "The standard by which all others are judged" NIV • NASB • NKJV • NRSV • KJV w/Strong's + more Lexicons, X-Refs, Topics, Dicts, Commentaries, Maps Text in over 21 foreign languages including Greek & Hebrew

Deluxe CD \$90 • Classic CD \$40

BY THE BOOK, LLC. • 800-554-9116

3900 E Grace Blvd, Highlands Ranch CO 80126-7801
www.btbook.com • support@btbook.com

Choose 437 at www.macworld.com/GetInfo

COMPUTER INSURANCE

INSURES YOUR MAC

The ComputerownersSM insurance policy repairs or replaces hardware, media and purchased software. \$49 a year covers up to \$2,000 of equipment against theft, fire, accidents, power surge, natural disasters and more! \$50 deductible. Call for immediate coverage or information. 1-800-800-1492.

SAFEWARE, The Insurance Agency, Inc.

5620 N. High Street, PO Box 656
Columbus, Ohio 43085

Choose 440 at www.macworld.com/GetInfo

GENEALOGY SOFTWARE

REUNION[®] 5

"SPECTACULAR" MacWorld, 1/98; "FREAKIN' AWESOME" by MacAddict 2/98. Enter information easily. Link photos, sound, & video. Create large wall charts, reports, mailing lists, anniversary and birthday calendars. Share your family information on the web. To order, call MacWarehouse 800-255-6227. Visit our Web site: www.LeisterPro.com

LEISTER PRODUCTIONS, INC.

P.O. Box 289 Mechanicsburg, PA 17055
tel: (717)697-1378 • e-mail: info@LeisterPro.com

Choose 437 at www.macworld.com/GetInfo

CLIP ART

GET FREE CLIP ART!

3000 Image Mega Pack FREE from Nova Development! Premium-quality color clip art ideal for beginners and experts. Fully scalable, compatible with all popular word processing, graphics and desktop publishing programs. Guaranteed to print perfectly on all printers (B&W or color) Mention Code 617 to get this CD for \$4.95 S&H.

NOVA DEVELOPMENT CORPORATION

800.395.6682-US or Canada/818.591.9600-Outside

Choose 444 at www.macworld.com/GetInfo

CLARISWORKS 5.0 SPECIAL

ClarisWorks 5.0 Bundle—Only \$59.95!

Includes ClarisWorks 5.0, 10 issues of the ClarisWorks Journal and free membership in the ClarisWorks Users Group. (A \$139 value.) Add \$5 s/h (USA), \$10 s/h (Canada), \$15 s/h elsewhere. Credit cards accepted. Specify Macintosh or Windows. Electronic delivery of the ClarisWorks Journal outside the USA.

CLARISWORKS USERS GROUP

Box 701010, Plymouth, MI 48170
(888)781-CWUG; Fax: (734)454-1965; <orders@cwug.org>

Choose 445 at www.macworld.com/GetInfo

MacTECHS

INTERNATIONAL

Macintosh Repair, Sales & Upgrades

24 Hour Turnaround

Powerbook Specialists

Component Level Repair

Great Memory & Hard Drive prices

3337 El Camino Real
Palo Alto, CA 94306
Phone: 650.845.6400
Fax: 650.845.6411
www.mactechsinc.com

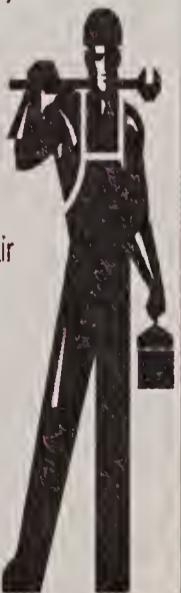

1-888-622-3493

WE GET TO THE CORE OF THE PROBLEM!



LinuxWorld™

CONFERENCE & EXPO

Linux Takes Center Stage!

KEYNOTE SPEAKER: Linus Torvalds, Creator of Linux
March 2, 1999 ■ 6:30 PM -7:30 PM



Introducing LinuxWorld
Conference: March 1-4, 1999
Expo: March 2-4, 1999
San Jose Convention Center
San Jose, CA

Now Linux has a brand-new show of its own. LinuxWorld Conference & Expo makes its debut March 1, 1999. It's going to be a blockbuster, because the Linux OS is the most talked-about technology in the IT industry. Attend LinuxWorld at the San Jose Convention Center and prepare to step into your own starring role in this rapidly emerging industry!

Geared to developers, enthusiasts and professional end-users, the Conference program will feature issues and solutions focused on Linux technology. There will be fifteen pre-conference tutorials and over 40 conference sessions. Attendees will include IS managers and decision-makers from Fortune 1000 companies, Linux developers, ISVs, VARs, OEMs and system administrators. The Expo will feature more than 100 emerging companies and organizations dedicated to Linux products and services.

Reserve your seat now! For more information, complete and fax or mail the coupon or visit:

www.linuxworldexpo.com

On the Web site, you'll get the latest updates, including conference session descriptions, show highlights, the exhibitor list, and more.

YES! Tell me more about
LinuxWorld Conference & Expo '99
 in San Jose. I'm interested in

Attending Exhibiting

Name _____

Title _____

Company/Organization _____

Address _____

City/State/Zip _____

Phone _____ Fax _____

email _____

Mail to:
 LinuxWorld Conference & Expo
 P.O. Box 339
 West Bridgewater, MA 02379
 FAX: 508.620.6668

MCW

Flagship Sponsor: **Linux** **LINUX**™ Owned and Managed by:

WORLD

JOURNAL

IDG
 WORLD EXPO

Media Sponsor:

INFO
WORLD

Media Sponsor:

Macworld



Moscone Convention Center

San Francisco, CA

- ▶ **EXHIBITS:** January 5-8, 1999
- ▶ **WORKSHOPS:** January 4, 1999
- ▶ **MACWORLD/PRO CONFERENCE:** January 5-7, 1999
- ▶ **MACWORLD EXPO USERS CONFERENCE:** January 6-8, 1999

For information on the Gaming Area, to enter the Championship, check schedules, tournaments and participating companies, visit the MACWORLD Expo Web site at: www.macworldexpo.com or call (800) 645-EXPO.

Discover what the future holds at MACWORLD Expo/San Francisco. Register on-line today at www.macworldexpo.com

At MACWORLD Expo/San Francisco, you will demo, touch, see and feel all the hot new products from more than 400 leading vendors. Learn time-saving productivity secrets through in-depth workshops and advanced and user-level conference programs.

Register on-line by December 4, 1998 and you will automatically be eligible to win two FREE airline tickets! Visit the Web for official rules and regulations.

Sponsored by:

Macworld

«eMediaweekly»

MacWEEK.com

Managed by:



Macworld

iMacworld

MacSoft®

P R E S E N T S



THE MACWORLD EXPO GAMING EXHIBITS

The MACWORLD Expo action-packed show floor will feature a Special Interest Environment devoted to Macintosh Gaming and featuring products from MacSoft, Bungie, Freeverse, Micro Conversion and many more. The Gaming Area will showcase the latest gaming titles and environments for the iMac and other Macintosh products. A retail store will be available to purchase products at tremendous special show discounts.



The ultra-successful MACWORLD Expo National Gaming Championship debuts in San Francisco! Entrance into the Championship is free to MACWORLD Expo attendees and allows you to demo, compete and win prizes with the latest Mac game titles.

For detailed information on the MACWORLD Expo Macintosh Gaming and Exhibits area, visit the Web at: www.macworldexpo.com/mwsf99/special/frame.html

Produced by:

DOUBLE EXPOSURE Inc.

VISIT: www.macworldexpo.com

CALL: 800-645-EXPO

YES! PLEASE SEND ME MORE INFORMATION ABOUT MACWORLD EXPO/SAN FRANCISCO! I'M INTERESTED IN:

Attending

Exhibiting

MPG

Name _____

Title _____

Company _____

Address _____

City/State/Zip _____

Phone _____ Fax _____

email _____

(if you would like to receive information via email about MACWORLD Expo)

Mail to: MACWORLD Expo, 1400 Providence Highway, P.O. Box 9127, Norwood, MA 02062. Or Fax to: 781-440-0357

THIS IS NOT A REGISTRATION FORM.



DARK VENGEANCE™

In a **dazzling 3D world** that dwarfs everything except your burning hatred, you must master three **radically different styles** of combat. **Three unique paths.** More than 30 weapons. Reap retribution in **32-player deathmatches.** Immersed in incredible **lighting and particle FX**, you have three golden chances to make the bastards pay. **Treasure them.**

vengeance will be yours. a bold new odyssey of combat and exploration.

Available at your local retailer, or visit the GT Interactive online store:
<http://www.gtstore.com> or call 800/229-2714

Dark Vengeance™ ©1998 Reality Bytes, Inc. All Rights Reserved. Reality Bytes and the Reality Bytes logo are registered trademarks, Dark Vengeance and the Dark Vengeance log are trademarks of Reality Bytes, Inc. Distributed and published by MacSoft, an affiliate of GT Interactive Software Corp. All other trademarks are the property of their respective companies.

Choose 28 at www.macworld.com/getinfo

MacSoft®

An affiliate of GT Interactive Software Corp.
www.wizworks.com/macsoft/



COMIN' AT YA

by Christopher Breen



Games feeling flat? Immerse yourself in the action with 3-D-acceleration hardware.

F

act: The world is not flat. This notion, pretty well settled for the general population in the fifteenth century, seemed only to have reached the computer gaming world a couple of years ago. Until this obvious idea dawned on game designers—and, not coincidentally, until computers became powerful enough to do something about it—game environments were not only flat but pixelated to boot. No longer.

Thanks to advances in games and the hardware that runs them, many modern Mac games are visual delights. Not only are environments more expansive but games now also boast special effects such as fog, realistic shadows, reflective surfaces, and shimmering liquids. And best of all, there are no more blocky pixels—these worlds are smooth as silk.

The key to these improvements is hardware

Now on the Mac!

TOMB RAIDER STARRING LARA CROFT II



Who says "Boys
shouldn't
play with
dolls"?



Now available at all
major retailers or call:
1-888-212-7797



W W W . A S P Y R . C O M

EIDOS
INTERACTIVE
www.eidosinteractive.com



Westlake
INTERACTIVE

Choose 90 at www.macworld.com/getinfo

Tomb Raider II, Lara Croft and her likeness and Eidos Interactive are trademarks of Core Design and Eidos, Plc respectively © 1997 1998 Eidos and Core.
The Aspyr Media logo is a trademark of Aspyr Media, Inc.
The Westlake Interactive logo is a trademark of Westlake Interactive, Inc.
All other trademarks are the property of their respective holders

acceleration for displaying 3-D graphics—achieved via dedicated processors that blast pixels and polygons to your monitor as quickly as possible.

Without 3-D-acceleration hardware, a game's graphical duties are left to the Mac's main processor—a processor that's already tasked with running the game, managing audio, and keeping track of where you've moved your joystick, all while doing heaven knows how many unrelated system-level housekeeping chores. With 3-D-acceleration hardware in place, the Mac can hand off these processor-intensive graphics tasks to this specialized graphics chip set. Without 3-D-acceleration hardware, games still work, of course, but they might not run as quickly and they certainly aren't as attractive.

The Standard Issue

Hardware isn't the only important factor in 3-D gaming. Another is the 3-D standard—or API (Application Programming Interface)—employed by the game and supported by a particular chip set. Currently two standards are commonly used in Mac games that support 3-D-acceleration hardware: QuickDraw 3D RAVE (Renderer Acceleration Virtual Engine), from Apple (www.apple.com), and Glide, an API developed by 3Dfx (www.join3dfx.com). Generally, RAVE games run on some variety of ATI Technologies' Rage chip set—the Rage II, Rage IIc, and Rage Pro—although video cards from other companies, including Mactell, support RAVE as well. Glide games work



Village Tronic MacPicasso 540 + 3D Overdrive

only with cards based on 3Dfx's Voodoo and Voodoo 2 chip sets.

Now that you know the basics, let's get down to the nitty-gritty: Is your Mac's on-board acceleration up to snuff, and if not, which acceleration hardware should you add to your system? To find the answer, Macworld Lab played two of today's most popular 3-D hardware-accelerated games—MacSoft's Quake and Unreal—using the built-in hardware acceleration of two Macs, as well as three PCI graphics-accelerator cards that offer either RAVE or Glide support installed on a Power Macintosh G3/266 with 128MB of RAM. Here's what we found.

Rage in the Machine

Let's get the sad-but-true facts of gaming life out of the way first: If you have built-in hardware acceleration based on anything less powerful than a Rage Pro—that means those of you with a first-generation iMac or Power Mac G3 or any earlier machine—

the RAVE version of Quake performs so poorly as to be unplayable, and Unreal refuses to run its RAVE driver at all. Quake performance on a G3 that has a built-in Rage II chip set and on the iMac with its Rage IIc chip set is lackluster, and because the Rage II doesn't support shadows adequately, large areas of the game's environment are overly dark. (At press time, Apple announced that the iMac now includes the ATI Rage Pro chip set with 6MB of dedicated RAM. This update should bring the iMac's performance in line with the Xclaim VR card tested in this story.)

If you have a Mac with on-board Rage II-based hardware acceleration, you can play the nonaccelerated versions of these games—provided that your Mac meets the games' system requirements, of course—but if you want to play the hardware-accelerated versions, you have to purchase a separate 3-D-acceleration card. iMac users, unfortunately, are pre-



Micro Conversions Game Wizard

cluded from doing so by the iMac's lack of a PCI slot. (Of course, Quake and Unreal aren't the only games in town.

3-D-Accelerator Cards

| Accelerator Card | Company | Phone | Price | Specs | Comments |
|-------------------------------|-------------------|--------------|------------|---|---|
| Game Wizard | Micro Conversions | 817/468-9922 | \$349.00* | 12MB of RAM, Voodoo 2 chip set, Glide support | Offers beautiful rendering and the fastest 3-D-accelerator hardware available for the Mac. |
| MacPicasso 540 + 3D Overdrive | Village Tronic | 800/317-7217 | \$549.95 | 4MB of RAM, Voodoo chip set, Glide support | Very good rendering and reasonably fast, but you need both the MacPicasso and the expansion card, which makes the package too expensive for gamers. |
| Xclaim VR | ATI Technologies | 905/882-2600 | \$299.00 | 4MB of RAM, Rage Pro chip set, RAVE support | So-so rendering; card is fine for Quake but not the best choice for Unreal. |
| REFERENCE SYSTEMS | | | | | |
| iMac | Apple Computer | 408/996-1010 | \$1,299.00 | Rage IIc chip set, RAVE support | Rage IIc is a hybrid between Rage II and Rage Pro chip sets, running faster than Rage II. |
| Power Macintosh G3/266 | Apple Computer | 408/996-1010 | \$2,129.00 | Rage II chip set, RAVE support | New desktop G3 systems feature a Rage Pro chip set. |

*8MB version, \$299.

ARNOLD TIOSEDO

SEE THE DIFFERENCE

As you can clearly see from these screen shots, the Voodoo 2 chip set found on Micro Conversion's 12MB Game Wizard card produces more-detailed graphics. Note the Game Wizard's finer gradations around the light sources, as well as the blending of textures on the floor and gun. Compare the Voodoo 2 and Rage Pro graphics with those of the software-rendered version of Unreal to see the benefits of 3-D-acceleration hardware.



Software only



Rage Pro



Voodoo 2

Hardware-accelerated games such as Bungie Software's Weekend Warrior, Pangea Software's Nanosaur, and Activision's MechWarrior 2 run perfectly well on a Rage II.)

ATI's (www.atitech.com) Xclaim VR Rage Pro card fared better than the Rage II in both our objective and subjective testing. RAVE games were not only faster with the Rage Pro but they looked better as well. Shadows, for example, while not adequately supported on the Rage II, look fine on the Rage Pro. This makes a big difference in a game such as Quake where, without shadows, you lose much of the game's atmosphere.

Yet despite the Rage Pro's advances over the Rage II, we found that the Rage Pro still does not perform exceptionally well in Unreal. In our test, the Rage Pro chip set found on ATI's Xclaim VR card was able to churn out only 8 frames per second in Unreal's opening flyby scene (see the benchmark, "3-D-Accelerator Tests"). Although you can improve this frame rate by reducing the quality of the graphics from within the game's Options window, you'll miss out on Unreal's flashier visual elements.

The Rage Pro card proved far better at accelerating Quake, thanks to Quake's less demanding graphics requirements. The Rage Pro-based Xclaim VR produced a very smooth 22 fps.

The Voodoo You Do

While RAVE-supported games are definitely a big step up from the plain-vanilla software-accelerated versions, games that support 3Dfx's Glide API, running on a card with the Voodoo or Voodoo 2 chip set, will knock you out.

Once you play these games with a Voodoo card, you'll be hard-pressed to go back to anything else. Textures are beautifully smoothed, fog and smoke shroud the landscape, coronas appear around light sources, liquids shimmer, and frame rates increase. Although cards that support RAVE produce many of these same textures and lighting effects, they fail to do so as convincingly and quickly as

Voodoo cards. The Voodoo-based card we tested—Village Tronic's (www.villagetronic.com) MacPicasso 540 + 3D Overdrive—produced Unreal frame rates that hovered around a reasonably playable 18 fps on our test machine. In Quake these frame rates shot up to a smooth-as-silk 26 fps. Voodoo-based acceleration cards produce similar results regardless of whose



ATI Technologies' Xclaim VR

name adorns the card. You won't, however, see similar results between a card based on the original Voodoo chip set and one that sports 3Dfx's latest offering, the Voodoo 2.

We had an opportunity to examine just such a Voodoo 2 chip set in Micro Conversions' (www.microconversions.com) 12MB Game Wizard and were dazzled by the results. We're talking 31 fps in Unreal and a screaming 48 fps in Quake running at a resolution of 640 by 480 pixels. That 12MB of on-board RAM allowed us to increase Quake's screen res-

GAMES AND STANDARDS

What good is 3-D-acceleration hardware without games to go with it? Here's a list of games and the APIs they support.

| Game | Company | Glide Support | RAVE Support |
|------------------------|---------------------|---------------|--------------|
| Carmageddon | Aspyr Media | ● | ○ |
| Dark Vengeance | MacSoft | ○ | ● |
| F/A-18 Korea | Graphic Simulations | ● | ○ |
| Havoc | Reality Bytes | ○ | ● |
| MechWarrior 2 | Activision | ○ | ● |
| Myth: The Fallen Lords | Bungie Software | ● | ○ |
| Myth II: Soulblighter | Bungie Software | ● | ● |
| Nanosaur | Pangea Software | ○ | ● |
| Quake | MacSoft | ● | ● |
| Shadow Warrior | MacSoft | ● | ○ |
| Tomb Raider II | Aspyr Media | ● | ●* |
| Unreal | MacSoft | ● | ●* |
| Weekend Warrior | Bungie Software | ● | ● |

● = yes; ○ = no. *Rage Pro or better.

F/A-18

KOREA

HIGH - REALISM STRIKE FIGHTER SIMULATION

The latest in hardcore realism from the engineers of the award-winning F/A-18 Hornet 3.0

FEATURES:

- * Proprietary ultra high-speed differential scan conversion graphics engine
- * Native 3Dfx* texture mapping and effects
- * Powerful mission creator/editor
- * Highly realistic carrier operations
- * Detailed printed/online documentation
- * Extensive theater of ops with rolling terrain
- * Authentic avionics and flight modeling
- * Network play over LAN or Internet
- * Huge arsenal, including B-57 tactical nuke!
- * Written for Macintosh!



SPECIAL OFFER

FOR A LIMITED TIME!!!

TWO OF THE
GREATEST SIMS EVER -
BOTH FOR ONLY \$29.95
Available online or in stores.



Check out our web page at:
www.graphsim.com

GRAPHIC
SIMULATIONS
CORPORATION

*3Dfx texture mapping requires compatible 3D Hardware.

Choose 91 at www.macworld.com/getinfo

olution to 800 by 600, and even at this more demanding resolution, Quake ran at 31 fps. Additionally, Micro Conversions promises that this card—and its 8MB sibling—will also run RAVE games. Regrettably, the RAVE drivers were unfinished at press time, but they should be available for download by the time you read this.

NE 3D

Incidentally, if you want to play Glide-supported games on your Mac, it's also possible to use a Voodoo card intended for use with a PC.

The trick is to use the proper drivers and pass-through video cable. Griffin Technology (615/255-0990, www.griffintechnology.com) supplies the latter in its \$15 NE 3D kit. Included in the kit are the pass-through cable, a monitor adapter, a CD-ROM with helpful utilities, and instructions on where to find the latest Macintosh Voodoo drivers on the Internet.

Macworld's Buying Advice

Our objective and subjective tests agree: If you're serious about games, desire the best graphics a game has to offer, have a Mac with a full-size PCI slot, and want



3-D-Accelerator Tests

Best results in red. Reference systems in italics. Test results are in frames per second.

| | Quake Frame Rate | Unreal Frame Rate |
|--|------------------|-------------------|
| ATI Xclaim VR | 22 ^A | 8 ^A |
| Micro Conversions Game Wizard | 48 ^B | 31 ^B |
| Village Tronic MacPicasso 540 + 3D Overdrive | 26 ^B | 18 ^B |
| Apple iMac | 12 ^C | D |
| Apple Power Macintosh G3/266 | 9 ^C | D |

Longer bars are better

^A Running RAVE version of game. ^B Running Glide version of game. ^C RAVE with shadows turned off.
^D Won't run in hardware-accelerated mode.

Behind Our Tests

All products were tested using timed demo routines that indicate how many frames per second are displayed on average in MacSoft's Quake and Unreal. Resolution was set to 640 by 480 pixels in 16 bits, and Unreal's default settings for both RAVE and Glide were used. Because Unreal's memory requirements are extreme (at least 80MB of RAM), the G3/266 was configured with 128MB of RAM so that virtual memory wouldn't be a factor.—Macworld Lab testing supervised by Jeffy Milstead

hardware acceleration right this minute, a Voodoo card of some stripe should be in your Macintosh—assuming you can live with the relatively small number of titles that support such cards. If you're willing to wait, you should see some exciting developments in 3-D-acceleration hardware over the next few months

(see the sidebar "Down the Pike"). Regardless of whether you buy now or later, one thing's certain: 3-D-acceleration hardware is your ticket to greater gaming glory. **m**

CHRISTOPHER BREEN coauthored *The Macintosh Bible Guide to Games* (Peachpit Press, 1996).

DOWN THE PIKE

THE MACINTOSH 3-D-ACCELERATION HARDWARE MARKET IS AT A crossroads. Previously, 3-D hardware acceleration was considered a nicety—a welcome adjunct to a game but hardly a necessity. That's changing. It's no secret that nearly every game now released for the Macintosh is a port of a PC product, and increasing numbers of these PC games now support 3-D-acceleration hardware. Mac users expect their games to look as good as those of their PC counterparts; therefore, Mac games must now also support hardware acceleration.

Although RAVE is a cross-platform API, it's not a major player in the PC gaming industry. For this reason, you'd expect RAVE to fade away on the Mac, but that doesn't appear to be happening. Two of this winter's hottest games—Aspyr Media's Tomb Raider II and Bungie Software's Myth II: Soulblighter—support both RAVE and Glide (see the sidebar "Games and Standards"). The reason for RAVE support is obvious. Although Voodoo boards currently produce better-looking games, far more Mac users have RAVE-compatible hardware, thanks to Apple's inclusion of the Rage chip set on current Macintosh models. This number is only likely to increase, and game vendors simply can't ignore this market.

Micro Conversions' Voodoo 2-based Game Wizard cards are just a hint of things to come. Other companies, such as TechWorks, are also working on Voodoo 2 accelerator cards. You should also soon see a Mac gam-

ing board based on 3Dfx's Voodoo Banshee chip—a graphics chip set that provides both 2-D acceleration and Voodoo 2-based 3-D acceleration on the same card. And for those who are looking for Voodoo on the cheap, Village Tronic should have released its \$99 MacMagic, an 8MB Voodoo card, by the time you read this.

But wait, there's more. ATI has recently released the Rage 128 chip set for the PC—a powerful set of processors that supports Direct 3D and OpenGL, two popular 3-D APIs for the PC. Given ATI's dedication to the Mac market, you should see comparable Mac-compatible Rage 128-based cards released in the near future. Expect these cards to support both RAVE and OpenGL.

With these new cards and the additional memory they'll carry, you should see significant improvements in gaming performance. Not only will frame rates increase but you'll also be able to play games at higher resolutions—1,024 by 768 pixels will become the new standard. Textures will be more complex and varied, and surfaces will be more realistic—water will ripple as well as shimmer.

And as hardware becomes more capable, game programmers will create games that take advantage of these capabilities. With faster and richer game play just around the corner, the future of Mac gaming looks bright indeed.

WE'VE GOT THE MAC MARKET COVERED

ON-LINE

MacWEEK.com

«eMediaweekly.com»

iMacworld

WWW.MACWEEK.COM

GET IT ALL HERE NOW -- NEWS, MAC THE KNIFE, MAC/BUSINESS AND MORE!

WWW.EMEDIAWEEKLY.COM

THE CENTRAL CLEARING HOUSE FOR NEWS AND INFORMATION IN THE DIGITAL PUBLISHING ARENA -- FEATURING OVER 500 LINKS!

WWW.IMACWORLD.COM

GAMES, GADGETS, GEAR -- IF IT'S FUN, YOU'LL FIND IT HERE!

Attention Marketers!
80,000+ Unique
Visitors/Day

7,000,000
Page Views/Month
We've got you covered!

Macworld
online

WWW.MACWORLD.COM -- WE'VE GOT IT ALL COVERED.

The Game Room

by Philip Dyer

Expand Your Options

IS PLAYING PC GAMES ON YOUR MAC WORTH THE HASSLE?

K NOW WHAT A MAC-intosh can do that a PC can't? If you said, "Maintain its owner's sanity," you'd be right! However, I was going for something a tad less caustic: Macs can emulate PCs, but PCs can't yet emulate Macs. Did you hear that? Do you realize what that means? If you own a Mac, you have access to all the software on either platform (including the latest PC-only games), right now, just by running a PC emulator. No longer do you have to stand outside the window of your mall's electronic-gaming boutique, drooling over the vast bounty of delectables beyond the glass—you can have them all right now!

At least, that's the theory.

PC emulation comes in two varieties: affordable (software) and not so affordable (hardware). The affordable stuff consists of Connectix's VirtualPC 2.1 (\$160; 650/571-5100, www.connectix.com) and Insignia Solutions' SoftWindows 98 (\$169 company's estimated price; 510/360-3700, www.insignia.com), two software packages that run Windows 98 right on your Mac. (Insignia also offers RealPC, a \$79 DOS-only version.)

The problem is that these packages are running an operating system within an operating system, which results in a performance hit. Orange Micro provides the only Pentium cards available, ranging in base price from \$549 to \$849 (714/779-2772, www.orangemicro.com). I put these software emulators and the lowest-priced Orange Micro card on a Power Mac G3/300 with 128MB of RAM to see how they stacked up.

I installed two PC-only games for the test: Microsoft's Age of Empires, which has the modest requirement of a 90MHz Pentium processor, and Activision's BattleZone, which requires a 120MHz Pentium processor but recommends at least 166MHz. Under software emulation, Age of Empires was playable although sluggish; BattleZone, on the other hand, was an exercise in frustration. You could buy a ton of RAM, reduce the game's display size, and turn off sounds

OrangePC 626. Tack a little extra onto that cost, since you'll want to replace the standard 16MB of RAM with at least 32MB. I pumped it up to 64MB for my tests.

The 200MHz Pentium card played Age of Empires smoothly, but BattleZone was much less enjoyable. Sure, it was playable, but it couldn't achieve anything close to smooth screen redraws. Orange Micro has announced a \$649 game card, the PCfx, that will ship with a 128-bit nVidia graphics accelerator. In addition, an \$849 version, the OrangePC 660, has the accelerator and two RAM slots, although you have to pay extra for RAM and Windows. Both cards were scheduled for release in November 1998.

OK, so here's the bottom line. Software PC emulators are fine for some of the simpler games that don't require a processor of more than about 90MHz, but they will never be a viable gaming option.

Orange Micro's Pentium cards offer a much better PC gaming solution, but at a much higher cost. The \$649 card (when it becomes available) should offer a nice compromise between price and performance for the serious gamer. If you don't want to spend that much to play the latest, coolest PC games, I'm afraid

you're stuck with the games that make it to the Mac platform.

The good news is, all indications are that the Mac gaming market is set to explode. Until that happens, spend some time exercising and communing with nature; once the Mac gaming market takes off, you won't have time for such luxuries. **m**

Senior Online Editor PHILIP DYER spends far too little time exercising and communing with nature.



and textures to get a stripped-down version of the game to limp along, but is all that really worth it? (Here's a hint: no.)

Intel Inside?

Orange Micro's Pentium cards are much better able to play PC games than their software siblings, but they do so at a cost. The only card that was ready by the time I conducted my tests was the least expensive of the company's three 200MHz cards, the \$549

continued from page 192

Andreotta, NASA's deputy CIO for operations. "Customers can select the platforms they want and the service they require."

That's good news to people like Joe Williams, rendezvous guidance and procedures officer. "I was worried when the Wintel standard was established," he says. "But I'm still using Macs in everyday activities, [including] support of shuttle flights. I'm the guy sitting in the front-center row of the Mission Control Center, the one with the PowerBook 5300cs."

BellSouth ADSL Service In May 1998, BellSouth announced the availability of ADSL (for Internet connections up to 100 times faster than modems) in 30 cities—for Windows only.

Mac fan Nathan Tennes helped to inspire BellSouth's reversal with a sly tactic: he pointed out to the local paper's technology columnist that his own, rival firm (Road Runner cable modems) *was* Mac friendly. The pressure was on.

When members of the Raleigh, North Carolina, Mac user group followed up by swamping BellSouth with calls, this story fell into its usual pattern: BellSouth admitted that the response

from Mac users had been enormous, way out of proportion to the supposed market-share numbers. In July, BellSouth and Apple published a joint press release. "By working directly with Apple," BellSouth said, "we are bringing the Mac version of BellSouth.net FastAccess ADSL service to market."

Santa Barbara Department of Continuing Education Not every Mac triumph involves a major corporation. When the Santa Barbara, California, Department of Continuing Education announced that it was about to replace its lab full of aging Macs with Wintel boxes, user-group member Harold Adams was appalled. He circulated a petition at the newspaper where he worked (the *News-Press*); within days, he had sheets full of signatures. "We let the community know how our local paper depends on Macintosh for daily productivity and output," he says.

The petition was submitted to the school board. Incredibly, Adams's simple demonstration that people *cared* resulted in new all-Mac labs, classes in Adobe Photoshop and FileMaker—and, in this era of a rebounding Apple, a community sense of having done the right thing.

The Battles Continue

Don't bother e-mailing me accounts of *lost* battles; I'm aware that the Mac isn't always victorious. But thanks to the polite but unbending pressure from those of us who know a superior machine when we see one, the Macintosh is unmistakably retaking lost ground in workplaces and schools all over the world. At my Web site, you'll find tale after tale of the Mac's resurgence after "cancellation" at such establishments as the National Institutes of Health and the Stanford Linear Accelerator; Winona State University, Texas Christian University, and the University of Waterloo (Toronto); and school systems in Rockford, Illinois; Sarasota, Florida; Des Moines; Malvern, Pennsylvania; Portland, Oregon; and Martha's Vineyard, Massachusetts.

I thought you'd want to know about these quiet, but significant, Macintosh victories. Because one thing's for sure: you won't read about 'em in *Business Week*. **m**

DAVID POGUE (www.davidpogue.com) is a co-author of *Macworld Mac Secrets*, fifth edition (IDG Books Worldwide, 1998).

Here in this issue!

Introducing a New Service to Readers...



www.macworld.com/getinfo

Macworld's **NEW** Online Reader Service

Introducing Get Info. Now you can get information on all the products and services you see in *Macworld*.

Only get it faster. Simpler. Better. Now. All you have to do is visit one site:

www.macworld.com/getinfo

Then select the products, product categories or advertisers for whom you want to receive information.

That's it. You can have the information delivered to you by e-mail, postal mail or even telephone. It's quick. Convenient. Fast. So next time you're interested in a product, don't get a stamp. Get Info.

The Desktop Critic

by David Pogue

First the Battles, Then the War

IF THE MAC IS DEAD, WE NEVER GOT THE MEMO

THE *WALL STREET JOURNAL* told us. *Fortune* told us. And Lord knows, *Time* magazine told us: Apple “has no future.” These publications’ ability to draw negative conclusions from any news, no matter how positive, often bordered on the Monty Pythonesque. You get the idea that if Apple won a 90 percent market share, bought out Microsoft, and hired Bill Gates to mop the bathrooms, *Business Week* would write: “Apple has all but ignored the possibility of alien invasion—an event that would cut deeply into profit margins.”

Once the media seized upon the Death of Apple as their favorite slow-news-day whipping boy, a cycle of anti-Mac feeling took hold among non-Mac users. One company after another announced Mac phaseouts. We heard about banks, telecom services, and even Web pages withdrawing Mac support.

Those announcements, naturally, made further headlines. But the Apple-obsessed media are missing a story that’s ten times juicier: that many of the much-hyped Mac phaseouts *never happened*. We’re talking about corporations, universities, and government departments completely reversing themselves, admitting bad judgment, and eating enough crow to make Thanksgiving look like a snack.

What brings about these amazing policy reversals? It’s the oldest and most reassuring story in the American book: the people spoke. Every phaseout triggers a tidal wave of resistance. Every Mac-bashing official gets a sharp, overwhelming lesson in the consequences of taking away choice. Eventually, the clueless get an education: People *care* about their Macs, and we’re willing to fight for our right to use them.

You’ve probably already heard how Intuit’s Quicken for the Mac was canceled, and then uncanceled in the face of

pressure from the public (and Steve Jobs) and how the Disney Blast Web site was incompatible with Macs until Mac customers pounded down the door. But those cases are only the tip of the iceberg.

Wells Fargo In July 1998, Wells Fargo Bank wrote to its customers: “Online banking through Quicken for Macintosh will be discontinued, since only a small number of our customers use this service.”

Or maybe not. Within five days, 700 customers wrote to complain. Mac fan Tom Chiara’s polite, no-nonsense letter was among them: “Many of us would rather switch banks than use Windows

availability of software . . . the University cannot guarantee support for Macintoshes beyond June 2000.”

This edict came from a tech director named Dan Updegrave, who apparently had visions of Intel equipment grants dancing in his head (see *The Desktop Critic*, March 1998). But the reaction was overwhelming: outraged alumni, students, faculty, and Yale grad schools rushed to denounce the policy—one that made absolutely no sense in an environment where Ethernet and Web connections are all that matters.

Updegrave never did apologize or retract his decree, but it didn’t matter; the university took matters out of his hands. “This year,” says Yale spokesperson Tom Conroy, “Yale made no recommendation to incoming students regarding what brand of computer to buy,” leaving students to make their own choices. This year’s letter to entering students, in fact, reads like an ad for Apple, prominently listing Mac systems for sale (as well as Windows machines).

Oh—and guess whose name *isn’t* signed to this year’s letter?

Johnson Space Center In 1996, John Garman, chief information officer of NASA’s Johnson Space Center, announced that the center would be going all Windows.

The ensuing controversy raged for two years on the Web, via e-mail, and in the nation’s newspapers. This one stung; after all, NASA is *government*, our tax dollars at work. A key question: Had Garman followed federal guidelines for choosing the most cost-effective solution?

But you don’t just tell the nation’s leading scientists and researchers that you’re taking away their favorite tools. Today, Garman is long gone, and NASA is buying more Macs. “There is no plan to standardize on one platform,” says Don



to access our account,” he wrote.

Wells Fargo was big enough to admit its mistake. “We goofed,” said the form letter Chiara received only 11 days later. “The service will not be discontinued as previously announced.”

Put one way, Wells Fargo’s original decision wasn’t surprising; only 1 percent of its online customers use Macs. But 1 percent is 7,000 Wells Fargo customers; for a bank, that’s quite a chunk of change.

Yale University In June 1997, Yale wrote to every incoming freshman: “You are strongly encouraged to select a Windows PC. Owing to uncertainties about

continues on page 191



Sometimes Newer Is Better Than New



Introducing the Latest Apple Desktop

So, you sprang the bucks for an Apple PowerBook G3 Series - a computer that's as comfortable on your desktop as it is on the road. Except, of course, for that #\$\$%?@&! mass of cables waiting on your desk. Not to worry. Newer Technology has created the BookEndz docking station. The easiest way to connect or disconnect a monitor, keyboard, mouse, audio in and out, network or serial printer, SCSI devices, and power in seconds flat. Snap in your G3 PowerBook and you have a world class desktop machine, snap it out and you have the ultimate portable. What else do you need?



 **newer**technology_™

To learn how to turn your PowerBook into a true desktop machine, visit us at www.newertech.com
(We'll also be at Booth 917 at the upcoming Macworld San Francisco. Come and see us!)

Choose 55 at www.macworld.com/getinfo

HOW'S YOUR SEARCH FOR MAC ACCESSORIES GOING?



Kensington, Mouse-in-a-Box, Turbo Mouse and Maccessories are registered trademarks and Orbit and Keyboard-in-a-Box are trademarks of ACCO World Corporation. All other registered and unregistered trademarks are the property of their respective owners. Kensington sells input devices that are compatible with Apple's Macintosh computers. ©1998 Kensington Technology Group, a division of ACCO Brands, Inc.

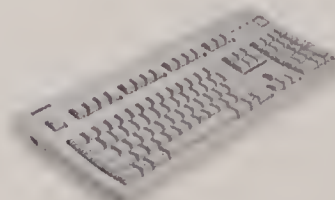

Hey, we know the places you can buy Macs and Mac stuff aren't exactly popping up like Starbucks these days. But we've got you covered. With high performance accessories like our TurboMouse[®] and Orbit[™] trackballs, easy-to-use Mouse-in-a-Box[®], and 2- and 4-button mice. And now there's our hot new Keyboard-in-a-Box[™]. You see, we've been making Apple products since 1981. And we're going to keep right on making them, until the Feds shut down Microsoft and Apple regains its rightful place as the king, the sovereign monarch, the mighty potentate of the cyberuniverse. Until then, check out the Maccessories[®] at www.kensington.com.

KENSINGTON

Smart design at work.

Choose 1 at www.macworld.com/getinfo